

ALL 304 S/S CONSTRUCTION.
 ALL WELDS ARE GROUND AND
 POLISHED TO A # 4 FINISH. BASES
 EQUIPPED WITH LEVELERS. DOORS
 TRACK ON 1" DIA NYLON ROLLER
 BEARINGS. TWO POINT ROD LOCKING
 DOOR HANDLES. (5) S/S ADJUSTABLE
 SHELVES ON 1/2" INCREMENTS.

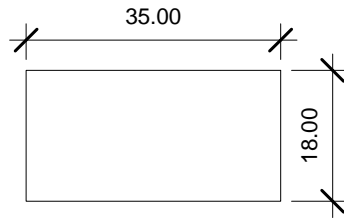

② Plan
 1/2" = 1'-0"

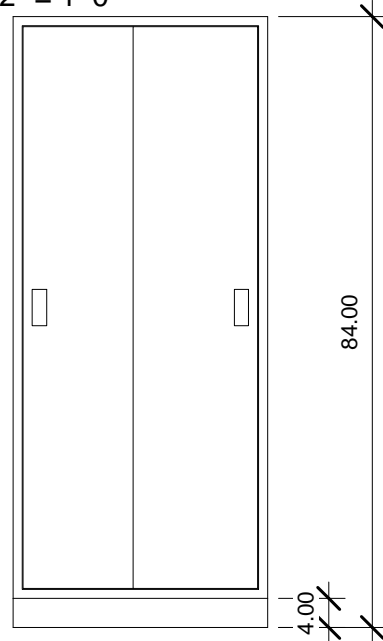

① Front
 1/2" = 1'-0"

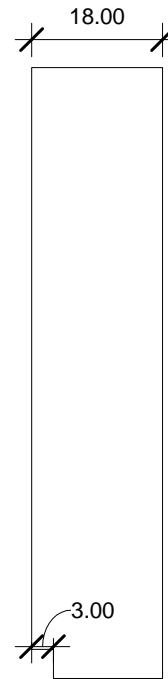

③ Right
 1/2" = 1'-0"

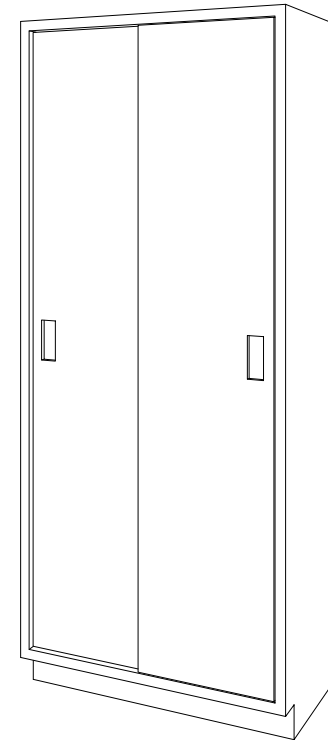

④ 3D View 1

PO#: _____ DATE: _____

APPROVAL: _____

TITLE: _____

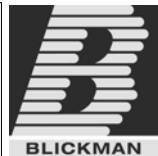

	NAME	DATE
DRAWN	JG	2-11-11
ENG APPR.		
MATERIAL		
304 S/S		
FINISH		
POL # 4		
APPRX WEIGHT = lbs 295 SHIPPING		
DO NOT SCALE DRAWING		

BLICKMAN HEALTH INDUSTRIES, INC. LODI, N.J.		
TITLE: J35HAS		
SOLID SLIDING DOORS HIGH CABINET		
SIZE	DWG. NO.	REV
A	2030535180	
SCALE: 1:16		SHEET 1 OF 1

PROPRIETARY AND CONFIDENTIAL
 THE INFORMATION CONTAINED IN THIS
 DRAWING IS THE SOLE PROPERTY OF
 BLICKMAN HEALTH INDUSTRIES. ANY
 REPRODUCTION IN PART OR AS A WHOLE
 WITHOUT THE WRITTEN PERMISSION OF
 BLICKMAN HEALTH INDUSTRIES IS PROHIBITED.

UNLESS OTHERWISE SPECIFIED:
 DIMENSIONS ARE IN INCHES
 BEND RADIUS = MTL THK.
 TOLERANCES:
 FRACTION: ± 1/32"
 DECIMAL: ± .031"

ALL 304 S/S CONSTRUCTION.
 ALL WELDS ARE GROUND AND
 POLISHED TO A # 4 FINISH. BASES
 EQUIPPED WITH LEVELERS. DOORS
 TRACK ON 1" DIA NYLON ROLLER
 BEARINGS. TWO POINT ROD LOCKING
 DOOR HANDLES. (5) S/S ADJUSTABLE
 SHELVES ON 1/2" INCREMENTS.

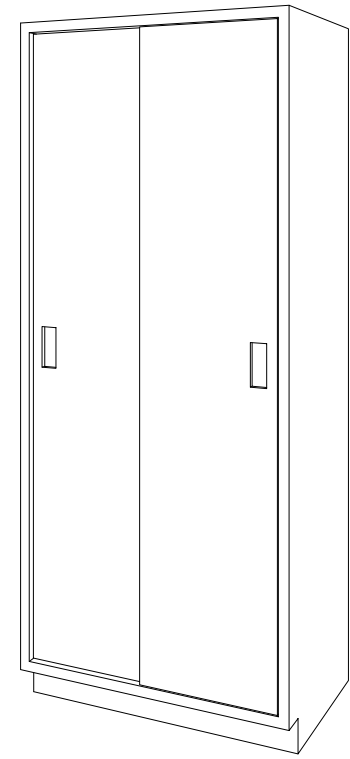
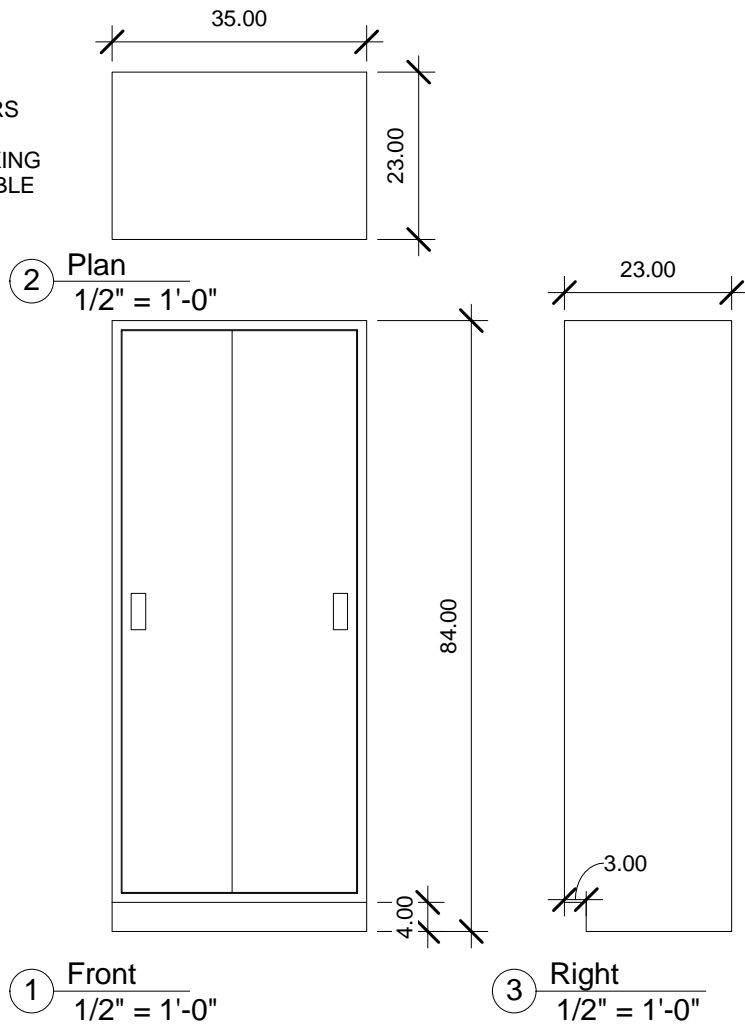

④ **3D View 1**

PO#: _____ DATE: _____

APPROVAL: _____

TITLE: _____



	NAME	DATE
DRAWN	JG	2-11-11
ENG APPR.		
MATERIAL		
304 S/S		
FINISH		
POL # 4		
APPRX WEIGHT = lbs 320 SHIPPING		
DO NOT SCALE DRAWING		

BLICKMAN HEALTH INDUSTRIES, INC. LODI, N.J.		
TITLE: J35HBS		
SOLID SLIDING DOORS HIGH CABINET		
SIZE	DWG. NO.	REV
A	2030535232	
SCALE: 1:16		SHEET 1 OF 1

PROPRIETARY AND CONFIDENTIAL
 THE INFORMATION CONTAINED IN THIS
 DRAWING IS THE SOLE PROPERTY OF
 BLICKMAN HEALTH INDUSTRIES. ANY
 REPRODUCTION IN PART OR AS A WHOLE
 WITHOUT THE WRITTEN PERMISSION OF
 BLICKMAN HEALTH INDUSTRIES IS PROHIBITED.

UNLESS OTHERWISE SPECIFIED:
 DIMENSIONS ARE IN INCHES
 BEND RADIUS = MTL THK.
 TOLERANCES:
 FRACTION: ± 1/32"
 DECIMAL: ± .031"

ALL 304 S/S CONSTRUCTION.
 ALL WELDS ARE GROUND AND
 POLISHED TO A # 4 FINISH. BASES
 EQUIPPED WITH LEVELERS. DOORS
 TRACK ON 1" DIA NYLON ROLLER
 BEARINGS. TWO POINT ROD LOCKING
 DOOR HANDLES. (5) S/S ADJUSTABLE
 SHELVES ON 1/2" INCREMENTS.

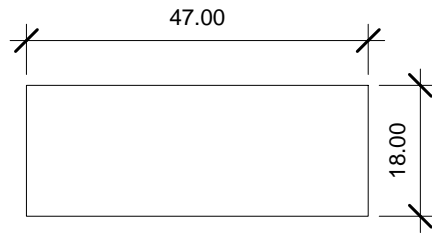

② Plan
 1/2" = 1'-0"

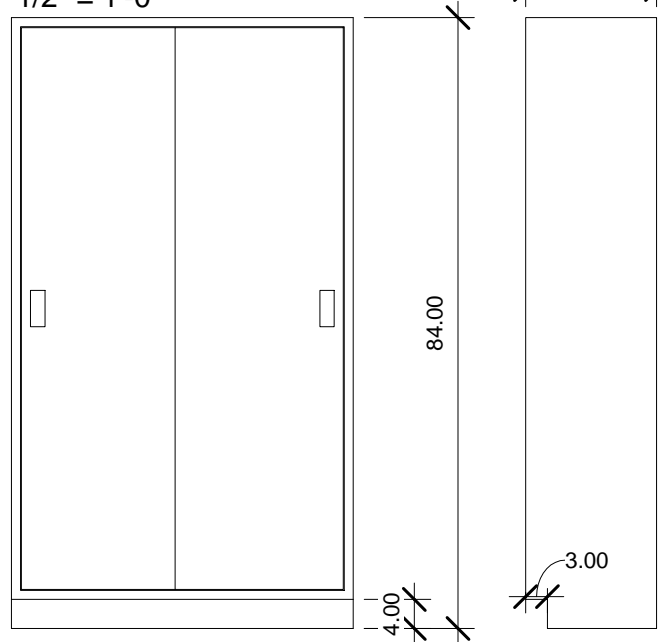

① Front
 1/2" = 1'-0"

③ Right
 1/2" = 1'-0"

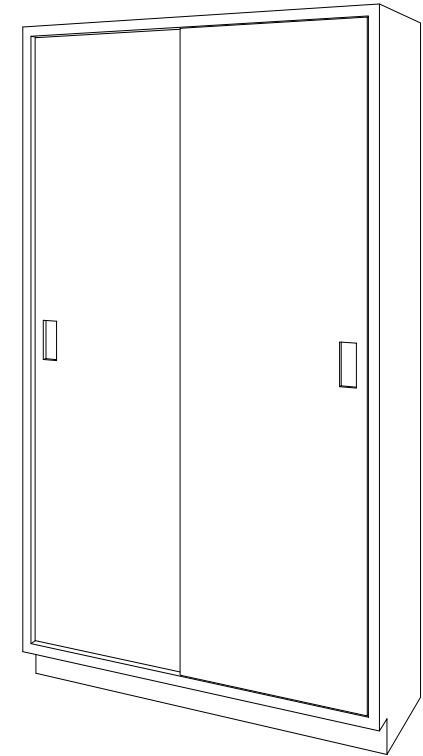

④ 3D View 1

PO#: _____ DATE: _____
 APPROVAL: _____
 TITLE: _____

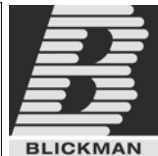

	NAME	DATE
DRAWN	JG	2-11-11
ENG APPR.		
MATERIAL		
304 S/S		
FINISH		
POL # 4		
APPRX WEIGHT = lbs 405 SHIPPING		
DO NOT SCALE DRAWING		

BLICKMAN HEALTH INDUSTRIES, INC. LODI, N.J.		
TITLE: J47HAS		
SOLID SLIDING DOORS HIGH CABINET		
SIZE	DWG. NO.	REV
A	2030547180	
SCALE: 1:16		SHEET 1 OF 1

PROPRIETARY AND CONFIDENTIAL
 THE INFORMATION CONTAINED IN THIS
 DRAWING IS THE SOLE PROPERTY OF
 BLICKMAN HEALTH INDUSTRIES. ANY
 REPRODUCTION IN PART OR AS A WHOLE
 WITHOUT THE WRITTEN PERMISSION OF
 BLICKMAN HEALTH INDUSTRIES IS PROHIBITED.

UNLESS OTHERWISE SPECIFIED:
 DIMENSIONS ARE IN INCHES
 BEND RADIUS = MTL THK.
 TOLERANCES:
 FRACTION: ± 1/32"
 DECIMAL: ± .031"

ALL 304 S/S CONSTRUCTION.
 ALL WELDS ARE GROUND AND
 POLISHED TO A # 4 FINISH. BASES
 EQUIPPED WITH LEVELERS. DOORS
 TRACK ON 1" DIA NYLON ROLLER
 BEARINGS. TWO POINT ROD LOCKING
 DOOR HANDLES. (5) S/S ADJUSTABLE
 SHELVES ON 1/2" INCREMENTS.

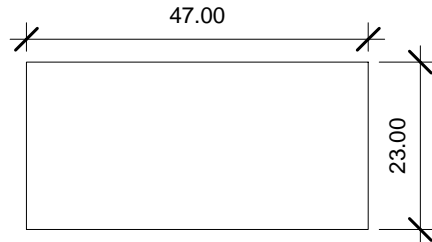

② Plan
 1/2" = 1'-0"

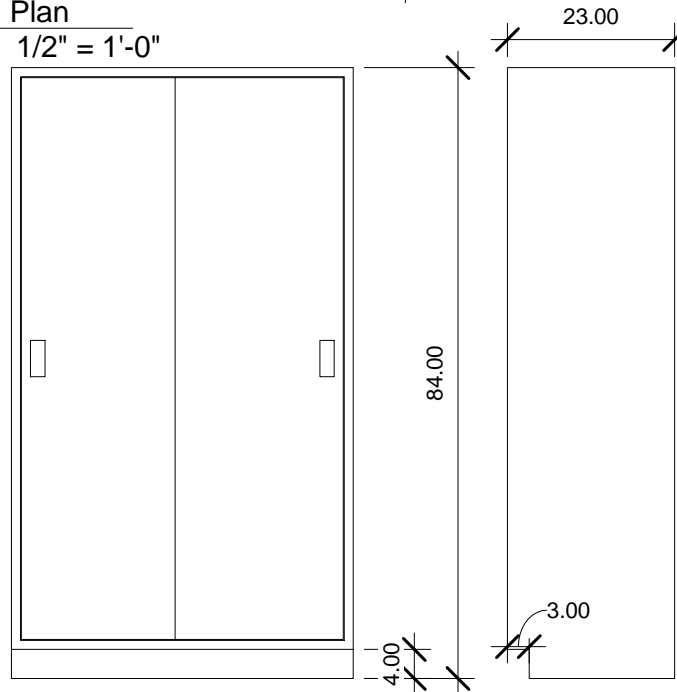

① Front
 1/2" = 1'-0"

③ Right
 1/2" = 1'-0"

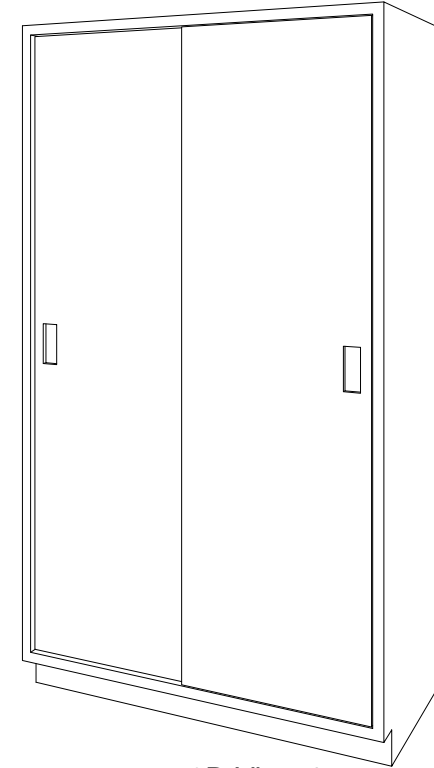

④ 3D View 1

PO#: _____ DATE: _____

APPROVAL: _____

TITLE: _____

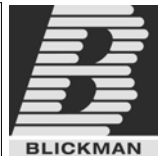

	NAME	DATE
DRAWN	JG	2-11-11
ENG APPR.		
MATERIAL		
304 S/S		
FINISH		
POL # 4		
APPRX WEIGHT = lbs 430 SHIPPING		
DO NOT SCALE DRAWING		

BLICKMAN HEALTH INDUSTRIES, INC. LODI, N.J.		
TITLE: J47HBS SOLID SLIDING DOORS HIGH CABINET		
SIZE	DWG. NO.	REV
A	2030547232	
SCALE: 1:16		SHEET 1 OF 1

PROPRIETARY AND CONFIDENTIAL
 THE INFORMATION CONTAINED IN THIS
 DRAWING IS THE SOLE PROPERTY OF
 BLICKMAN HEALTH INDUSTRIES. ANY
 REPRODUCTION IN PART OR AS A WHOLE
 WITHOUT THE WRITTEN PERMISSION OF
 BLICKMAN HEALTH INDUSTRIES IS PROHIBITED.

UNLESS OTHERWISE SPECIFIED:
 DIMENSIONS ARE IN INCHES
 BEND RADIUS = MTL THK.
 TOLERANCES:
 FRACTION: ± 1/32"
 DECIMAL: ± .031"