

ALL 304 S/S CONSTRUCTION.
 ALL WELDS ARE GROUND AND
 POLISHED TO A # 4 FINISH. BASES
 EQUIPPED WITH LEVELERS. (3) S/S
 FIVE KNUCKLE HOSPITAL GRADE
 HINGES. TWO POINT ROD LOCKING
 DOOR HANDLES. (5) S/S ADJUSTABLE
 SHELVES ON 1/2" INCREMENTS.

Wall Anchored
OPA - 2250-07
Contractor Installed

② **Plan**
 1/2" = 1'-0"

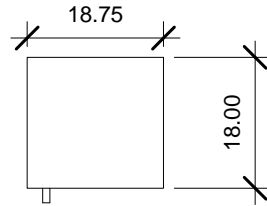

① **Front**
 1/2" = 1'-0"

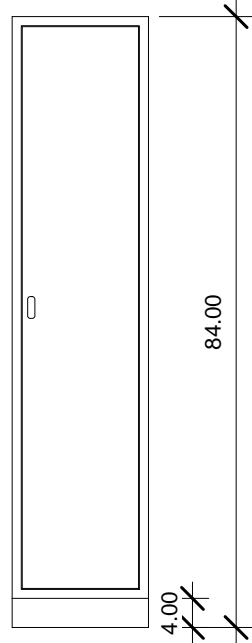

③ **Right**
 1/2" = 1'-0"

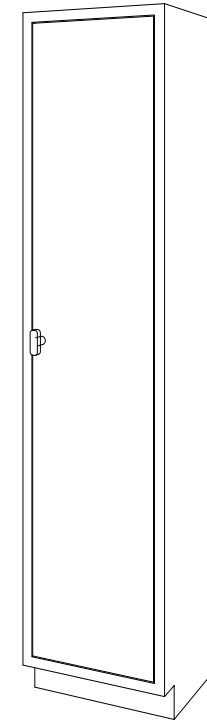
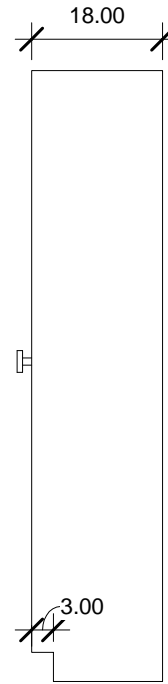

④ **3D View 1**

PO#: _____ DATE: _____
 APPROVAL: _____
 TITLE: _____



	NAME	DATE
DRAWN	JG	2-11-11
ENG APPR.		
MATERIAL		
304 S/S		
FINISH		
POL # 4		
APPRX WEIGHT = lbs 230 SHIPPING		
DO NOT SCALE DRAWING		

BLICKMAN HEALTH INDUSTRIES, INC. LODI, N.J.		
TITLE: H18HAS SOLID HINGED DOOR HIGH CABINET		
SIZE	DWG. NO.	REV
A	2030418000	
SCALE: 1:16		SHEET 1 OF 1

PROPRIETARY AND CONFIDENTIAL
 THE INFORMATION CONTAINED IN THIS
 DRAWING IS THE SOLE PROPERTY OF
 BLICKMAN HEALTH INDUSTRIES. ANY
 REPRODUCTION IN PART OR AS A WHOLE
 WITHOUT THE WRITTEN PERMISSION OF
 BLICKMAN HEALTH INDUSTRIES IS PROHIBITED.

UNLESS OTHERWISE SPECIFIED:
 DIMENSIONS ARE IN INCHES
 BEND RADIUS = MTL THK.
 TOLERANCES:
 FRACTION: ± 1/32"
 DECIMAL: ± .031"

ALL 304 S/S CONSTRUCTION.
 ALL WELDS ARE GROUND AND
 POLISHED TO A # 4 FINISH. BASES
 EQUIPPED WITH LEVELERS. (3) S/S
 FIVE KNUCKLE HOSPITAL GRADE
 HINGES. TWO POINT ROD LOCKING
 DOOR HANDLES. (5) S/S ADJUSTABLE
 SHELVES ON 1/2" INCREMENTS.

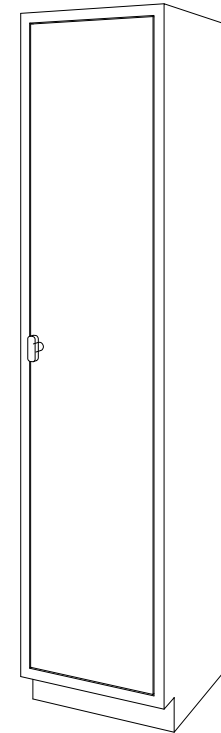
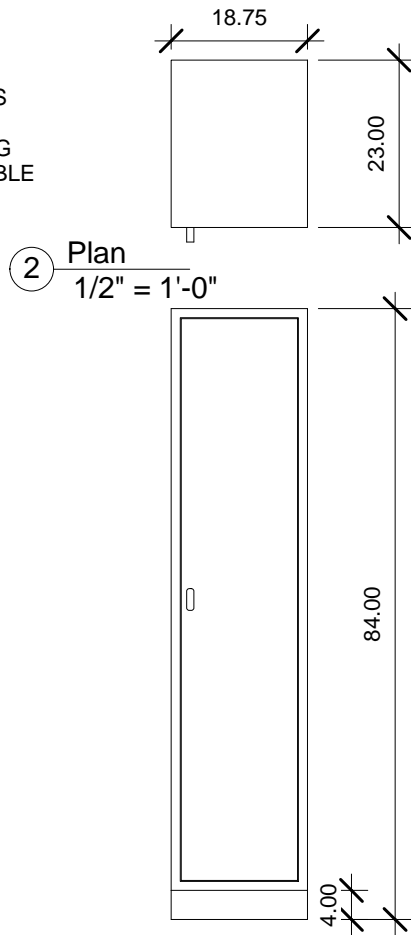

④ 3D View 1

PO#: _____ DATE: _____

APPROVAL: _____

TITLE: _____

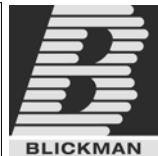

NAME	DATE
JG	2-11-11
ENG APPR.	
MATERIAL	304 S/S
FINISH	POL # 4
APPRX WEIGHT = lbs	250 SHIPPING
DO NOT SCALE DRAWING	

BLICKMAN HEALTH INDUSTRIES, INC. LODI, N.J.		
TITLE: H18HBS SOLID HINGED DOOR HIGH CABINET		
SIZE A	DWG. NO. 2030418230	REV
SCALE: 1:16		SHEET 1 OF 1

PROPRIETARY AND CONFIDENTIAL
 THE INFORMATION CONTAINED IN THIS
 DRAWING IS THE SOLE PROPERTY OF
 BLICKMAN HEALTH INDUSTRIES. ANY
 REPRODUCTION IN PART OR AS A WHOLE
 WITHOUT THE WRITTEN PERMISSION OF
 BLICKMAN HEALTH INDUSTRIES IS PROHIBITED.

UNLESS OTHERWISE SPECIFIED:
 DIMENSIONS ARE IN INCHES
 BEND RADIUS = MTL THK.
 TOLERANCES:
 FRACTION: ± 1/32"
 DECIMAL: ± .031"

ALL 304 S/S CONSTRUCTION.
 ALL WELDS ARE GROUND AND
 POLISHED TO A # 4 FINISH. BASES
 EQUIPPED WITH LEVELERS. (3) S/S
 FIVE KNUCKLE HOSPITAL GRADE
 HINGES. TWO POINT ROD LOCKING
 DOOR HANDLES. (5) S/S ADJUSTABLE
 SHELVES ON 1/2" INCREMENTS.

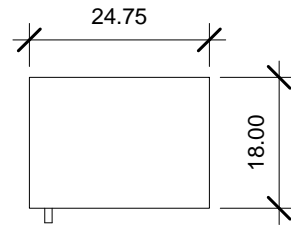

② Plan
 1/2" = 1'-0"

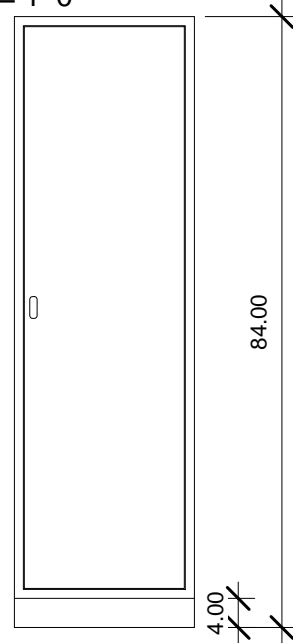

① Front
 1/2" = 1'-0"

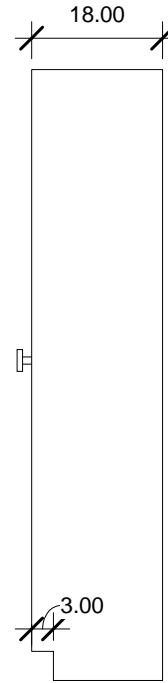

③ Right
 1/2" = 1'-0"

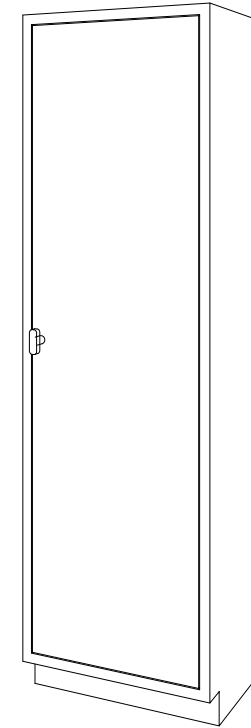

④ 3D View 1

PO#: _____ DATE: _____
 APPROVAL: _____
 TITLE: _____

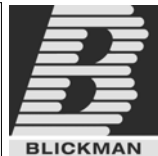

NAME	DATE
JG	2-11-11
ENG APPR.	

MATERIAL
 304 S/S

FINISH
 POL # 4

APPRX WEIGHT = lbs 255 SHIPPING

DO NOT SCALE DRAWING

BLICKMAN HEALTH INDUSTRIES, INC.
 LODI, N.J.

TITLE:
 H24HAS
 SOLID HINGED DOOR
 HIGH CABINET

SIZE A	DWG. NO. 2030424000	REV
------------------	------------------------	-----

SCALE: 1:16 SHEET 1 OF 1

PROPRIETARY AND CONFIDENTIAL
 THE INFORMATION CONTAINED IN THIS
 DRAWING IS THE SOLE PROPERTY OF
 BLICKMAN HEALTH INDUSTRIES. ANY
 REPRODUCTION IN PART OR AS A WHOLE
 WITHOUT THE WRITTEN PERMISSION OF
 BLICKMAN HEALTH INDUSTRIES IS PROHIBITED.

UNLESS OTHERWISE SPECIFIED:
 DIMENSIONS ARE IN INCHES
 BEND RADIUS = MTL THK.
 TOLERANCES:
 FRACTION: ± 1/32"
 DECIMAL: ± .031"

