

MODEL C40-5

5 CUBIC FOOT ULTRA LOW TEMPERATURE FREEZER

	WIDTH	DEPTH	HEIGHT	WIDTH	DEPTH	HEIGHT
INTERIOR DIMENSIONS	30 IN	18 IN	16 IN	76 CM	45 CM	40 CM
EXTERIOR DIMENSIONS	40.5 IN	31 IN	43.75 IN	102 CM	81 CM	111 CM
CRATED DIMENSIONS	46 IN	41 IN	55 IN	116 CM	104 CM	139 CM

NOTE THAT THE FREEZER LID CAN OPEN UP TO APPROXIMATELY 75° FROM HORIZONTAL POSITION

SIDE VIEW

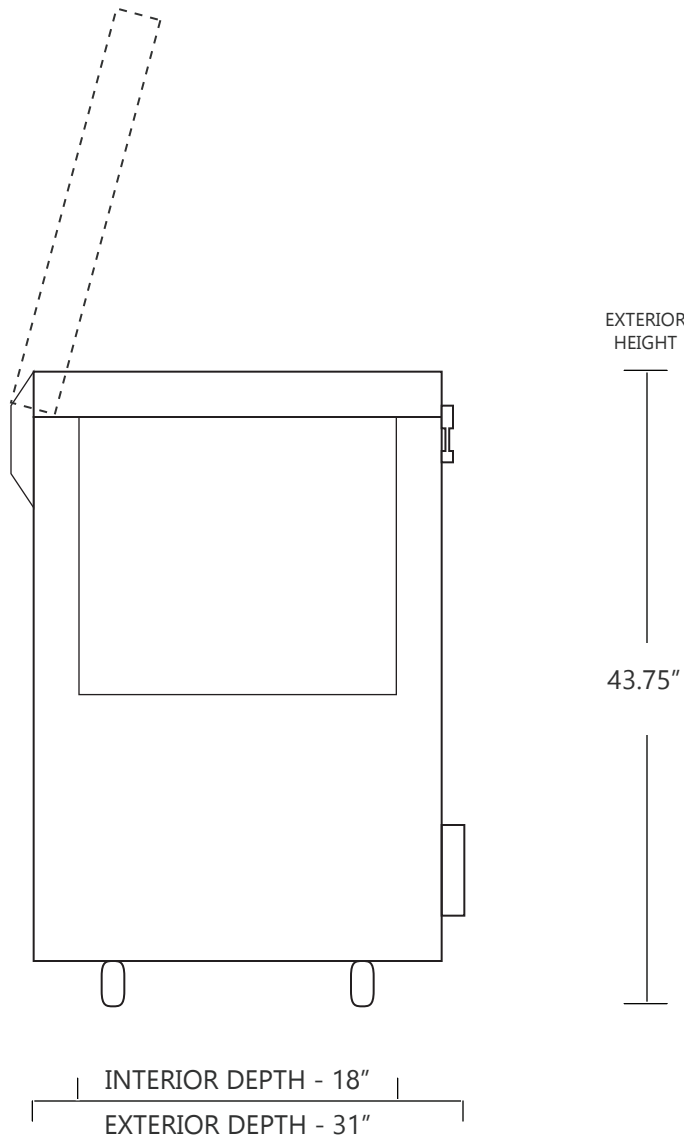

FRONT VIEW

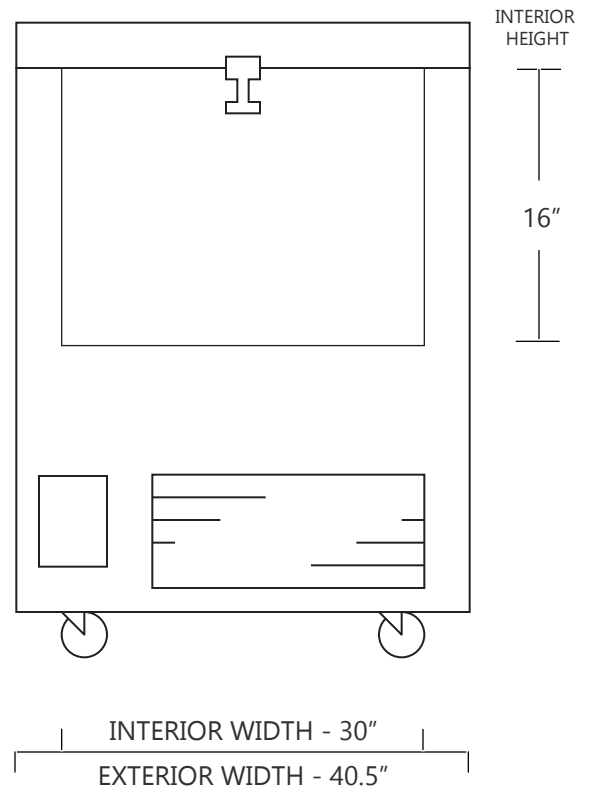

SO-LOW



NET WEIGHT : 425 LBS.
SHIPPING WEIGHT: 525 LBS.

SHIPPING OPTIONS

DOCK-TO-DOCK DELIVERY (REQUIRES FORKLIFT OR PALLET JACK)
 DOCK-TO-DOCK DELIVERY WITH LIFTGATE (REQUIRES FORKLIFT OR PALLET JACK)
 INSIDE DELIVERY (WHITE GLOVE DELIVERY)