





ULTRA LOW FREEZER

U40 / C40 / PH40 / PV40 SERIES

INSTRUCTIONS

USER MANUAL

WARNING: READ BEFORE CONTINUING	
To reduce the risk of fire, electric shock or injury to persons using this freezer, read all instructions and follow basic safety precautions before using the unit, including the following:	
	Do not modify the plug provided with the freezer. If it will not fit the outlet, have a proper outlet installed by a qualified electrician.
	Do not position equipment so it is difficult to disconnect from the power supply. freezer must be at least 6" away from any wall or object on any side.
	While under warranty, do not attempt to repair or replace any part of the freezer for servicing without first contacting the So-Low Service Department.
SAVE THESE INSTRUCTIONS	

For customer service:
Email: sales@so-low.com

For parts replacement:
Email: parts@so-low.com

For technical support:
Email: service@so-low.com

CONTENTS

◆ SYMBOLS AND STARTING INSTRUCTIONS.....	1
• MEANING OF ILLUSTRATED SYMBOLS.....	1
• STARTING INSTRUCTIONS.....	1
◆ UNIT REQUIREMENTS.....	2
• PRE-INSTALLATION INFORMATION.....	2
◆ PREVENTATIVE MAINTENANCE.....	3
• FREEZER STORAGE PROCEDURE.....	3
• ALARM BATTERY REPLACEMENT.....	4
• CLEANING PROCEDURE.....	5
• DEFROSTING PROCEDURE.....	5
• CLEANING AIR CONDENSER.....	6
◆ UNIT OPERATION.....	7
• CHANGING SETPOINT / OPERATION TEMPERATURE.....	7
◆ ALARM OPERATION.....	8
• ALARM SYSTEM.....	8
• DRY CONTACT RELAY.....	8
◆ CONTROL PROGRAMMING.....	9
• CONTROL KEYS & DISPLAYS.....	9
• PROGRAM MENU NAVIGATION.....	10
• CALIBRATION PROCEDURE.....	11
• ALARM DIFFERENTIAL.....	12
• CONTROL HYSTERESIS.....	13
• POWER STATUS ALARM INDICATOR.....	13
◆ FREQUENTLY ASKED QUESTIONS.....	14
◆ REPLACEMENT PARTS LIST.....	15
◆ TECHNICAL SUPPORT.....	16
◆ MAINTENANCE CHECKLIST.....	17
◆ DIAGRAMS.....	18

SYMBOLS AND STARTING INSTRUCTIONS

Explanation

MEANING OF ILLUSTRATED SYMBOLS

ILLUSTRATED SYMBOLS

Various symbols are used in this safety manual in order to use the unit without danger of injury and damage of the unit. Be sure that you understand the warnings and cautions in this manual before operating the unit.



CAUTION

BLACK WITH YELLOW BACKGROUND
LIGHTNING BOLT
CAUTION, RISK OF ELECTRICAL SHOCK



WARNING

BLACK WITH YELLOW BACKGROUND
EXCLAMATION POINT
CAUTION, REFER TO ACCOMPANYING DOCUMENTS

STARTING INSTRUCTIONS

1. Move the freezer to an indoor location, and plug the freezer into an appropriate outlet with an adequate power supply. Consult your maintenance department for additional information on the proper electrical configuration for this unit.
2. Once plugged in, the compressor(s) will start to operate and pull down to the setpoint on the temperature control. The freezers default setpoint is **-85°C** for cascade units, and **-40°C** for single stage units.
3. Allow the freezer to reach the setpoint temperature. Depending on the size of the unit, this may take up to 12 hours.
4. Product can now be loaded into the freezer for storage.



To prevent overloading the cooling system, product should be loaded gradually, in batches. Allow the temperature to recover to setpoint before the next batch of product is loaded into the unit.

Unit Information

PRE-INSTALLATION INFORMATION

RANGE OF ENVIRONMENTAL CONDITIONS FOR WHICH THIS EQUIPMENT IS DESIGNED

1. Indoor use.
2. Altitude up to 2000m.
3. Ambient temperatures 15°C to 30°C (60°F TO 85°F)
4. Recommended humidity range of 30% to 90%.
5. Mains supply fluctuations up to -5% to +10% of the nominal voltage.
6. Transient over-voltages typically present on the mains supply (overvoltage category II). Pollution degree 1.



WARNING

DURING OPERATION THIS UNIT MUST REMAIN IN UPRIGHT POSITION. DURING TRANSPORTATION UNIT MUST NOT BE TIPPED MORE THAN 45° FROM UPRIGHT POSITION.



CAUTION

UNPLUG UNIT AND SWITCH OFF ELECTRICAL BREAKER BEFORE ANY TECHNICAL SERVICE IS PERFORMED.



CAUTION

COVERS ON BACK / SIDE OF FREEZER MAY ONLY BE REMOVED BY AUTHORIZED PERSONNEL. FAILURE TO RE-INSTALL COVER COULD RESULT IN HAZARD.



CAUTION

UNIT MUST BE OPERATED ON A DEDICATED ELECTRICAL LINE. USING A NON-DEDICATED LINE MAY RESULT IN UNIT STARTUP FAILURE.



CAUTION

ONLY PLUG THIS UNIT INTO THE PROPER OUTLET. DO NOT ATTEMPT TO MODIFY PLUG IN ANY WAY. IMPROPER USE OF THE ELECTRICAL PLUG WILL VOID WARRANTY.



WARNING

DO NOT POSITION EQUIPMENT SO IT IS DIFFICULT TO DISCONNECT FROM THE POWER SUPPLY.

FREEZER STORAGE PROCEDURE

The unit can be turned off for storage by unplugging the unit from the wall outlet and/or switching off the electrical breaker in the electrical box.



ATTENTION

RISK OF ELECTRICAL SHOCK
USE CAUTION NEAR ELECTRICAL CONNECTIONS

Once the unit is unplugged, the freezer will go into “Power Failure” alarm. To disable the Power Failure alarm;

1. Locate the electrical panel on the side of the freezer.
2. Remove the screws with a Phillips screwdriver, and remove the panel.
3. Locate the battery (which is clearly marked) in the lower right hand corner.
4. Disconnect one lead from the battery by removing the connector on the battery.

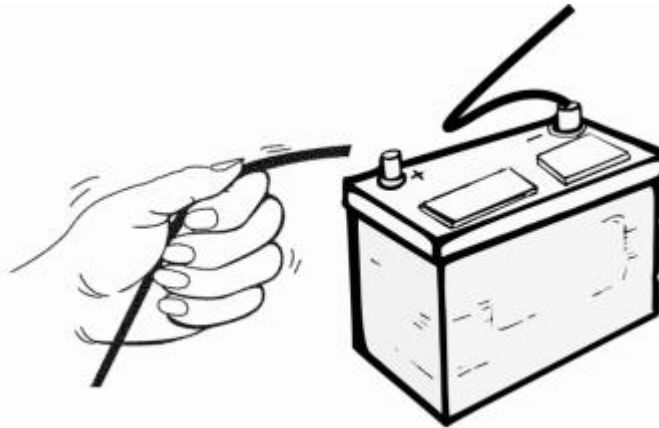

5. When returning the unit to service, complete steps 1-4, but reconnect the unplugged battery in step 4. Then plug the unit into the outlet to restore power.



NOTICE

SEE STARTING INSTRUCTIONS ON PAGE 1 WHEN
PUTTING UNIT BACK INTO SERVICE.

ALARM BATTERY REPLACEMENT



NOTICE

TO REDUCE THE RISK OF FIRE, ELECTRIC SHOCK OR INJURY TO PERSONS USING THIS FREEZER, READ ALL INSTRUCTIONS AND FOLLOW BASIC SAFETY PRECAUTIONS.



CAUTION

DISCONNECT THIS UNIT FROM THE POWER SUPPLY BEFORE PERFORMING MAINTENANCE ON THE UNIT.

1. Unplug freezer from power supply.
2. Remove cover marked electrical panel located on side of cabinet.
3. Disconnect wires from battery terminals – Note which color wires were connected to positive/negative. Colors vary depending on when unit was made. Older models used black wire as positive and white as negative. Newer models use red wire as positive and black as negative. See picture for battery location.
4. Remove strap holding battery in place.
5. Replace battery and reconnect wires (see #3)
6. Test alarm.
7. Reinstall battery strap and electrical box cover.
8. Plug freezer back into power supply, and allow up to 24 hours for the new battery to fully charge.



CLEANING PROCEDURE

Wipe down the exterior of the freezer with a soft cloth and/or general spray type polish. Do not use corrosive cleaners/chemicals on the exterior.

If frost builds up in the chamber, a bucket and ice-scraper can be used to remove ice. If excessive ice builds up, the unit can be defrosted (see below).

DEFROST PROCEDURE

1. Remove any product in the freezer, and temporarily store it in a back-up freezer or elsewhere.
2. Unplug the freezer, and fully open the freezer front door / lid.



ATTENTION

FOR UPRIGHT UNITS, IT IS IMPORTANT TO PROTECT THE CONTROL FROM DRIPPING WATER. PLACE A CLOTH OR TOWEL ON THE LEADING EDGE OF THE COOLING CHAMBER ABOVE THE CONTROL TO DEFLECT / ABSORB WATER THAT COULD DRAIN ONTO THE CONTROL.

3. Air out the freezer, allowing the unit to reach room temperature for at least 12 hours. Using fans to blow air into the unit is recommended.
4. Take a rag and wipe up all the excess water in the unit (melted frost).
5. Close the unit, and plug the unit in to activate the start-up process.

PLEASE CONSULT THE START-UP INSTRUCTIONS ON PAGE 1 FOR UNIT STARTUP

6. Once the desired temperature is reached, you may slowly begin to add your product back into the unit.
-
-



ATTENTION

IT IS RECOMMENDED TO SLOWLY RE-ADD YOUR PRODUCT INTO THE FREEZER TO PREVENT AN EXTREME LOAD ON THE COMPRESSORS, WHICH COULD SHORTEN FREEZER LIFE EXPECTANCY.

CLEANING AIR CONDENSER

Large amounts of dust build-up on the air-cooled condenser can cause excess stress for the refrigeration system. This excess stress may increase the chance of a refrigeration issue and reduce the life expectancy of the refrigeration system.



ATTENTION

IT IS RECOMMENDED TO CLEAN THE CONDENSER AT LEAST ONCE EVERY 90 DAYS TO PREVENT DUST BUILDUP.

1. Using a Philips Head screwdriver, remove the screws for grill located on front of unit. Once the screws are removed, the front grill can be removed allowing easy access to the air cooled condenser.

Note: It is recommended to keep the screws in a safe location, so they can be used to re-attach the grill once cleaning is completed.

2. Use a vacuum cleaner to pull up any dust built up on the condenser fins. The most efficient method of doing this is using a furniture cleaning attachment (if available).

Note: Cans of compressed air can also be used to blow away dust, however this is not the most recommended way to clean the condenser; as the dust may float through the air and eventually return to clog the condenser.

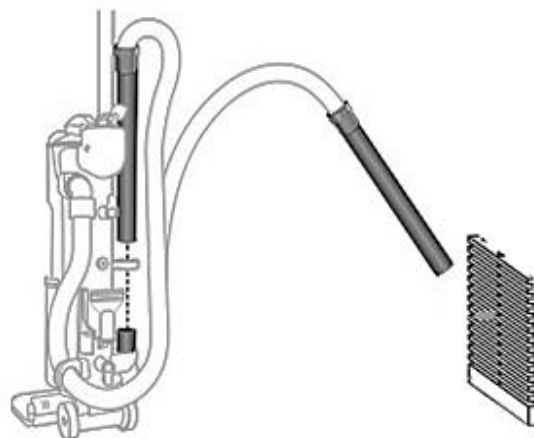

3. Once clean, re-align the front grill and attach it using a screwdriver.

CHANGING SETPOINT TEMPERATURE

The temperature control is manually adjustable to the desired temperature in 1° C increments within the limits of the control range.



TEMPERATURE SET POINT

The control has two displays;

- 1) The upper display (**PV**) is the current actual unit temperature.
- 2) The lower display (**SV**) is the temperature set point.

The temperature set point has been pre-set at the factory. See page 1 for additional information on factory default setpoint.

CHANGING TEMPERATURE SETPOINT

The temperature set point can be changed by press and **HOLD** the  arrow to raise or the  arrow to lower the temperature set point.



WARNING

CHANGING THE CONTROL PARAMETERS OUTSIDE OF THE MANUFACTURE RECOMMENDED RANGE, COULD CAUSE ISSUES RESULTING IN MECHANICAL FAILURE, AND VOID THE WARRANTY FOR THE UNIT.



CAUTION

THE CONTROLLER IS DESIGNED FOR INDOOR USE ONLY AND IS NOT INTENDED FOR USE IN HAZARDOUS AREAS.

IT SHOULD BE LOCATED/INSTALLED IN SUCH A MANNER AS TO MINIMIZE EFFECTS OF SHOCK, VIBRATION, AND ELECTROMAGNETIC FIELDS, MOTORS, AND TRANSFORMERS.



CAUTION

BEFORE PERFORMING INSTALLATION OR TROUBLESHOOTING PROCEDURES, THE POWER TO THE EQUIPMENT MUST BE DISCONNECTED.

TO MINIMIZE THE POSSIBILITY OF FIRE OR ELECTRICAL SHOCK HAZARDS, DO NOT EXPOSE THIS INSTRUMENT TO RAIN OR EXCESSIVE MOISTURE.

ALARM / RELAY OPERATION

ALARM SYSTEM

When operating the unit for the first time, the alarm will be disabled until the unit reaches set point, or 8 hours after the unit has been first plugged in. The alarm will not sound again until the unit goes out of temperature range.

THE FACTORY DEFAULT ALARM RANGE IS $\pm 12^{\circ}\text{C}$ (20°F) FROM SETPOINT.

Note: The freezer contains a back-up battery, which will power the alarm system for approximately 48 hours during a power outage.

ALARM SYSTEM BATTERY REPLACEMENT

- Rechargeable batteries should be changed approximately every three years with lead acid rechargeable 1.2 Ah minimum, Battery replacement model number **PS-1250** or equivalent is factory recommended.



ATTENTION

THE BATTERY DOES NOT POWER THE COOLING SYSTEM.

DRY CONTACT RELAY

The dry contact relay is a terminal strip located on the back of the freezer.

RATING OF THIS CONNECTION:

2A 125 VAC

2A 30 VDC

RED – NORMALLY CLOSED
WHITE – COMMON
BLUE – NORMALLY OPEN





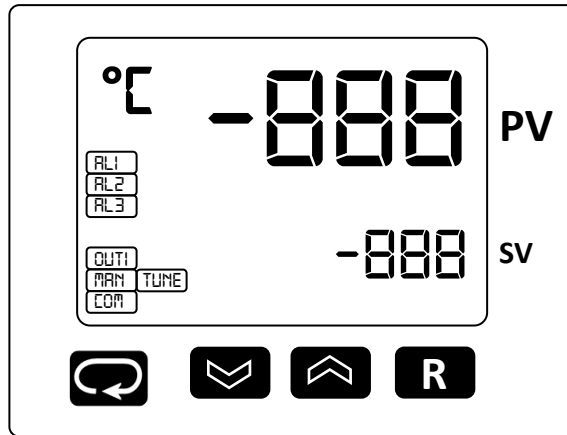

WARNING

IF IT IS NECESSARY TO REMOVE METAL COVER SCREEN ON BACK OF FREEZER TO MAKE CONNECTIONS TO ALARM RELAY, COVER MUST BE REPLACED BEFORE FREEZER IS PUT INTO OPERATION

CONTROL KEYS & DISPLAYS



The FDC-C42 controller is programmed by using four keys on the front panel. The available function keys are listed in the following table:

TOUCH KEYS	FUNCTION	DESCRIPTION
	Up Key	Press and release to increase the current control set point (while in normal control mode) or to change the value of the selected parameter (while in the Setup Menu).
	Down Key	Press and release to decrease the current control set point (while in normal control mode) or to change the value of the selected parameter (while in the Setup Menu).
	Scroll Key	Press and hold for at least 5 seconds to enter the Setup Menu. The upper display will show SET and then release the key.
	Reset Key	Press and release to return the display to the home screen (while in User Menu or Setup Menu).

During power-up, the upper display will show PROG and the lower display will show the firmware version for 6 seconds.

DISPLAY / ERROR / MODE ICONS	
PV	Actual Temperature
SV	Setpoint Temperature
°C / °F	Temperature Scale Indicator
AL1 AL2 AL3	Alarm Indicator
OUT1	Output Indicator
MAN	Manual Mode Indicator
COM	Communication Indicator
TUNE	Auto Tuning Indicator

PROGRAM MENU NAVIGATION

To enter the PROGRAM parameter mode, hold the **SCROLL** key until the screen changes to 'SET', then release. This will take approximately 5 seconds.



To access menu parameters; Press and Release the **UP** and **DOWN** arrows to adjust the display to the correct menu parameter.



Once the correct menu parameter is selected, press the **SCROLL** button to access the desired sub-menu parameter.



When the desired sub-menu parameter is selected, press the **UP** and **DOWN** arrows to adjust the sub-menu parameter values.



To exit tap **RESET** key until the temperature/setpoint screen appears.



THE FOLLOWING VALUES WERE FACTORY SET WHEN THIS UNIT WAS SHIPPED. INCORRECT MODIFICATION OF THESE VALUES CAN VOID THE WARRANTY OF THE UNIT.







PARAMETER	SUB PARAMETERS	DESCRIPTION	°F	°C
bASE	SP1L	Lower Setpoint	-88	-67
bASE	SP1H	Upper Setpoint	+32	0
bASE	UNIT	Temperature Scale	°F	°C
bASE	OFTL	Calibration		
ALRM	A1DV	Alarm Differential	22	12
ALRM	A1HY	Alarm Hysteresis	0.1	0.1
OUT	O1HY	Output Hysteresis	3.6	2.0

CALIBRATION PROCEDURE

Each unit is calibrated at the factory before shipment. The user can still modify the calibration in the field. The basic calibration of the controller is highly stable and set for life. User calibration allows the user to offset the permanent factory calibration in order to:

- Calibrate the controller to meet a user reference standard.
- Match the calibration of the controller to that of a particular transducer or sensor input.
- Calibrate the controller to suit the characteristics of a particular installation.
- Remove long term drift in the factory set calibration.

TO CALIBRATE THE CONTROLLER FOLLOW THE BELOW STEPS

1		Hold the SCROLL key until the screen changes to SET , then release. This will take approximately 5 seconds.
2		Press and Release the UP and DOWN arrows until the value: bASE is displayed.
3		Press and Release the SCROLL button until the value: OFTL is displayed.
4		Press the UP and DOWN arrows to adjust the calibration value to the desired value.
5		Press and hold the SCROLL button for 5 seconds to complete the calibration process.
6		Press and hold the RESET button to exit out of the programming menu.



CAUTION







INCORRECT MODIFICATION OF THESE VALUES CAN RESULT IN MALFUNCTION OR UNEXPECTED OPERATION OF THE UNIT, AND MAY VOID THE WARRANTY OF THE UNIT.

ALARM DIFFERENTIAL

The alarm type for relay output 2 (AL1) is pre-configured for deviation band. This means that the alarm deviation set point (A1DV) follows the control set point evenly above and below the main control set point. The alarm hysteresis (A1HY) is safe sided.

The alarm relay's output will operate in the following manner. For example, the main control set point is -40° (F or C), the alarm deviation set point (A1DV) is 12° and the alarm hysteresis value (A1HY) is 0.1. The alarm relay's output will be energized when the temperature is outside of the deviation alarm band (below -52° or above -28°). The alarm relay will de-energize when the temperature falls within the hysteresis band (between -51.9° and -28.1°). When the alarm relay's output is energized, the alarm output status indicator (labeled AL1 on the front panel) will be illuminated.





To change the alarm set point and hysteresis values, enter the Setup menu and access the alarm parameters as follows:

1		Hold the SCROLL key until the screen changes to SET , then release. This will take approximately 5 seconds.
2		Press and Release the UP and DOWN arrows until the value: OUT is displayed.
3		Press and Release the SCROLL button until the value: A1HY is displayed.
4		Press the UP and DOWN arrows to adjust the value to the desired value.
5		Press and Release the SCROLL button until the value: A1DV is displayed.
6		Press the UP and DOWN arrows to adjust the value to the desired value.
7		Press and hold the RESET button to exit out of the programming menu.

CONTROL HYSTERESIS

The control type for relay output 1 is pre-configured for cooling (direct action). The control hysteresis (prompt O1HY) is safe-sided. The control relay's output will operate in the following manner. For example, the set point is -40° (F or C), and the control hysteresis value is 2.0. The control relay's output will be energized until the temperature reached -42° and then de-energize. When the temperature rises to -40° or above, the control relay's output is energized. When the control relay's output is energized, the control output status indicator (labeled OUT1 on the front panel) will be illuminated.

To change the control hysteresis, enter the Setup menu and access the output parameters as follows:

1		Hold the SCROLL key until the screen changes to SET , then release. This will take approximately 5 seconds.
2		Press and Release the UP and DOWN arrows until the value: ALRM is displayed.
3		Press and Release the SCROLL button until the value: O1HY is displayed.
4		Press the UP and DOWN arrows to adjust the value to the desired value.
5		Press and hold the RESET button to exit out of the programming menu.

POWER STATUS ALARM INDICATORS

The FDC-C42 events inputs 1 and 2 and alarm outputs 2 and 3 are pre-configured to act as power supply status alarms. Event input 1 and alarm output 2 (AL2) are utilized to indicate a power failure. Under normal operation, event input 1 will be activated indicating power is present. When main power is lost, event input 1 will deactivate, and in turn cause alarm 2 relay output to energize. When the alarm relay's output is energized, the alarm output status indicator (labeled AL2 on the front panel) will be illuminated.

Event input 2 and alarm output 2 (AL3) are utilized to indicate low battery. Under normal operation, event input 2 will be deactivated. When the battery is low, event input 2 will be activated and in turn cause alarm 3 relay output to energize. When the alarm relay's output is energized, the alarm output status indicator (labeled AL3 on the front panel) will be illuminated.

COMMON QUESTIONS

Q: When should I defrost my unit?

A: Units should be defrosted when ice accumulation reaches approximately 1/2 inch thick. Ice acts like an insulator and has to work harder to reach the same temperature.

Q: Is this unit self-defrosting?

A: No, this unit is a manual defrost unit.

Q: Should I leave my freezer operating when I am not using it?

A: This unit is designed to operate continuously. Leaving the refrigeration system in operation, (even if not in use) may extend the life of the freezer, and reduce the chance of refrigeration issues that may occur if the freezer is not in operation for long periods of time.

Q: What ambient conditions is this unit designed for?

A: This unit is designed for:

- Indoor use
- Altitude up to 2000m.
- Temperatures 15°C to 32°C (60°F TO 85°F)
- Recommended humidity range of 30% to 90%.

Q: What electrical conditions is this unit designed for?

A: This unit is designed for:

- Mains supply fluctuations up to -5% to +10% of the nominal voltage. Consult the serial tag for nominal voltage.
- Transient overvoltage typically present on the mains supply (overvoltage category II). Pollution degree 1.

Q: Does my unit require a dedicated electrical line?

A: Yes, this unit requires a dedicated electrical line.

Please consult the labels on your unit for specific electrical requirements.

Q: Will the backup battery keep my unit cool during power failure?

A: NO, the backup battery only powers the alarm during power failure. It will not power the refrigeration system, and will not keep the unit cooling during power outages.

Q: Will the freezer start up after a power outage?

A: Yes, the freezer will automatically re-start when power is restored.

The overall restart process will begin in stages to prevent system overloads; and may take up to minutes after re-start before cooling resumes.

REPLACEMENT PARTS LIST

COMPRESSOR MODEL	HP	VOLTAGE	HERTZ	PHASE	PART #
TECUMSEH AJB2433ZXA	1	115	50/60	1	AJB24-115
TECUMSEH AJB2433ZXD	1	208/220/230	50/60	1	AJB24-208
EMBRACO FFI12HBX	1/3	115	50/60	1	FF12-115
DANFOSS SC15FTX	1/3	115	50/60	1	SC15-115
DANFOSS SC18FTX	1/2	208/220/230	50/60	1	SC15-208

TEMPERATURE CONTROL PARTS	PART #
FDC C42	FDC-C42-VOLTAGE
FDC nCOMPASS	nCOMPASS

ELECTRICAL PARTS	PART #
Heater Harness No. H-200	217-VOLTAGE
Refrigeration Switch No. 2X464	TOGGLE
Condenser Fan Motor No. GE-5411 - 115/60/1	500-115
Condenser Fan Motor No. GE-5421 - 230/50-60/1	500-VOLTAGE
Electrical Cord No. 8-3 (Please Specify Voltage)	PWRCRD-VOLTAGE
Control Board No. CECB2TUV (Please Specify Voltage)	231-VOLTAGE

REFRIGERATION HIGH STAGE PARTS	PART #
Air Cooled Condenser No. 3CZ0602B	254
Drier No. C-053-S	256H
Capillary Tube	HS-17, HS-20
Oil Separator, Temprite Series 900 (If Applicable)	900

REFRIGERATION LOW STAGE PARTS	PART #
Pressure Control No. 20PS01-0039	259
Receiver Condenser	RCN-LS
Drier No. CO-52S-S	256L
Capillary Tube	LS-28, LS-31
Oil Separator, Temprite Series 900 (If Applicable)	900

HARDWARE PARTS	PART #
Latch No. METL-L1-99	REX37L1-3
Chest Hinge	59-928M
Upright Hinge No. Polar 109-LH	59-928U
Cabinet Gasket	NX504B1
Lid or Door Gasket	PSOS
Grill No. 650H	356F, 356S
Sub-Lids (Must have Model Number)	SL-MODEL NUMBER
Inner Door (Must have Model & Serial Number)	357-MODEL NUMBER-SERIAL NUMBER
Clips & Rollers for Inner Doors (Quantity 10 minimum)	405
Shelves for Freezer (Must have Model Number)	4015-MODEL NUMBER

TECHNICAL ASSISTANCE

IN CASE OF REQUEST FOR REPAIR

If failure occurs, stop operation of unit, and turn OFF the breaker power switch located in the electrical panel box, and unplug the power plug.



WARNING

IF FAILURE OCCURS AND UNIT IS STILL UNDER WARRANTY, DO NOT ATTEMPT TO MAKE ANY REPAIR MODIFICATIONS TO THE UNIT BEFORE CONTACTING THE SO-LOW SERVICE DEPARTMENT, AS THIS MAY RESULT IN WARRANTY BEING VOIDED.

< CHECK FOLLOWING ITEMS BEFORE CALLING OR EMAILING >

◆ Model Number of Product

◆ Serial Number of Product

◆ Issue (as detailed as possible)

For customer service:
Email: sales@so-low.com

For parts replacement:
Email: parts@so-low.com

For technical support:
Email: service@so-low.com

MAINTENANCE CHECKLIST

IT IS RECOMMENDED TO COMPLETE CHECKLIST EVERY 30 DAYS

◆ MODEL NUMBER OF PRODUCT

◆ SERIAL NUMBER OF PRODUCT

Checked that freezer is operating at the correct setpoint temperature.

Checked operation of condenser fans, and cleaned air cooled condenser.

Confirmed unit is at least 6 inches away from walls, or obstacles, on all sides to allow for sufficient air flow.

Confirmed ambient room temperature is within range acceptable ranges.
Recommended room temperature range is 15°C to 26°C (60°F TO 80°F)

◆ **AMBIENT ROOM TEMPERATURE IS:** _____°

Checked operation of alarm system on unit.

Note: Alarm can be simulated by temporarily raising setpoint out of range.

Checked temperature recorders for proper operation (If applicable).

Note: If there are any deviations observed, further diagnosing may be required.

Check operation of CO2 or LN2 backup system. (If applicable)

**ITEMS BELOW MUST BE CHECKED BY YOUR IN-HOUSE TECHNICAL PROFESSIONAL
USE CAUTION WHEN WORKING AROUND ELECTRICAL CIRCUITS**

Checked AMP draw of unit when compressors stabilize.

Checked incoming voltage and voltage drop when compressors start up.

◆ NOTES

◆ COMPLETED BY

◆ COMPLETED DATE

115 VOLT ELECTRICAL DIAGRAM

NOTE: DIAGRAM ONLY APPLIES TO 115 VOLTS, AND MAY NOT APPLY TO YOUR SPECIFIC UNIT.

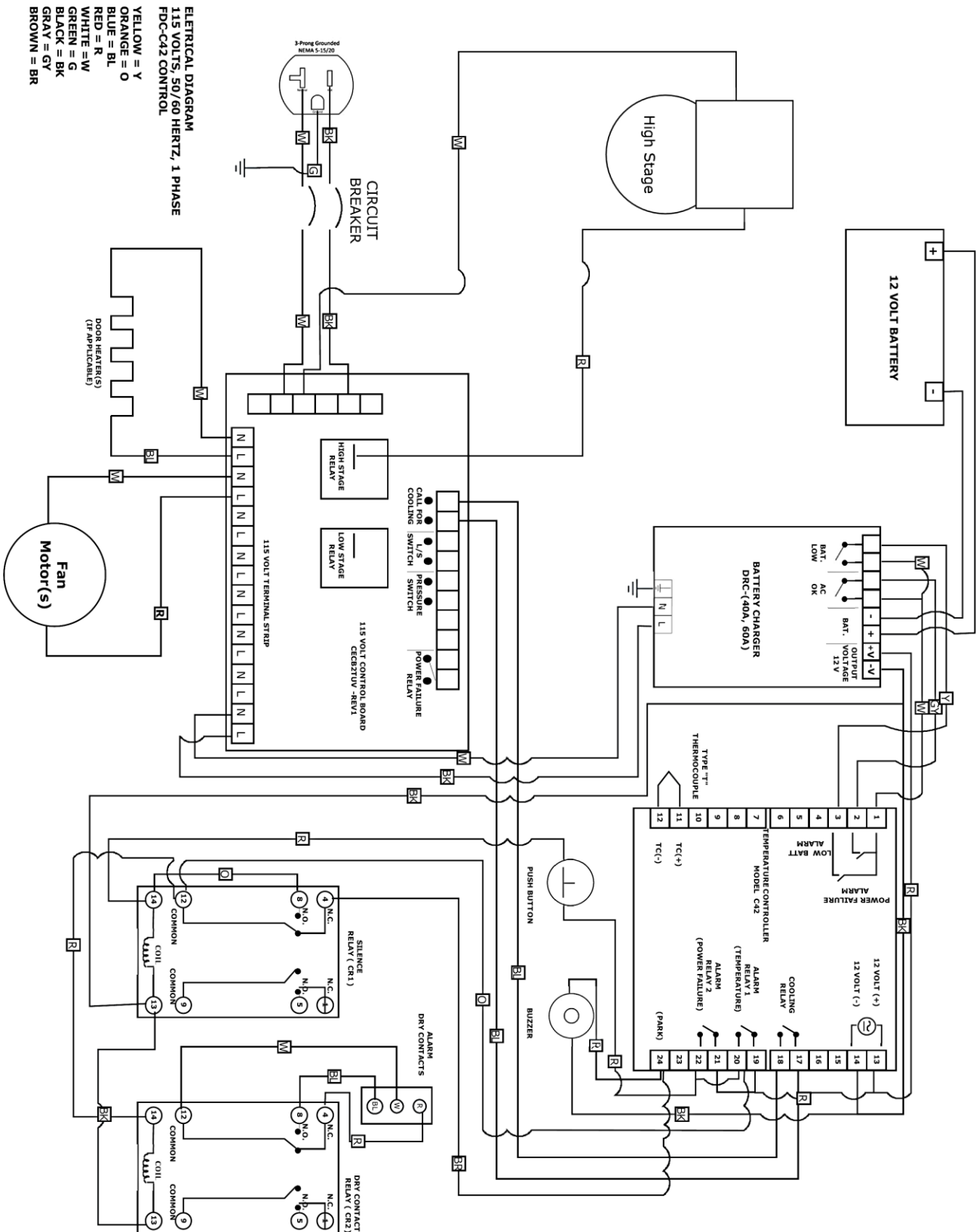

208 / 230 VOLT ELECTRICAL DIAGRAM

NOTE: DIAGRAM ONLY APPLIES TO 208 or 230 VOLTS, AND MAY NOT APPLY TO YOUR SPECIFIC UNIT.

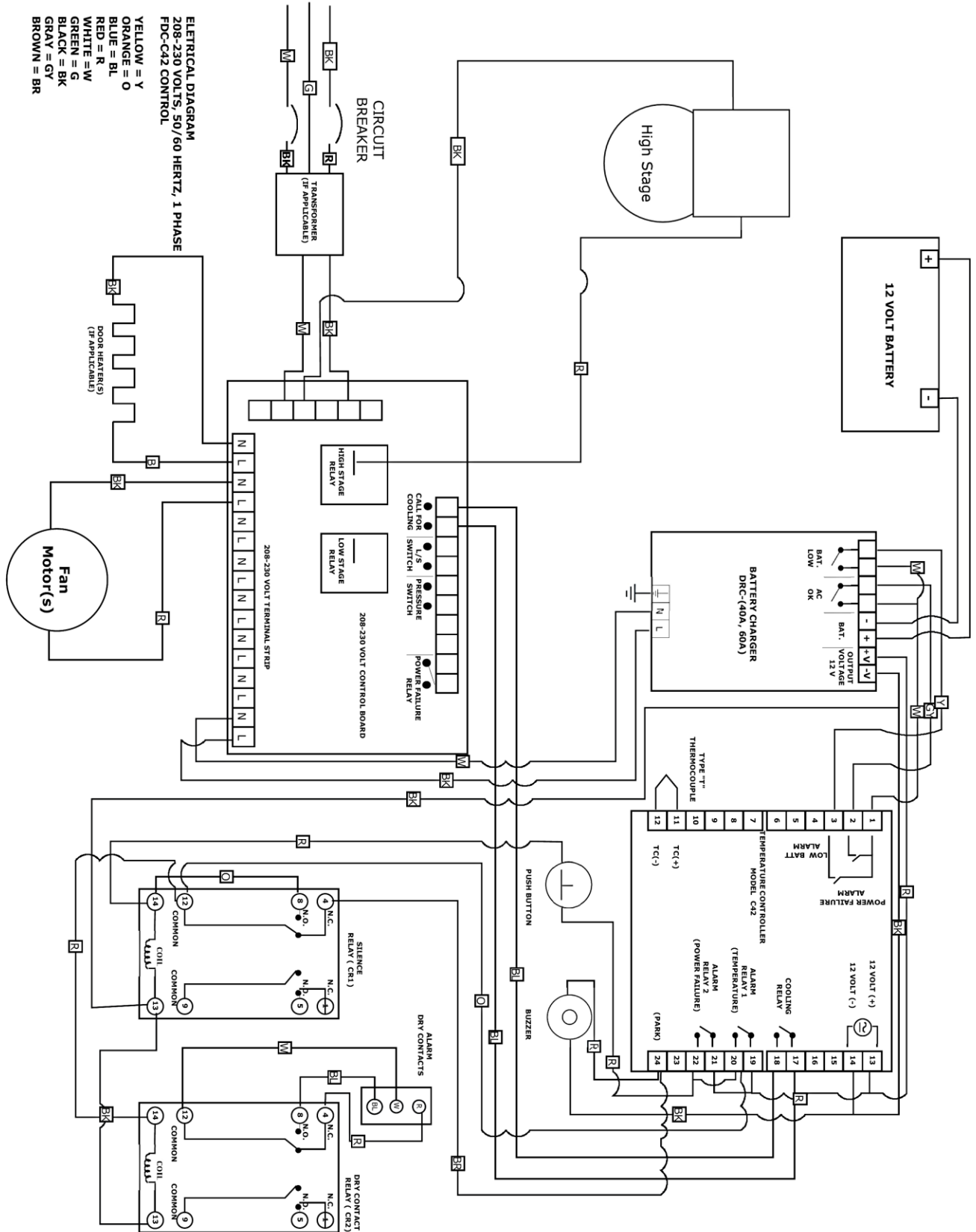

ALARM DIAGRAM

Connection to the alarm relays and audible alarm require external control relays that are not part of the control assembly. One relay is utilized to provide remote contacts for customer connection for remote alarm indication (shown as CR1 in the following diagram) and is optional. The other relay is utilized for the audible alarm silence (shown as CR2 in the following diagram) which is required.

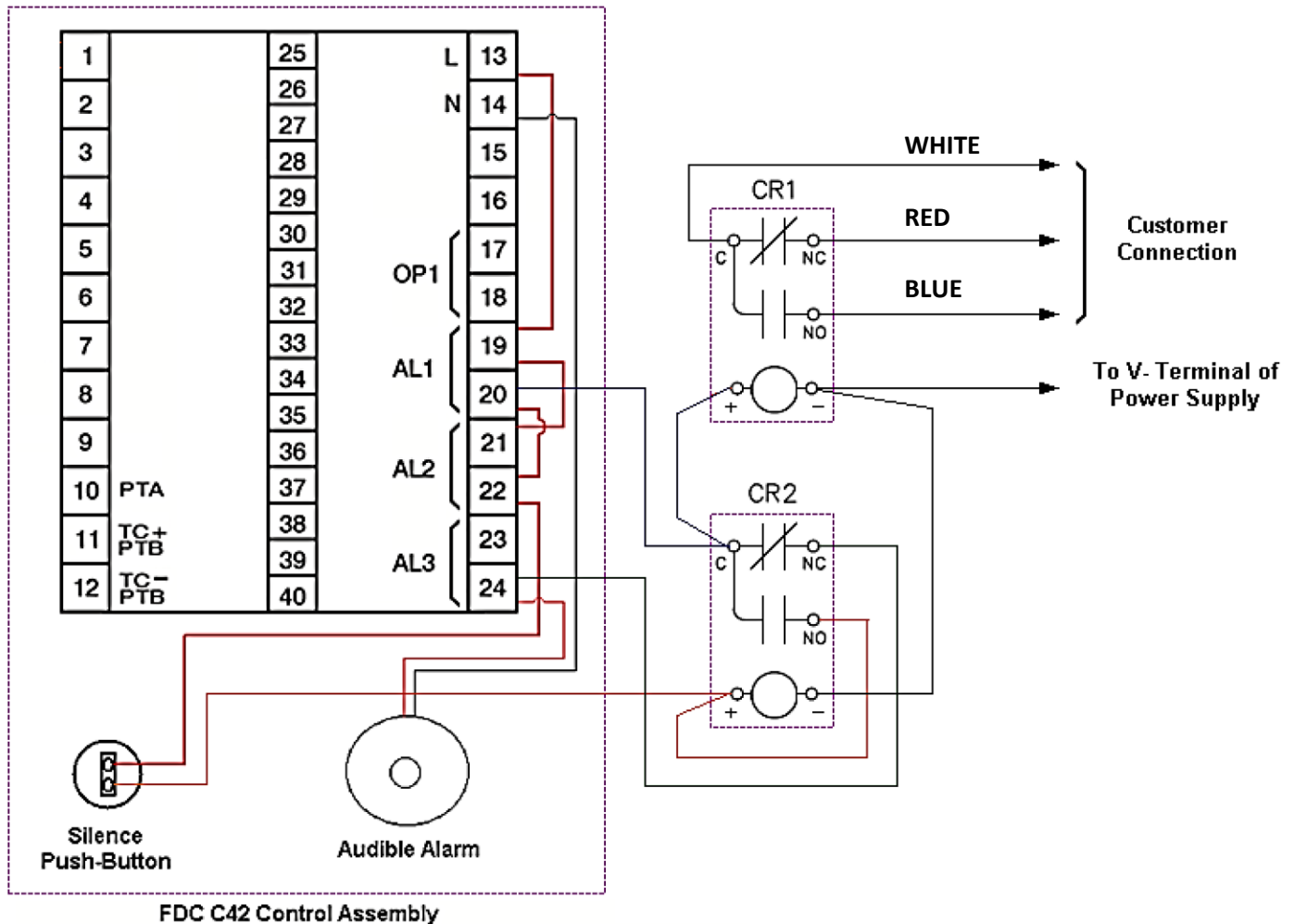

Note that alarm 3 (low battery) is utilized for indication only. When an alarm relay is energized, the corresponding alarm indicator, AL1 for alarm 1 (temperature), AL2 for alarm 2 (power failure) or AL3 for alarm 3 (low battery), will be illuminated on the upper left of the C42 LCD display. When either a high/low temperature or power failure alarm activates, the audible alarm will sound as power from the alarm contact will pass through the normally closed contact of relay CR2. When the silence button is pressed, the coil of relay CR2 will be energized. Since the normally open contact of CR2 will then close, power will pass through the relay contact and will in turn hold the relay coil energized even after the push-button is released.

This will hold the normally closed contact of the relay open, removing power from the audible alarm so that it will no longer sound. Once both alarm conditions are no longer present, both alarm 1 and alarm 2 outputs of the C42 will be de-energized. This will in turn remove power from the coil of relay CR2 causing it to de-energize. This will then ensure that upon the next activation of either the temperature or power failure alarm output, power will again pass to the audible alarm causing it to sound until the alarm condition clears or the operator presses the silence button.

1.3 Specifications

Specification	C22	C62	C82	C83		C42	R22
Power Supply	90 to 250VAC, 47 to 63Hz, 20 to 28 VAC, 47-63Hz / 11 to 40 VDC						
Power Consumption	C22 / R22: 8VA, 4W Maximum., C62: 10VA, 5W Maximum., C82 / C83 / C42: 12VA, 6W Maximum						
Over Voltage Category	II						
Signal Input							
Type	Thermocouple (J, K, T, E, B, R, S, N, L, U, P, C, D), RTD(PT100(DIN), PT100(JIS)), Current(mA), Voltage (V, mV)						
Resolution	18 Bits						
Sampling Rate	5 Times / Second (200msec)						
Maximum Rating	-2VDC minimum, 12VDC maximum						
Input Characteristics	Type	Range		Accuracy @ 25°C		Input Impedance	
	J	-120°C to 1000°C (-184°F to 1832°F)		±2°C		2.2 MΩ	
	K	-200°C to 1370°C (-328°F to 2498°F)		±2°C		2.2 MΩ	
	T	-250°C to 400°C (-418°F to 752°F)		±2°C		2.2 MΩ	
	E	-100°C to 900°C (-148°F to 1652°F)		±2°C		2.2 MΩ	
	B	0°C to 1820°C (32°F to 3308°F)		±2°C (200°C to 1800°C)		2.2 MΩ	
	R	0°C to 1767.8°C (32°F to 3214°F)		±2°C		2.2 MΩ	
	S	0°C to 1767.8°C (32°F to 3214°F)		±2°C		2.2 MΩ	
	N	-250°C to 1300°C (-418°F to 2372°F)		±2°C		2.2 MΩ	
	L	-200°C to 900°C (-328°F to 1652°F)		±2°C		2.2 MΩ	
	U	-200°C to 600°C (-328°F to 1112°F)		±2°C		2.2 MΩ	
	P	0°C to 1395°C (32°F to 2543°F)		±2°C		2.2 MΩ	
	C	0°C to 2300°C (32°F to 4172°F)		±2°C		2.2 MΩ	
	D	0°C to 2300°C (32°F to 4172°F)		±2°C		2.2 MΩ	
	Land Jewel	0°C to 1880°C (32°F to 3416°F) (Not available for C22, C62 & R22)		±2°C		2.2 MΩ	
	PT100(DIN)	-200°C to 850°C (-328°F to 1562°F)		±0.4°C		1.3KΩ	
PT100(JIS)	-200°C to 600°C (-328°F to 1112°F)		±0.4°C		1.3KΩ		
mA	-3mA to 27mA		±0.05%		2.5Ω		
VDC	-1.3VDC to 11.5VDC		±0.05%		1.5MΩ		
mV	0 to 50mV		±0.05%		2.2 MΩ		
Temperature Effect	1.5μV /°C for all inputs except mA input, 3.0μV /°C for mA						
Sensor Lead Resistance Effect	Thermocouple: 0.2 μV /°Ω; 3-wire RTD: 2.6°C /Ω of Difference of Resistance of two leads 2-wire RTD: 2.6°C /Ω of Sum of Resistance of two leads						
Burn-out Current	200nA						
CMRR	120 dB						
NMRR	55dB						
Sensor Break Detection	Sensor open for Thermocouple, RTD and mV inputs, Sensor short for RTD input, Below 1mA for 4-20mA input, Below 0.25VDC for 1 - 5VDC input, Not available for other inputs.						
Sensor Break Response Time	Within 4 seconds for Thermocouple, RTD and mV inputs, 0.1 second for 4-20mA and 1 - 5VDC inputs.						
Remote Set Point Input							
Type	Linear Current, Linear Voltage						
Range	-3mA to 27mA, -1.3VDC to 11.5VDC						
Accuracy	±0.05 %						
Remote Set Point Option	Not Available	Not Available	Available	Available	Available	Available	Not Available
Input Impedance	Current: 2.5Ω, Voltage: 1.5MΩ						
Resolution	18 Bits						
Sampling Rate	1.66 Times/Second						
Maximum Rating	280mA maximum for Current Input, 12VDC Maximum for Voltage Input						
Temperature Effect	±1.5μV/°C for Voltage Input, ±3.0μV/°C for Current Input						
Sensor Break Detection	Below 1mA for 4-20mA input, Below 0.25VDC for 1 - 5VDC input, Not available for other inputs.						
Sensor Break Responding Time	0.1 Second						

REFRIGERATION FLOW DIAGRAM

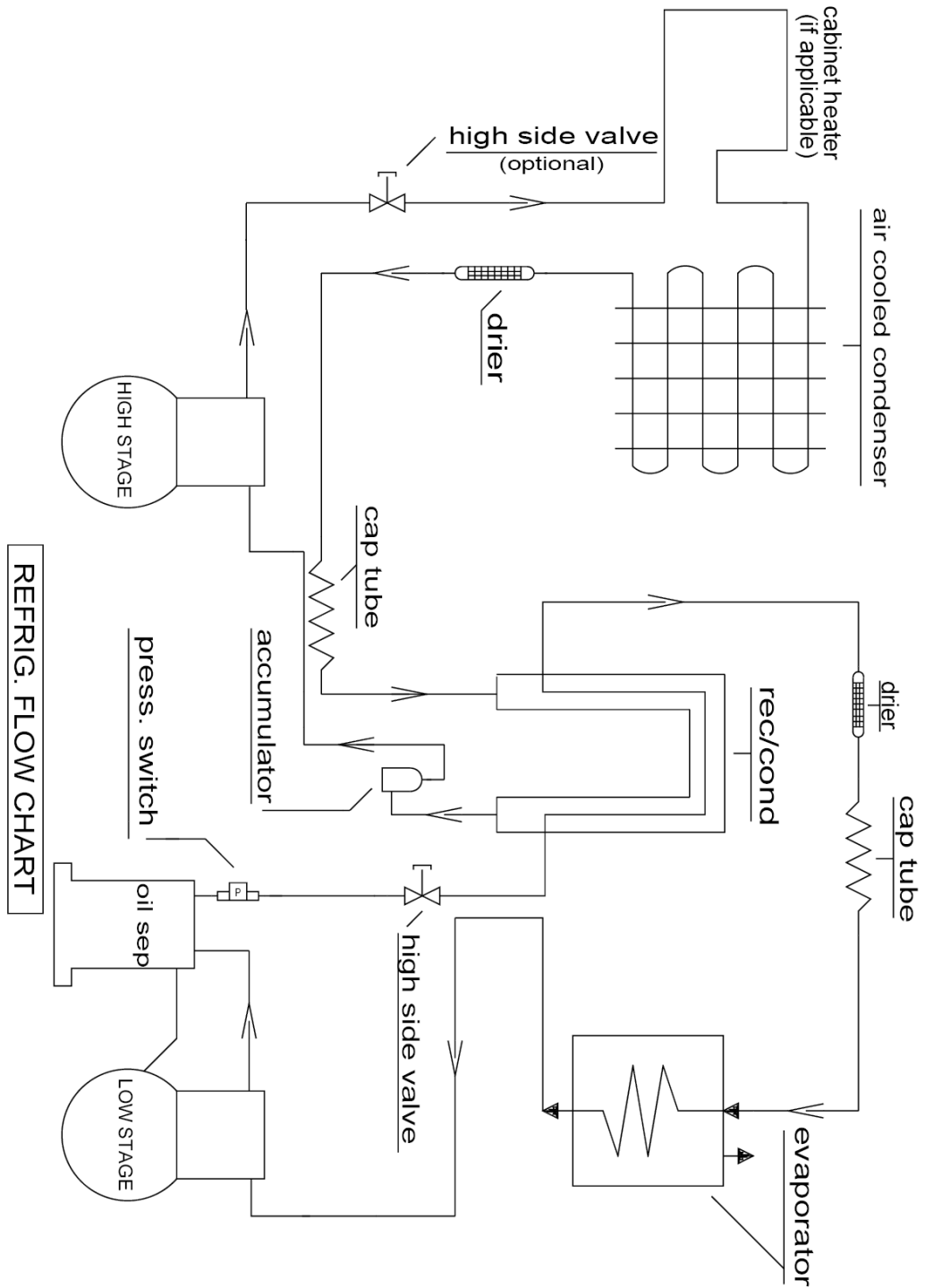

REFRIG. FLOW CHART

HOT GAS BYPASS CASCADE FLOW CHART
4-19-2010