



ULTRA LOW FREEZER MV85 SERIES

INSTRUCTIONS

USER MANUAL

WARNING: READ BEFORE CONTINUING

To reduce the risk of fire, electric shock or injury to persons using this freezer, read all instructions and follow basic safety precautions before using the unit, including the following:



Do not modify the plug provided with the freezer. If it will not fit the outlet, have a proper outlet installed by a qualified electrician.



Do not position equipment so it is difficult to disconnect from the power supply. freezer must be at least 6" away from any wall or object on any side.



While under warranty, do not attempt to repair or replace any part of the freezer for servicing without first contacting the So-Low Service Department.

SAVE THESE INSTRUCTIONS

For customer service:
Email: sales@so-low.com

For parts replacement:
Email: parts@so-low.com

For technical support:
Email: service@so-low.com

MV85 SERIES STARTING GUIDE: READ BEFORE CONTINUING

DO NOT LOAD PRODUCT INTO THE UNIT UNTIL THE SETPOINT TEMPERATURE HAS BEEN REACHED.

Starting the unit:

1. Plug the power cord into the dedicated outlet the unit requires, press the on/off button on the front display.
2. You will be prompted to enter the password. Press the enter button (The default password from the factory is 0000). Press the enter button four times to enter the 0000, then press enter one more time and your unit will start the compressor countdown.
3. After the system checks are complete the compressor will turn on and your unit starts to cool. *
4. The factory setpoint for your unit is -85°C. (If a setpoint change or alarm parameter change is required, please refer to the custom settings section in the manual)

*Please note that during the initial cool down of the unit the high temperature alarm will become active during that time, and you will need to silence the alarm a handful of times by pressing the down arrow on the display. Once the unit has reached the desired setpoint the alarm can be cleared from the display at this time. (Refer to the How to mute and accept alarms section in the manual for further description on how to clear alarms.)

Data Logger:

1. Press the up arrow to generate the temperature graph from the built-in data logger on the control.
2. Press the left arrow to view up to the previous 10 days of the data graph.
3. Press the esc button to exit the menu.

Data download from the unit to a USB drive:

1. Place your USB into the USB-Connection on the front of the display.
2. The read data will be displayed on the screen when the data is being uploaded to the USB.
3. Transfer complete will be shown on the display when the upload is finished, and the USB can be removed from the display.

Temperature Alarm: The temperature alarm will sound if the unit has been out of range for 15 minutes.

1. **High Temperature alarm:** The high temperature alarm is preset to -70°C.
2. **Low Temperature alarm:** The low temperature alarm is preset to -90°C.

CONTENTS

◆ SYMBOLS AND STARTING INSTRUCTIONS	1
• MEANING OF ILLUSTRATED SYMBOLS.....	1
• STARTING INSTRUCTIONS.....	1
◆ UNIT REQUIREMENTS	2
• PRE-INSTALLATION INFORMATION.....	2
◆ GENERAL SPECIFICATIONS	3
• TEMPERATURE SPECIFICATIONS.....	3
• ELECTRICAL SPECIFICATIONS.....	3
◆ REFRIGERATION SPECIFICATIONS AND DEFROSTING	4
◆ MAINTENANCE	5
◆ UNIT OPERATION	6
◆ TEMPERATURE CONTROL	7
◆ ALARM OPERATION	8
• ALARM SYSTEM.....	8
• HOW TO MUTE AND ACCEPT ALARMS	9
◆ CONTROL PROGRAMMING	10
• CUSTOM SETTINGS.....	10
• ADVANCED SETTINGS.....	11
• SERVICE SETTINGS.....	12
• ADVANCD SERVICE SETTINGS.....	12
◆ DATA DOWNLOAD	13
• DOWNLOAD.....	13
• UPLOAD.....	13
◆ FACTORY SETTINGS	14
◆ WIRING DIAGRAM	15
• MV85-1 DIAGRAM.....	16
• MV85-1 PARTS LIST.....	17
• MV85-2 DIAGRAM.....	18
• MV85-2 PARTS LIST.....	19
• MV85-3 DIAGRAM.....	20
• MV85-3 PARTS LIST.....	21
• EXTERNAL PROBE INSTALLATION	22

SYMBOLS AND STARTING INSTRUCTIONS

Explanation

MEANING OF ILLUSTRATED SYMBOLS

ILLUSTRATED SYMBOLS

Various symbols are used in this safety manual in order to use the unit without danger of injury and damage of the unit. A list of problems caused by ignoring the warnings and improper handling is divided as shown below. Be sure that you understand the warnings and cautions in this manual before operating the unit.



CAUTION

BLACK WITH YELLOW BACKGROUND
LIGHTNING BOLT
CAUTION, RISK OF ELECTRICAL SHOCK



WARNING

BLACK WITH YELLOW BACKGROUND
EXCLAMATION POINT
CAUTION, REFER TO ACCOMPANYING DOCUMENTS

STARTING INSTRUCTIONS

1. Move the freezer to an indoor location, and plug the freezer into an appropriate outlet with an adequate power supply. Consult your maintenance department for additional information on the proper electrical configuration for this unit.
2. Once plugged in, the compressor(s) will start to operate and pull down to the setpoint on the temperature control.
3. Allow the freezer to reach the setpoint temperature. Depending on the size of the unit, this may take up to 12 hours.
4. Product can now be loaded into the freezer for storage.

Unit Information

PRE-INSTALLATION INFORMATION

RANGE OF ENVIRONMENTAL CONDITIONS FOR WHICH THIS EQUIPMENT IS DESIGNED

1. Indoor use.
2. Altitude up to 2000m.
3. Ambient temperatures 15°C to 30°C (60°F TO 85°F)
4. Recommended humidity range of 30% to 90%.
5. Mains supply fluctuations up to -5% to +10% of the nominal voltage.
6. Transient over-voltages typically present on the mains supply (overvoltage category II). Pollution degree 1.



WARNING

THIS FREEZER IS PROVIDED WITH AN INPUT CIRCUIT PROTECTIVE DEVICE WHICH SHALL BE MAINTAINED AND SERVICED BY QUALIFIED PERSONNEL ONLY.



CAUTION

UNDER NO CIRCUMSTANCES USE EXTENSION LEADS OR ADAPTORS. CONNECT THE APPLIANCE DIRECTLY TO A FIXED INSTALLATION. IF THE APPLIANCE IS CONNECTED TO A LONG EXTENSION CABLE THERE IS A RISK THAT THE CABLE WILL BECOME HOT.



CAUTION

UNPLUG FREEZER BEFORE ANY TECHNICAL SERVICE IS PERFORMED ON THE UNIT.



WARNING

DO NOT POSITION EQUIPMENT SO IT IS DIFFICULT TO DISCONNECT FROM THE POWER SUPPLY.

GENERAL SPECIFICATIONS

Specifications

TEMPERATURE SPECIFICATIONS

OPERATIONAL TEMPERATURE RANGE

-40°C TO -85°C

ELECTRICAL SPECIFICATIONS

ELECTRICAL PLUG

- Plug the freezer into the proper outlet with an adequate power supply.
- This unit requires a **Dedicated Electrical Line**.

MODEL	VOLTAGE	AMPERAGE	PLUG
MV85-1 MV85-2 MV85-3	115 VOLTS 60 HERTZ 1 PHASE	15 AMP DEDICATED LINE	 NEMA 5-15



WARNING

ONLY PLUG THIS UNIT INTO THE PROPER OUTLET. DO NOT ATTEMPT TO MODIFY PLUG IN ANY WAY. IMPROPER USE OF THE ELECTRICAL PLUG WILL VOID WARRANTY



CAUTION

FAILURE TO GROUND THE EQUIPMENT MAY CAUSE PERSONAL INJURY OR DAMAGE TO THE EQUIPMENT. ALWAYS CONFORM TO THE ELECTRICAL CODES.

REFRIGERATION SPECIFICATIONS

REFRIGERATION SPECIFICATIONS

MODEL	CU. FT.	REFRIGERATION SYSTEM	REFRIGERANT
MV85-1	0.25	3/8 HP REFRIGERATION SYSTEM	EP88 – 6.10 OZ.
MV85-2	2	3/8 HP REFRIGERATION SYSTEM	EP88 – 6.88 OZ.
MV85-3	3	3/8 HP REFRIGERATION SYSTEM	EP88 – 6.90 OZ.

DEFROSTING

This appliance does not offer automatic defrosting as such function would increase the chamber temperature (and stored samples) to a value that could destroy stored samples that are temperature sensitive. Therefore, you have to perform defrosting manually by following these instructions:

Defrost the appliance at least twice a year.

1. If the appliance is loaded with samples or products, move these to another appliance to maintain the temperature of the products.
2. Turn off the appliance on the display by pressing the ON/OFF button.
3. Unplug the main power cable from the power socket.
4. Open the door and inner doors of the appliance.
5. Place cloths or towels in the bottom of the appliance to collect any defrost water.
6. Leave the appliance open for a minimum of 24 hours allowing the ice to melt.

PREVENTATIVE MAINTENANCE

BEFORE PERFORMING MAINTENANCE

To reduce the risk of fire, electric shock or injury to persons using this freezer, read all instructions and follow basic safety precautions.



CAUTION

DISCONNECT THIS UNIT FROM THE POWER SUPPLY BEFORE PERFORMING MAINTENANCE ON THE UNIT.

CLEANING PROCEDURE

- Wipe down the exterior of the freezer with a soft cloth and spray type polish.
- The freezer may also be cleaned with a hospital grade cleaner.
- If frost builds up in the chamber, a bucket and ice-scraper can be used to remove the ice.
- If excessive ice builds up, the unit can be defrosted (see below).

DEFROST PROCEDURE

1. Remove any product in the freezer and store it in a back-up freezer or elsewhere.
 2. Unplug the freezer, and open the freezer front door / lid.
 3. Use a cloth to protect the control from dripping water.
 4. Air out the freezer for at least 12 hours, allowing the unit to reach room temperature.
 5. Take a rag and wipe up all the excess water in the unit (melted frost).
 6. Plug the unit in and set your temperature to the desired setpoint
 7. Once the desired temperature is reached, add product back into the unit.
-
-



WARNING

IT IS RECOMMENDED TO SLOWLY RE-ADD YOUR PRODUCT INTO THE FREEZER TO PREVENT AN EXTREME LOAD ON THE COMPRESSORS, WHICH COULD SHORTEN FREEZER LIFE EXPECTANCY.

GENERAL OPERATION

- The freezer should be located in a dry, cool place without direct sunlight.
- To start the freezer, set the digital thermometer at the temperature required. It will now take about 6-10 hours before the set temperature is reached.
- The freezer should be cooled down empty.



WARNING

WHEN FILLING THE UNIT WITH RACKS/BOXES, MAKE SURE TO PRE-COOL THEM IN ORDER NOT TO EFFECT THE INSIDE TEMPERATURE OF THE UNIT.



WARNING

THE INNER DOORS SHOULD BE USED AT ALL TIMES. MAKE SURE TO CLOSE THEM TIGHTLY.

THE MANUFACTURER IS NOT RESPONSIBLE FOR DAMAGE TO THE FREEZER CAUSED BY FAILURE TO DO SO.



WARNING

CLEAN THE FREEZER BOTH INSIDE AND OUT USING A DAMP, WRUNG OUT CLOTH. DRY WITH A DRY CLOTH.

THE SMELL FROM THE PLASTIC PARTS IN THE FREEZER WILL DISAPPEAR ONCE THE FREEZER HAS BEEN COOLED DOWN.

G-214 CONTROLLER

CONTROL DISPLAY

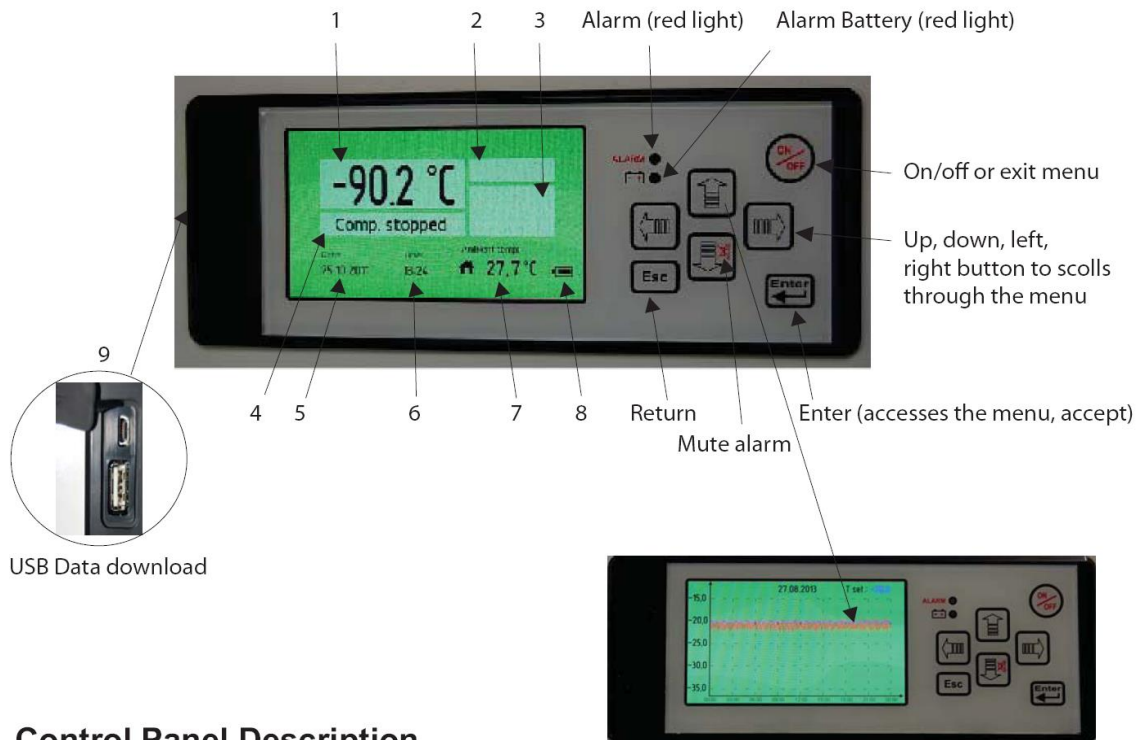

Control Panel Description

1. Temperature indicator
2. Alarm indicator
3. Alarm-icons
4. Compressor indication
5. Date indication
6. Hour indication
7. Ambient temperature indicator
8. Battery level
9. USB-Connection

Push the **UP** button in order to generate a graph.

Push the **LEFT** button in order to return up to 10 days back.

Push the **Esc** button in order to exit the menu.

ALARM SYSTEM

Alarms on display



Alarm icons



Door open alarm

The **Door open alarm** indicate, that the door is not correct closed



High temp. alarm

The **High temperature alarm** indicate, that the temperature inside the unit is higher than permitted from setting of the unit.



Low temp. alarm

The **Low temperature alarm** indicate, that the temperature inside the unit is lower than permitted from setting of the unit.



Probe eeprom failure

The **Probe eeprom failure** alarm indicate, that the probe is not working.



Power failure

The **Power failure** alarm indicate, that there is no power to the unit.



Low battery

The **Low battery** alarm indicate, that the power on the battery is to low.

HOW TO MUTE AND ACCEPT ALARMS

Mute an alarm

Press the Alarm mute button to mute an alarm. This procedure will silence the alarm for 5 min, where after it will start sounding again until being muted or accepted.

* Please note that muting an alarm will only silence the alarm, the alarm is still active.

Accept an alarm

Press Enter to show an alarm (if an alarm is active).

- Select Back to return to main screen
- Select Next to see other active alarms
- Select OK to accept the shown alarm

If multiple alarms are active, the next alarm will be shown after accepting the previous alarm.

Please note that accepting an alarm will definitively cancel the current alarm.

(if the alarm conditions remain unchanged, a new alarm will be activated according to the alarm settings).

Remote alarm contact

The alarm relay will not be switched off when muting an alarm.

If all alarms are accepted, the remote alarm will be turned off.

CUSTOM SETTINGS

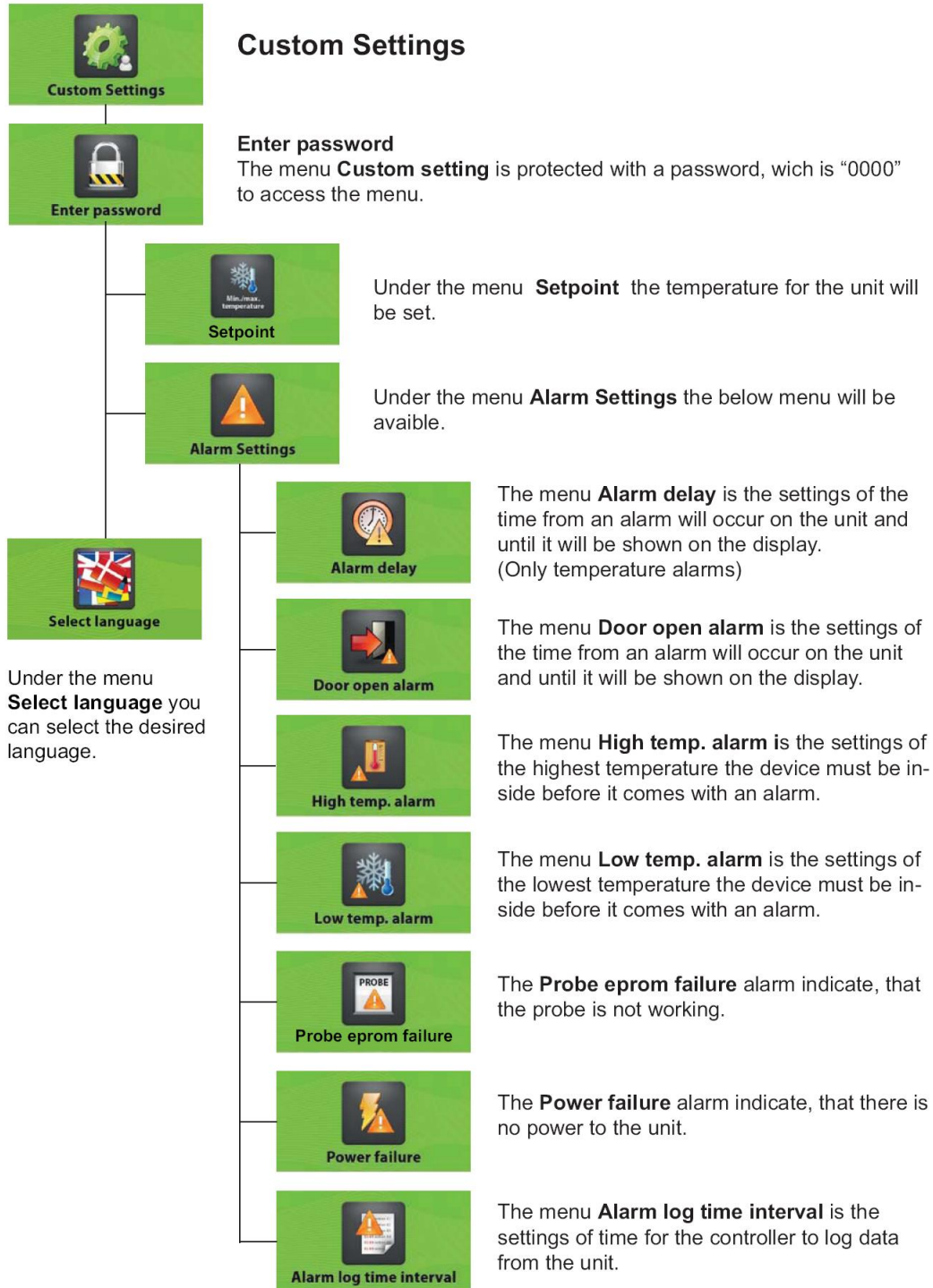

ADVANCED SETTINGS



Advanced Settings

Advanced Settings



Enter password

Enter password

The menu **Advanced Settings** is protected with a password which is "0000" to access the menu.



Calibration

The menu **Calibration** is the settings for offset of the temperature in the display.



Automatic defrost

The menu **Automatic defrost** is the setting of the time where a defrost automatic will be performed on the unit.



Manual defrost

Under the menu **Manual defrost** the defrost can be started immediately.

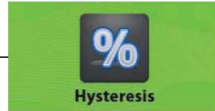

Hysteresis

The menu **Hysteresis** is the setting of the different from the setpoint where the compressor will start and stop.



Temp. range limits

The menu **Temp. range limits** is the settings of the maximum and minimum temperature the unit can be used for.

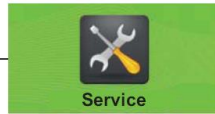

Service

Service

See Page 10



Password protection

The menu **Password protection** is the setting of the protection for the unit not to be turn off and is protected with a password.



Set date / time

The menu **Set date / time** is the setting of date and time.



Ambient temp. settings

The menu **Ambient temp. settings** is the adjustment of the ambient temperature.

SERVICE SETTINGS



Service

Service Settings

Under the menu **Service**, there is information about the unit, which is important for service on the unit.



Compressor hours

The menu **Compressor hours** shows, how many hours the compressor has run.



Fan hours

The menu **Fan hours** shows, how many hours the fan has run.



Probe

Under the menu **Probe** the temperature for the sensor mounted in the unit is displayed.



Probe inside unit

Under the menu **Probe inside unit** the temperature of the sensor mounted inside the unit is displayed. There is mounted a sensor as standard in the unit, but it is possible to mount 3 sensors inside the device. (Controller version)



Probe Compressor

Under the item **Probe Compressor** the temperature of the sensor mounted on the compressor is displayed. (Not all models)



Probe evaporator

Under the point **Probe evaporator** the temperature of the sensor, that is located on the condenser, is displayed.

ADVANCED SERVICE SETTINGS



Advanced Service Settings

Advanced Service Settings

This menu is only used by the service department at the manufacturer.

DOWNLOAD

Download Data



Place the USB pen drive in the connection on the display and press the button right for **read data** from the unit to the USB pen.



The **Read data** will be shown in the display when the data is loading to the USB pen drive.

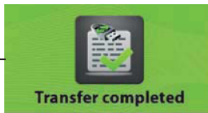

The **Transfer complete** will be shown on the display when the loading is finished and the USB pen can be removed from the display.

Open the 2 files:
data00 and **param00**
on a computer in Excel or similar.

UPLOAD

Upload Data (Only for new settings from the manufactory)



Turn-off the display before start.
Place the USB pen drive in the connection on the display and press the button left for upload parameters from the USB pen to the unit.



The **Data upload** will be shown in the display when the data is loading to the unit.

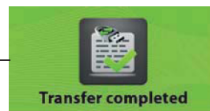

The **Transfer complete** will be shown on the display when the loading is finished and the USB pen can be removed from the display.

FACTORY SETTINGS

BASIC SETTINGS

DESCRIPTION	DEFAULT SETTINGS	CUSTOMER SETTING
PASSWORD	0000	
TEMPERATURE SETPOINT	-80.0	
ALARM – DELAY	15 Min	
ALARM – DOOR OPEN	Enable	
ALARM – HIGH TEMPERATURE	-70	
ALARM – LOW TEMPERATURE	-90	
ALARM – LOG TIME INTERVAL	1	
PROBE (EPROM) FAILURE	Enable	
POWER FAILURE	Enable	

ADVANCED SETTINGS

DESCRIPTION	DEFAULT SETTINGS	CUSTOMER SETTING
PASSWORD	0000	
CALIBRATION	0.0	
AUTOMATIC DEFROST	0	
MANUAL DEFROST	OK	
HYSTERESIS	2.0	
MAXIMUM RANGE LIMIT	-40	
MINIMUM RANGE LIMIT	-86	

WIRING DIAGRAM

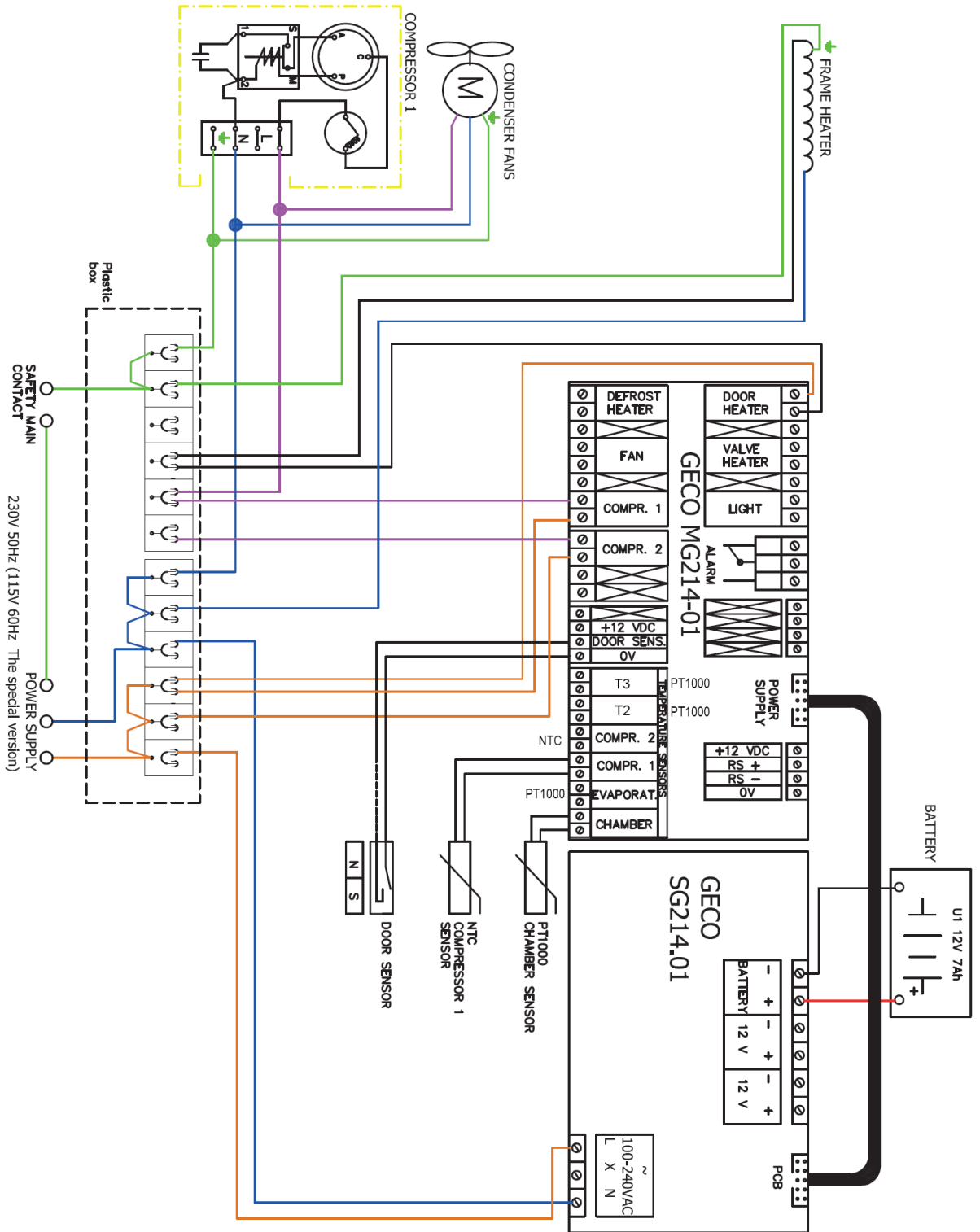

MV85-1 DIAGRAM

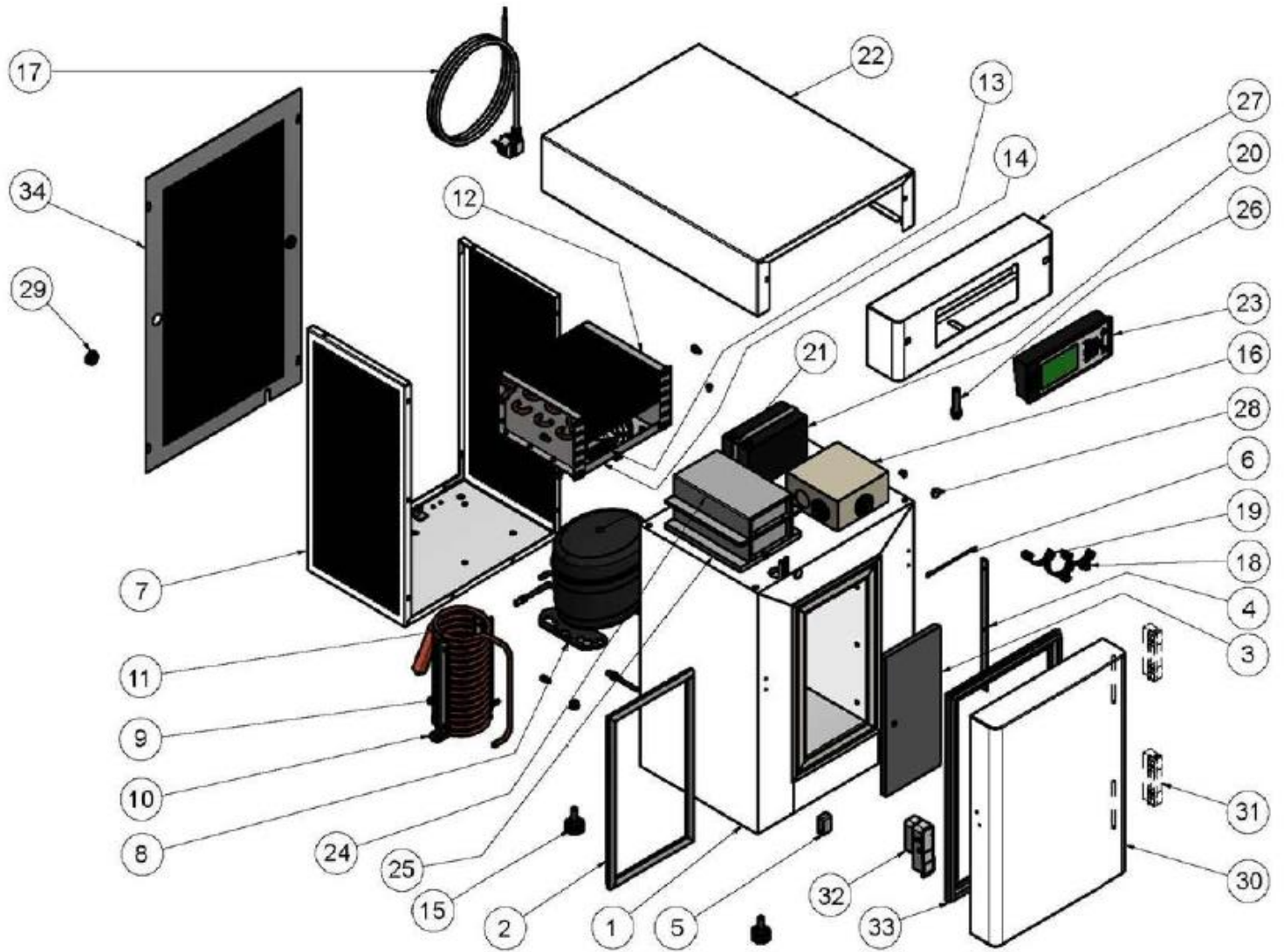

MV85-1 PARTS LIST

Pos. no.	Code no.	Part	Recommended
1	-	Cabinet	
2	5052159-01	Gasket for frame (silicone)	
3	5052136-01	Inner door	
4	5031218-01	Hinge for inner door - 280mm	
5	5051065-01	Handle (Belt) for inner door	
6	5042003-01	Probe (PT1000)	x
7	5031228-01	Aggregate cover	
8	5070007-01	Compresseor SC12CNX.2	
9	5074003-01	Condenser spiral	
10	5031234-01	Condenser spiral support 1	
11	5031235-01	Condenser spiral support 2	
12	5071039-01	Condenser TK0680	
13	5010007-01	Condenser fan ex.wing	x
14	5010043-01	Fan wing	
15	5053030-01	Regulated feet	
16	5049006-01	Electrical box for 230V connection G-214	
17	5019169-01	Mains lead ULUF	
18	5019128-01	Flat cable G-214 PCB and PSU	
19	5019017-01	Flat cable G-214 display	
20	5044001-01	Battery G-210/214 controller	x
21	5031192-01	Battery support	
22	5031230-01	Top cover ULUF 15	
23	5043007-01	Display for G-214	x
24	5041007-01	Power supply G-214	x
25	5041006-01	PCB-board G-214	x
26	5019113-01	Door switch	
27	5031231-01	Front panel	
28	5030098-01	Hole plug for cabinet	
29	5030099-01	Hole cover for back cover	
30	5052156-01	Door ULUF 15	
31	5031025-01	Hinges	
32	5051006-01	Lock A-458-R	
33	5052158-01	Door magnet. Gasket ULUF 15	
34	5031229-01	Back cover	
-	5079000-01	Service dryfilter	x
-	5072000-01	Cylinder + deposit	x
-	5072023-01	Refrigerant EP88 - 173g	x

MV85-2 DIAGRAM

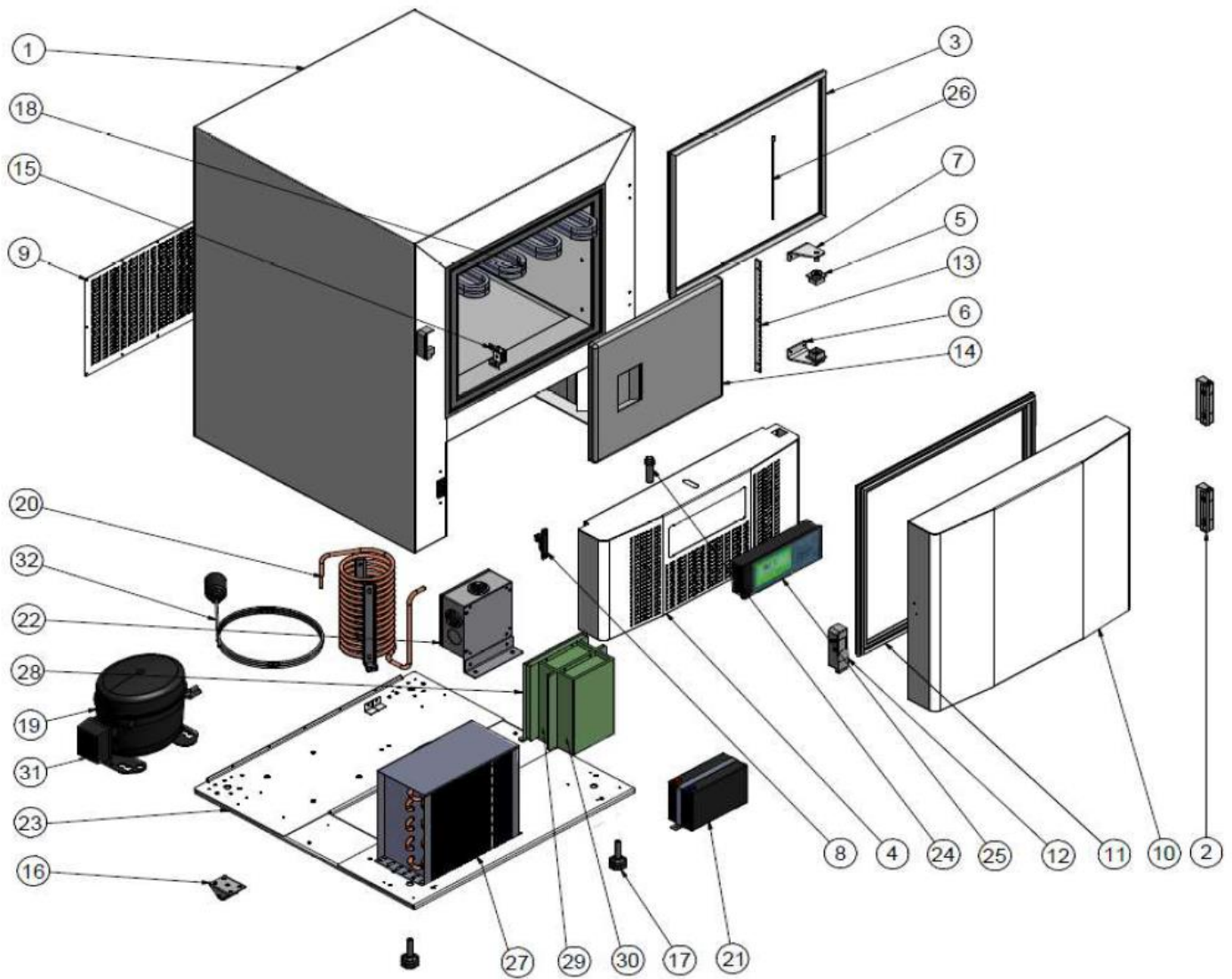

MV85-3 DIAGRAM

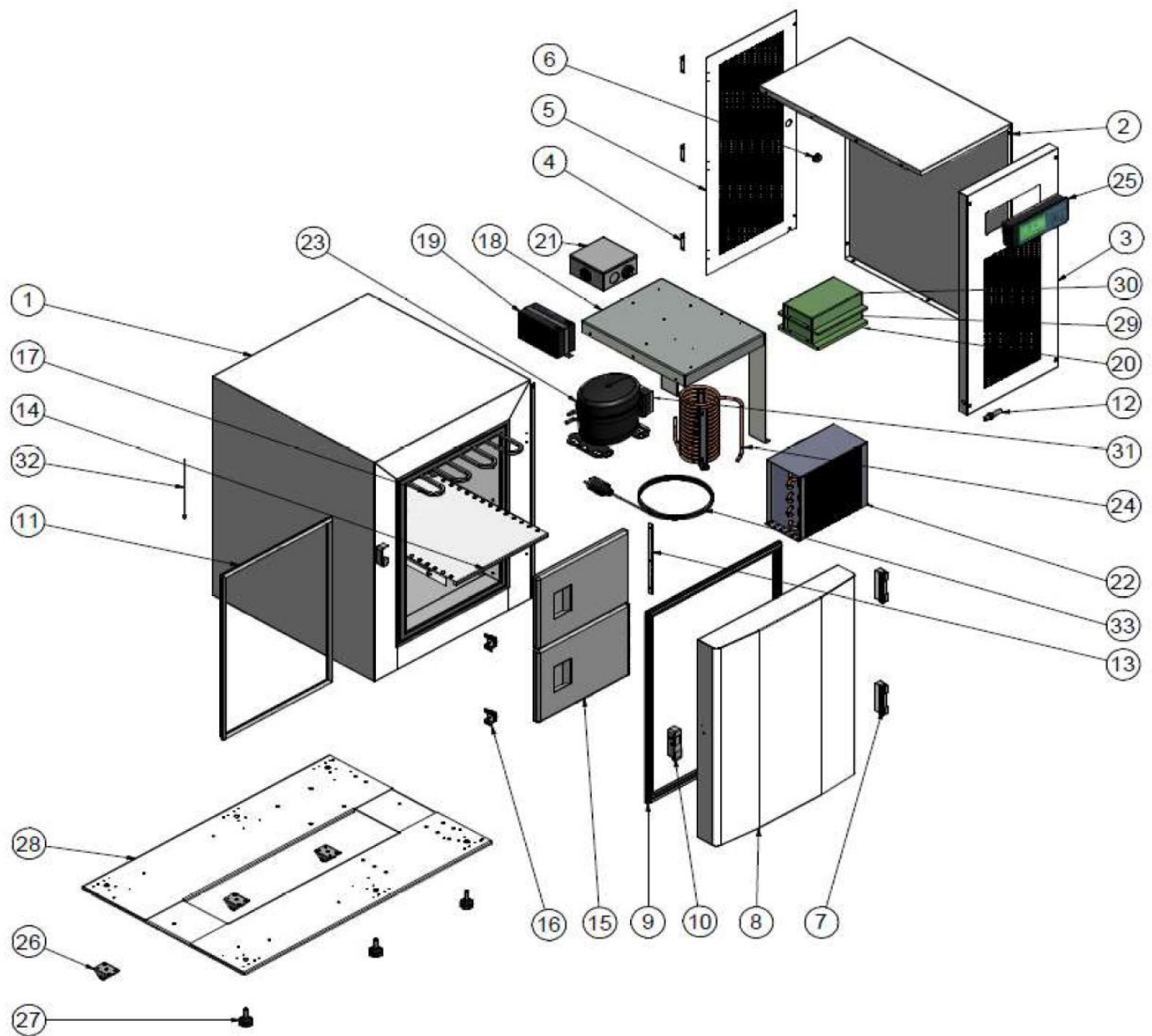

EXTERNAL PROBE INSTALLATION MV85 SERIES

Method 1: Using the pre-drilled port hole (not available on all units)

Step 1 – Find the pre-drilled port hole in the back of the cabinet. It is placed behind the yellow sticker.

Use a screwdriver or similar object to punch a hole through the sealant. It's important to note that you must use putty to seal the hole once the probe is installed.

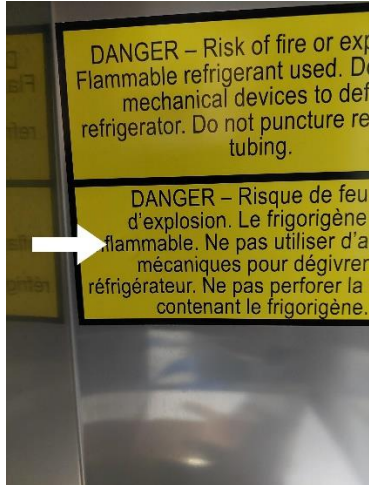

Step 2 – Open the back cover of the unit to find the other side of the pre-drilled hole. This requires a Phillips head screwdriver. Loosen the 4 screws on the sides until the cover can be lifted off.

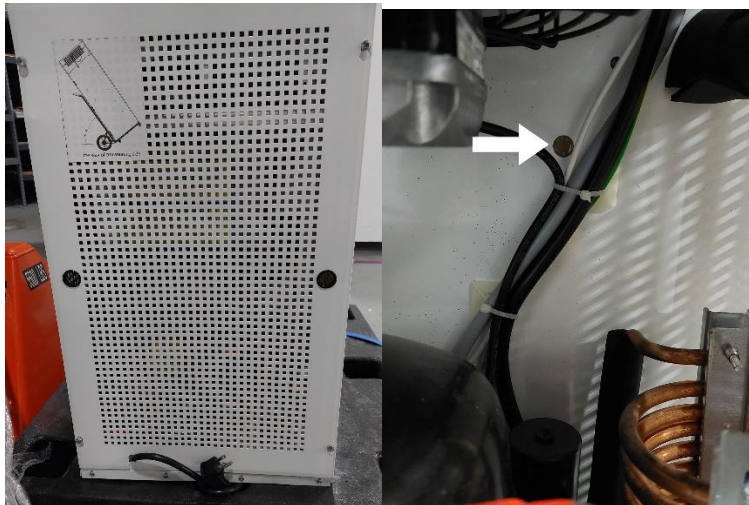

Step 3 – Insert the probe through the port hole and secure it inside the cabinet so that it's not touching the walls. For best results, follow the manufacturer's instructions for placement. If recommended, place the probe in a bottle of glycerin inside the cabinet. Once the probe is placed, seal both sides of the port hole with putty. Make sure there are no gaps for cold air to escape as this will affect the temperature stability of your freezer.

Method 2: (For units that do not have the external port hole pre-drilled) Follow the internal probe

Step 1 – Remove the front panel of the unit. To do this, pop off the white button covers on both sides of the controller. You can use a fingernail or gently use a screwdriver being careful not to scratch the paint.



Use a long handled Phillips head screwdriver to loosen the screws that are behind each hole. You don't need to remove the screw, just loosen it enough that the top panel will pull up and then out.

-Once the screws are loosened, pull the top panel up and then out. It will still be connected to the freezer via wires so carefully set it out of the way. We recommend using a soft cloth to protect the paint and controller while you're working.

Step 2 – Remove the back cover of the unit. (Just like in the pre-drilled method.)

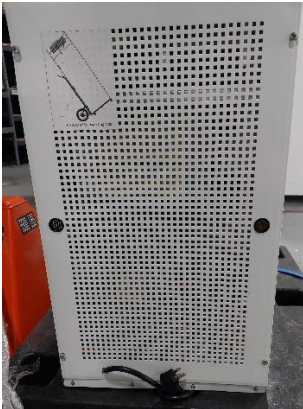

Step 3 – Using an 8 mm socket, remove 6 bolts from inside the top cover so it can be removed. The bolts are found both the left and right side of the cover, in the front, back, and center of the unit.



Once these are removed, gently pull the top panel off. Make a note of which side is the front and which is the back. It will not go back on properly if it's placed on the wrong way.

Step 4 – Locate the internal probe. It is an orange wire that runs from the back of the unit up to the front and then goes down into the chamber. The port hole where it enters the chamber is sealed with putty. It's recommended to replace the putty with new if it looks old or feels dry to ensure a good seal on the cabinet. To insert an external probe into the same hole, remove the putty so the hole is visible and another probe can be inserted alongside the existing one.

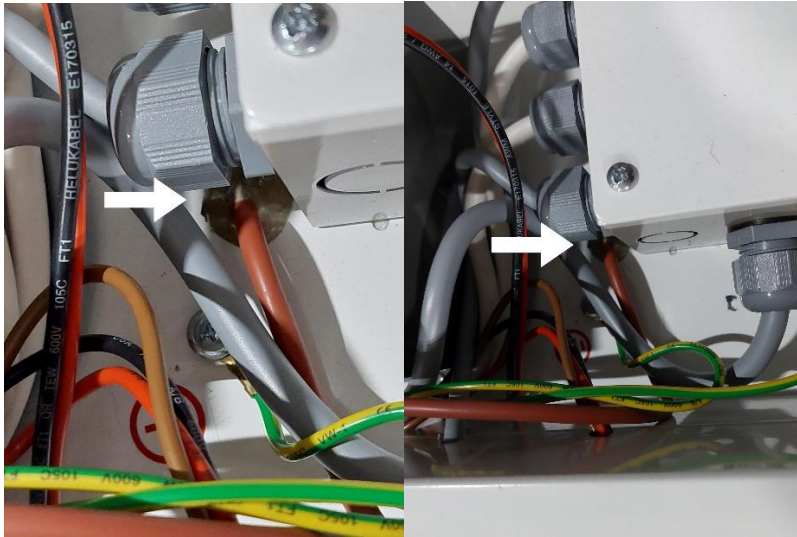

You will also need to remove the putty inside the cabinet where the existing probe enters the chamber. Once the external probe is inserted and properly placed, reseal this hole with putty.