

MODEL NC85-2

2 CUBIC FOOT ULTRA LOW TEMPERATURE FREEZER

	WIDTH	DEPTH	HEIGHT	WIDTH	DEPTH	HEIGHT
INTERIOR DIMENSIONS	17 IN	14 IN	14 IN	43 CM	35 CM	35 CM
EXTERIOR DIMENSIONS	25.25 IN	25.75 IN	40 IN	64 CM	65 CM	101 CM
CRATED DIMENSIONS	31 IN	31 IN	48 IN	78 CM	78 CM	121 CM

NOTE THAT THE FREEZER LID CAN OPEN UP TO APPROXIMATELY 75° FROM HORIZONTAL POSITION

SIDE VIEW

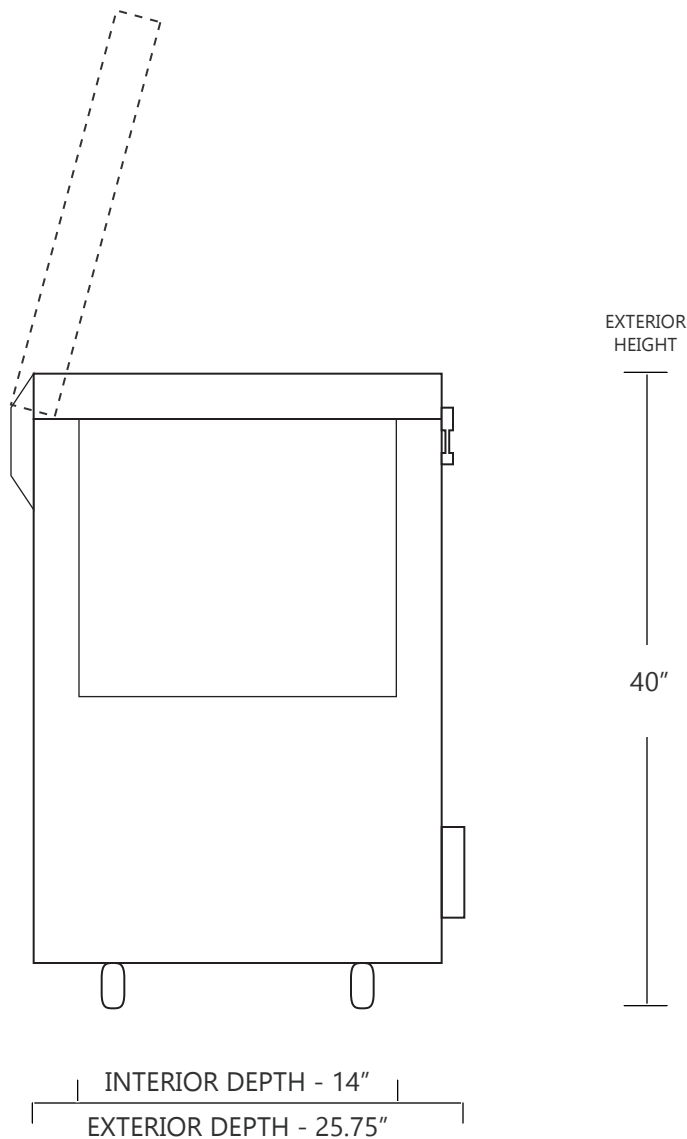

FRONT VIEW

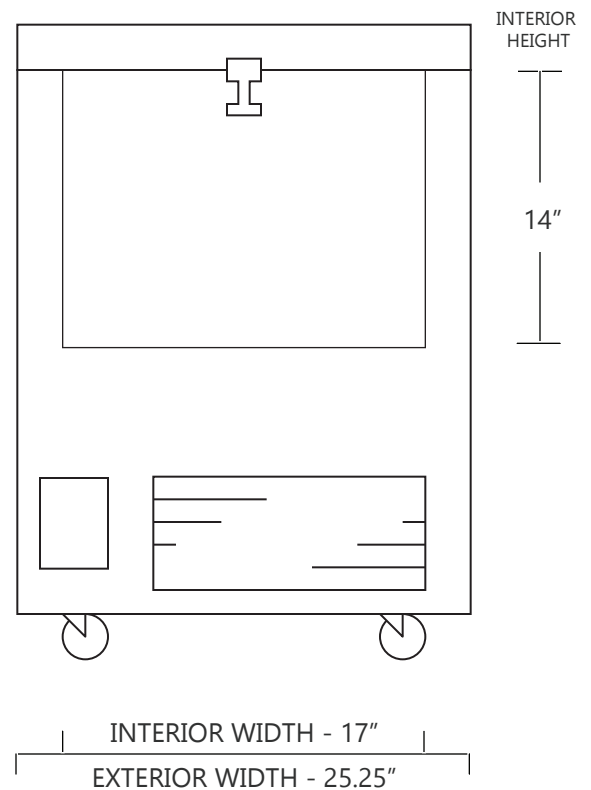

SO-LOW



NET WEIGHT : 300 LBS.
SHIPPING WEIGHT: 335 LBS.

SHIPPING OPTIONS

DOCK-TO-DOCK DELIVERY (REQUIRES FORKLIFT OR PALLET JACK)
DOCK-TO-DOCK DELIVERY WITH LIFTGATE (REQUIRES FORKLIFT OR PALLET JACK)
INSIDE DELIVERY (WHITE GLOVE DELIVERY)