



Explorer Plus™ Balances

Instruction Manual



Version History

Date	Version	Description
2025/7/15	A	<ul style="list-style-type: none"><li data-bbox="667 286 874 315">• Initial release
2025/9/26	B	<ul style="list-style-type: none"><li data-bbox="667 347 890 376">• Add accessory<li data-bbox="667 398 970 427">• Update specifications<li data-bbox="667 450 1050 479">• Update interface commands<li data-bbox="667 501 995 530">• Update span calibration<li data-bbox="667 553 1145 582">• Update preset user role accessibility

TABLE OF CONTENTS

1	INTRODUCTION	8
1.1	Description.....	8
1.2	Features.....	8
1.2.1	Display.....	8
1.2.2	Modular Design.....	8
1.2.3	Digital Loadcell with Advanced Environmental Sensors.....	8
1.2.4	Removable Draftshield Design.....	8
1.2.5	Motorized Leveling System.....	8
1.2.6	Automatic Draftshield Doors.....	8
1.2.7	Status Lights and Sample Spotlights.....	8
1.2.8	HID Data Transfer Function.....	8
1.2.9	Time Synchronization NTP (Network Time Protocol).....	8
1.2.10	Fingerprint login System (Accessory).....	8
2	Safety Precautions	9
2.1	Intended Use.....	9
2.2	Definition of Signal Warnings and Symbols.....	9
2.3	Safety Notes.....	9
3	Installation	11
3.1	Unpacking.....	11
3.2	Installing Components.....	11
3.2.1	For 0.01mg, 0.1mg, and 1mg Models.....	11
3.2.2	For 0.01g, and 0.1g Models.....	11
3.2.3	For High-Capacity Models.....	12
3.2.4	Selecting a Location.....	12
3.3	Connecting Power.....	13
3.4	Turn on the balance.....	13
3.5	Adjust the viewing angles.....	14
3.5.1	Level the Balance Before Use.....	14
3.6	Disconnect the terminal from the weighing base.....	15
3.7	Remove Draftshield from the Base.....	15
3.8	Connecting the Interface.....	16
3.9	Install the rechargeable battery for High-Capacity Models.....	17
3.10	Overview of Parts and Features –Draft Shield Models.....	18
3.10.1	Side View.....	18
3.10.2	Rear View.....	18
3.10.3	Below Weighing Hock.....	19
3.11	Overview of Parts and Features –Non-Draft Shield Models.....	19

3.11.1	Side View	19
3.11.2	Rear View	20
3.12	Overview of High-Capacity Models	20
3.12.1	Side View	20
3.12.2	Rear View	20
3.13	Overview of Terminal	21
3.14	Main Screen Features	22
3.15	Warning and Notifications	23
3.15.1	Calibration Failure	23
3.15.2	Leveling Required	23
3.15.3	Password Expiration	24
3.16	Hotkeys	24
3.16.1	Standard Hotkeys	24
3.16.2	Additional Hotkeys (Add+)	26
3.17	Shortcut Buttons	26
3.18	Digital loadcell Environmental Sensors	26
3.19	HID Connections	26
3.19.1	English Keyboard	26
3.19.2	French Keyboard	27
4	Weighing Application Modes	28
4.1	Introduction	28
4.2	Basic Weighing	29
4.2.1	Weighing Result	29
4.2.2	Reference Fields – Basic Weighing	29
4.2.3	Item Setting	30
4.2.4	Minimum Weight	30
4.2.5	Set minimum weight value	31
4.2.6	Auto Tare	31
4.2.7	Sample Library	31
4.2.8	Printing Settings	32
4.2.9	Shortcut Buttons	32
4.3	Parts Counting	34
4.3.1	Application buttons	34
4.3.2	Begin Parts Counting	34
4.3.3	Accumulate the data for Parts Counting	36
4.3.4	Sample Library – Parts Counting	36
4.3.5	Printing Settings	37
4.4	Check Counting	38

4.4.1	Application buttons and Reference Field	38
4.4.2	Begin Check Counting	39
4.4.3	Accumulate the data for Check Counting	40
4.4.4	Sample Library – Check Counting	41
4.4.5	Printing Settings	42
4.5	Percent Weighing	42
4.5.1	Application buttons and Reference Field	42
4.5.2	Begin Percent Weighing.....	43
4.5.3	Accumulate the data for Percent Weighing.....	44
4.5.4	Sample Library – Check Counting	45
4.5.5	Printing Settings	45
4.6	Check Weighing.....	46
4.6.1	Reference Field.....	46
4.6.2	Begin Check Weighing.....	47
4.6.3	Sample Library – Check Weighing.....	49
4.6.4	Printing Settings	50
4.7	Dynamic Weighing	50
4.7.1	Application buttons.....	50
4.7.2	Begin Check Weighing.....	51
4.7.3	Sample Library – Dynamic Weighing.....	51
4.7.4	Printing Settings	52
4.8	Totalization.....	52
4.8.1	Application buttons.....	53
4.8.2	Begin Totalization.....	53
4.8.3	Accumulate the data for Totalization.....	54
4.8.4	Sample Library – Totalization	54
4.8.5	Printing Settings	55
4.9	Formulation	55
4.9.1	Application buttons.....	55
4.9.2	Begin Free Formulation.....	56
4.9.3	Begin Recipe Based Formulation	57
4.9.4	Printing Settings	58
4.10	Differential.....	59
4.10.1	Application Buttons	59
4.10.2	Begin Differential Weighing	60
4.10.3	Printing Settings.....	61
4.11	Density Determination	62
4.11.1	Application Buttons/ Reference Field	62

4.11.2	The Density Result Resolution	63
4.11.3	Begin Density Determination for Solid Material	63
4.11.4	Begin Density Determination for Porous Material	66
4.11.5	Begin Density Determination for Liquid Material	67
4.11.6	Sample Library – Density Determination	68
4.11.7	Printing Settings.....	69
4.12	Peak Hold	70
4.12.1	Application Buttons/ Reference Field	70
4.12.2	Begin with Peak Hold.....	71
4.12.3	Begin with Display Hold	71
4.12.4	Sample Library – Peak Hold	72
4.12.5	Printing Settings.....	72
4.13	Pipette Adjustment.....	73
4.13.1	Application Buttons/ Reference Field	73
4.13.2	Create Method	74
4.13.3	Start Pipette Adjustment	75
4.13.4	View Result.....	76
4.13.5	Printing Settings.....	76
4.14	Statistic Quality Control (SQC).....	76
4.14.1	Application Buttons/ Reference Field	77
4.14.2	Acceptance Criterion	77
4.14.3	Inspection Sample Number and Criterion Table.....	77
4.14.4	Tolerance	78
4.14.5	Create Batch	78
4.14.6	Begin the SQC Process.....	80
4.14.7	Printing Settings.....	81
4.15	Fill Weight Variation	82
4.15.1	Application buttons/ Reference Fields	82
4.15.2	Begin the Fill Weight Variation.....	83
4.15.3	Sample Information – Flow Rate Control.....	85
4.15.4	Printing Settings.....	85
4.16	Flow Rate Control	86
4.16.1	Application Buttons/ Reference Field	86
4.16.2	Flow Rate Control Setting.....	87
4.16.3	Begin the Flow Rate Control.....	88
4.16.4	Begin the Target Control Mode	90
4.16.5	Sample Library – Flow Rate Control.....	91
4.16.6	Printing Settings.....	92

5	Menu Settings	93
5.1	Menu Navigation	93
5.2	Menu Structure	93
5.3	Quick Setup	94
5.3.1	Language	94
5.3.2	Time Synchronization/ Network Server	94
5.3.3	Date and Time	95
5.3.4	Automatic Calibration	95
5.3.5	User Management	95
5.3.6	System Log	95
5.3.7	Balance Information	96
5.3.8	Motorized Leveling	96
5.3.9	Repeatability Test	97
5.4	Calibration	98
5.4.1	Calibration Settings	98
5.4.2	Internal Calibration	99
5.4.3	Span Calibration	100
5.4.4	Calibration History	101
5.5	Balance Setup	101
5.5.1	Language	102
5.5.2	Time Synchronization/ Network Server	102
5.5.3	Date and Time	102
5.5.4	Balance Name	102
5.5.5	Change Password	103
5.5.6	Fingerprint/ Fingerprint Setting	103
5.5.7	Filter Level	105
5.5.8	Stability Indicator Range	105
5.5.9	Auto Zero Tracking	105
5.5.10	Gross Indicator	105
5.5.11	Graduation	106
5.5.12	Ionizer	106
5.5.13	Approved Mode	106
5.6	Auto Door	107
5.7	Sensor	108
5.8	System Log	108
5.9	ECO	109
5.9.1	Power Saving	109
5.9.2	Brightness	110

5.9.3	Volume	110
5.9.4	Status lights.....	110
5.10	User Management	110
5.10.1	Create, Edit Delete a User	111
5.10.2	Preset User Role Accessibility.....	111
5.10.3	Group User Permissions.....	112
5.10.4	Password Policy	112
5.11	Application Modes	113
5.12	Weighing Units.....	113
5.13	Communication.....	115
5.13.1	RS232	115
5.13.2	RS232 (DB9) Pin Connections	116
5.13.3	Connections for the Label Printer	116
5.13.4	USB.....	117
5.13.5	Ethernet	118
5.13.6	WI-FI & Bluetooth	118
6	Print Setting	120
6.1	Print Content.....	120
6.2	Connect to Printer	121
6.3	Connect to PC.....	121
6.4	Data to Excel.....	122
6.5	Save to USB	123
6.5.1	Application Print Out Template	124
6.6	Printout Examples.....	129
6.6.1	Calibration Report Template	129
6.6.2	Export to PDF for Batch Printing Example.....	130
7	Library	131
7.1	Library Data	131
7.2	Import and Export Library	132
8	Maintenance.....	133
8.1	Maintenance Menu	133
8.2	Software Upgrade.....	134
8.2.1	Software Upgrade Process	134
8.2.2	Balance Information	134
8.3	Service Menu.....	134
8.4	Service Log File	135
8.5	Factory Reset.....	135
8.6	Log Off	135

8.7	Power Off	135
9	Legal For Trade Application.....	136
9.1	Legal for Trade Setting	136
9.2	Balance Setting Changes	137
9.3	Verification	138
9.4	Sealing	138
9.5	Output Format.....	138
10	MAINTENANCE.....	139
10.1	Calibration.....	139
10.2	Cleaning.....	139
10.3	Battery Power	139
10.4	Troubleshooting	139
10.5	End of Life Instruction	140
10.5.1	Material Composition of 1mg, 0.1mg and 0.01mg Draftshield Models.....	140
10.6	Service Information.....	141
11	TECHNICAL DATA.....	142
11.1	Specifications.....	142
11.2	Model Specification Tables	143
11.3	Accessory Specifications	149
11.4	Drawings and Dimensions	150
11.5	Accessories.....	151
11.6	Interface Commands	154
12	COMPLIANCE	158
13	LIMITED WARRANTY	160

1 INTRODUCTION

1.1 Description

The Explorer Plus series balance offers a premium weighing performance, compliance support and data traceability. The advanced features take the EXP to the next level by optimizing the user experience. This Flagship balance is crafted to meet the most demanding requirements of modern scientific research.

The Explorer Balance is a highly accurate weighing balance, with proper care, it can offer over a decade of reliable service. It comes in various capacities, ranging from 120 grams to 65 kilograms.

1.2 Features

1.2.1 Display

The 7-inch display features vibrant colors and a glass panel that is easy to clean and protection chemical spills.

1.2.2 Modular Design

The balances are composed of two interconnected modules: a Terminal and a Base. Detachable Terminal and Base design ready to use for small lab cabinet or fume hood.

1.2.3 Digital Loadcell with Advanced Environmental Sensors

The balances feature the digital load cell platform with three ambient sensors, which are loadcell temperature, humidity, and air pressure.

1.2.4 Removable Draftshield Design

Removable Draftshield for hassle-free cleaning and long-term care

1.2.5 Motorized Leveling System

The balances feature a Motorized leveling system equipped with a digital-level bubble.

1.2.6 Automatic Draftshield Doors

Enhanced Anti-pinch safety protection with IR sensor operation for easy sample access and prevents hand injuries.

1.2.7 Status Lights and Sample Spotlights

Status lights for weighing visually indicate overload or underload behavior during the weighing process.

Sample spotlight for enhanced visibility and make a Clearview environment

1.2.8 HID Data Transfer Function

Support for HID (Human Interface Device) connection to a computer without the need for drivers

1.2.9 Time Synchronization NTP (Network Time Protocol)

The NTP function enables users to synchronize the time for weighing data across the local network, ensuring consistency.

1.2.10 Fingerprint login System (Accessory)

The fingerprint login system offers a convenient and secure way to log in, eliminating the risk of forgetting passwords or unauthorized password leaks. These measures safeguard the weighing data and the defined weighing process configurations, preventing them from being altered or deleted. Reset the fingerprint internal memory in the Factory Reset menu.

2 Safety Precautions

2.1 Intended Use

This instrument is intended for use in laboratories, pharmacies, schools, businesses and light industry. It must only be used for measuring the parameters described in these operating instructions. Any other type of use and operation beyond the limits of technical specifications, without written consent from OHAUS, is considered as not intended. This instrument complies with current industry standards and the recognized safety regulations; however, it can constitute a hazard in use. If the instrument is not used according to these operating instructions, the intended protection provided by the instrument may be impaired.

2.2 Definition of Signal Warnings and Symbols

Safety notes are marked with signal words and warning symbols. These show safety issues and warnings. Ignoring the safety notes may lead to personal injury, damage to the instrument, malfunctions and false results.

WARNING	For a hazardous situation with medium risk, possibly resulting in severe injuries or death if not avoided.
CAUTION	For a hazardous situation with low risk, resulting in damage to the device or the property or in loss of data, or minor or medium injuries if not avoided.
ATTENTION	For important information about the product. May lead to equipment damage if not avoided.
NOTE	For useful information about the product.

Warning Symbols



General hazard



Explosion hazard



Electrical shock hazard

2.3 Safety Notes



CAUTION: Read all safety warnings before installing, making connections, or servicing this equipment. Failure to comply with these warnings could result in personal injury and/or property damage. Retain all instructions for future reference.

- Before connecting power, verify that the AC adapter's input voltage range and plug type are compatible with the local AC mains power supply.
- Only connect the power cord to a compatible grounded electrical outlet. (For Explorer Plus High-Capacity models only)
- Do not position the equipment such that it is difficult to reach the power connection.
- Make sure that the power cord does not pose a potential obstacle or tripping hazard.
- Operate the equipment only under ambient conditions specified in these instructions.
- This equipment is for indoor use only.
- Do not operate the equipment in wet, hazardous or unstable environments.
- Do not allow liquids to enter the equipment.
- Do not load the equipment above its rated capacity.
- Do not drop loads on the platform.
- Do not place the equipment upside down on the platform.
- Use only approved accessories and peripherals.

- Disconnect the equipment from the power supply when cleaning.
- Service should only be performed by authorized personnel.
- When shipping or transporting this product, follow the applicable regulations for equipment containing lithium-ion batteries.
-



WARNING: Never work in an environment subject to explosion hazards! The housing of the instrument is not gas tight. (Explosion hazard due to spark formation, corrosion caused by the ingress of gases).



WARNING: Electrical shock hazards exist within the housing! The housing should only be opened by authorized and qualified personnel. Remove all power connections to the unit before opening.



CAUTION: The protection provided by the unit may be impaired if used with accessories not provided or recommended by the manufacturer, or used in a manner not specified by the manufacturer.



WARNING: ELECTRICAL SHOCK HAZARD

Avoid pressing two carbon brushes while the lonizer is turned on.

3 Installation

3.1 Unpacking

Carefully unpack the Explorer Plus balance and its components. The components included may vary based on the balance model. Retain the packaging for safe storage and transportation.

- Balance
- Quick Start Guide
- Weighing Pan
- Power Adapter and Local Electronic Plug (except High-Capacity Models)

3.2 Installing Components

The Explorer Plus balance is designed for quick, no-assembly installation, allowing for immediate use.

Simply follow the steps to assemble your Explorer Plus balance within seconds.

Assembly of all components is required before using the balance.

3.2.1 For 0.01mg, 0.1mg, and 1mg Models

Unpack the balance and install the weighing pan.



3.2.2 For 0.01g, and 0.1g Models

Unpack the balance and install the weighing pan.



3.2.3 For High-Capacity Models

Unpack the balance and install the weighing pan.

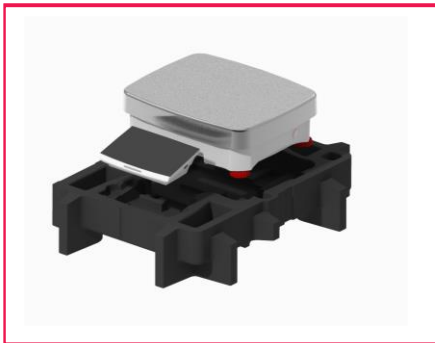
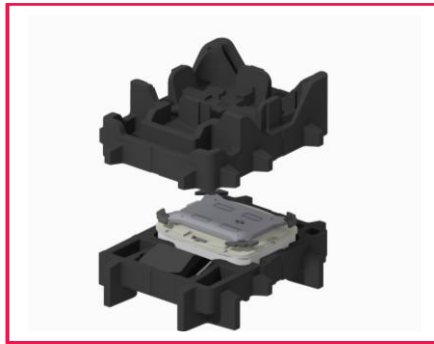
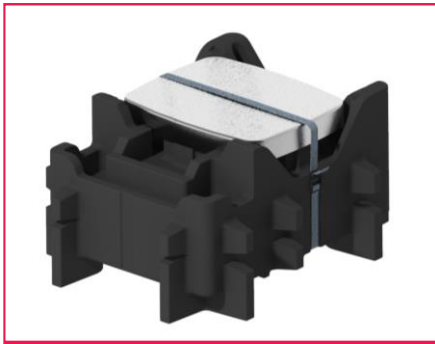

3.2.4 Selecting a Location

External factors such as temperature fluctuations, air currents, electromagnetic interference, and vibrations can all have an impact on the accuracy of the analytical balance. It is important to keep the analytical balance in a controlled environment to minimize these factors and ensure accurate readings.

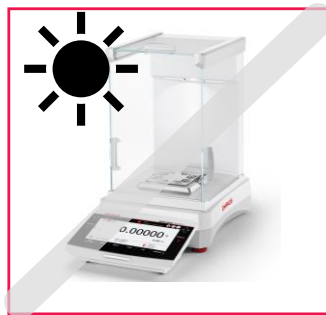

3.3 Connecting Power

- For Analytical and Precision models supplied with an AC adapter, connect the DC output connector to the power receptacle on the rear of the base. Then connect the AC power cord to a suitable electrical outlet.
- For High-Capacity models, you need to connect the power cord to a suitable electrical grounded outlet.



Caution:

- For use with CSA certified (or equivalent approved) power source, which must have a limited current output.
- Allow equipment to warm up for 60 minutes for optimal weighing performance.

3.4 Turn on the balance

- Short press the power button to turn on the balance.



- Login the balance with default USERNAME AND PASSWORD.
 - USER ID: Admin
 - PASSWORD: No password required





- When the balance run in sleep or standby or mode, press the **LABMAN** icon to start weighing.

3.5 Adjust the viewing angles

To adjust the display's angle, hold the base of the terminal and move it upward or downward. The internal connection cable has a maximum length of 1 meter.



3.5.1 Level the Balance Before Use

The Explorer Plus analytical and precision models are equipped with a motorized leveling system and a digital level bubble. To level your Explorer Plus balance, simply follow the provided steps. The digital level indicator will notify you if the weighing table is not level. The Explorer Plus high-capacity model also features a built-in digital level bubble, but it has slightly different leveling steps.

The balance uses a built-in Motorized Leveling program to level the balance automatically.

- Go to the main screen and find the Motorized Levelling button at the left corner, press it to start leveling the balance.
- The process is fully automated and does not need any user operation during the levelling.
- If the environment is unstable or the weighing table is tilting too much, the leveling process may fail. In such cases, you need to move the balance to a stable, level surface that can absorb vibrations.

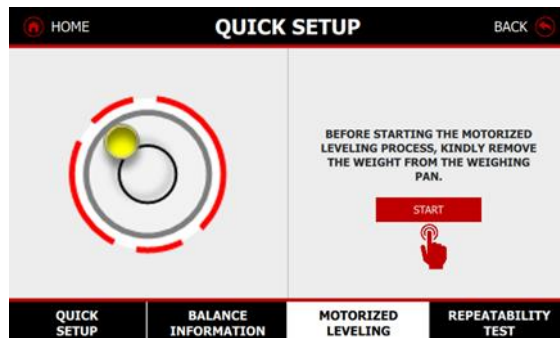
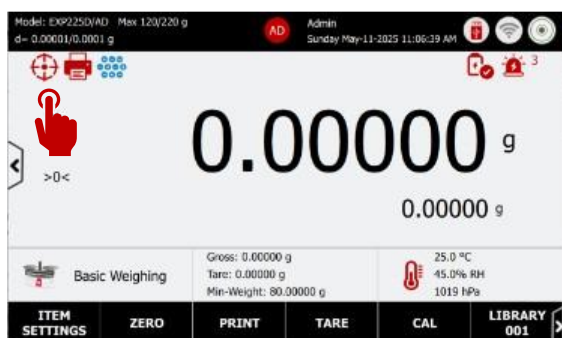

- For Explorer high-capacity Model, press the leveling button, and adjust the leveling feet according to the position of the digital bubble until the bubble is centered.

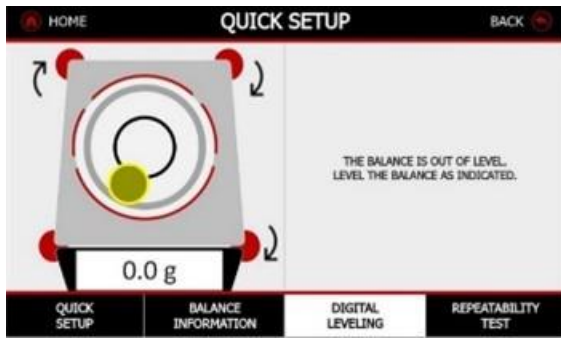

3.6 Disconnect the terminal from the weighing base

- To remove the terminal from the base, simply lift the terminal straight up.
- To reattach the terminal, align the connection rods with the slots on the base frame and insert them.
- If you need a longer operating distance, the terminal extension cable and tower kit are available as optional accessories. Refer to the accessory list in section 11.5.



3.7 Remove Draftshield from the Base

- Remove the weighing pan and unlock the draft shield fixed ring.

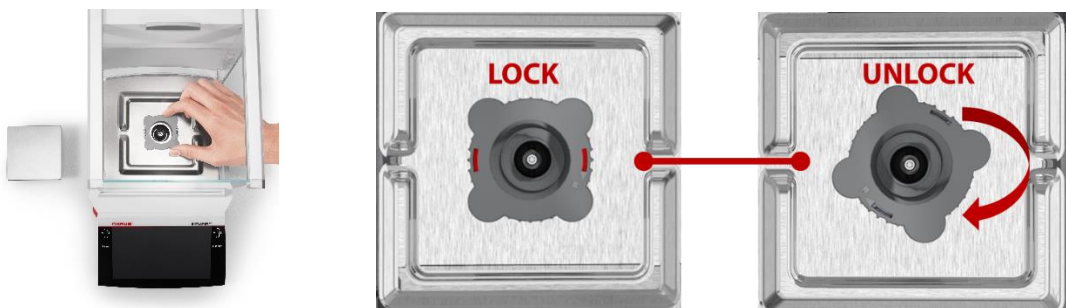

- Remove the EMC plate and take out the 4 screws beneath it. Raise the draft shield vertically.



3.8 Connecting the Interface

Enhanced communication options include 2 USB Host (Type A) x 2, USB Device (Type B) x 1, USB Device (Type C) x 1, Ethernet Lan port (RJ45) x 1, RS232 x 1; Optional Wi-Fi, Bluetooth Dongle.

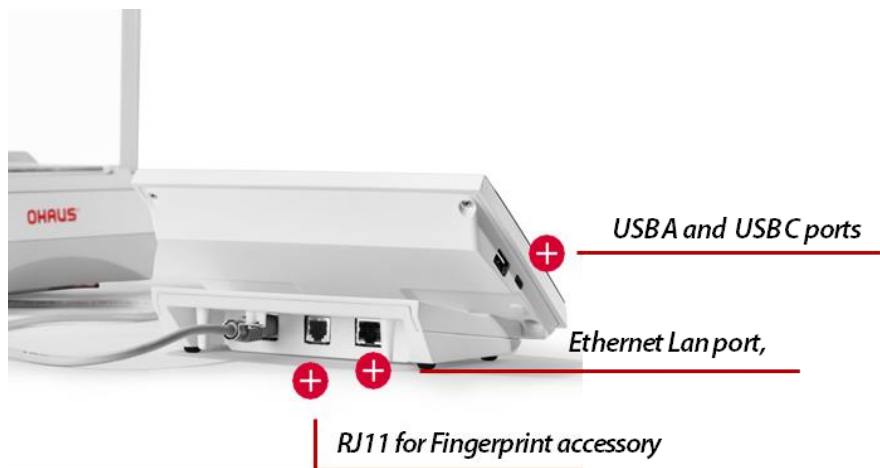

3.9 Install the rechargeable battery for High-Capacity Models

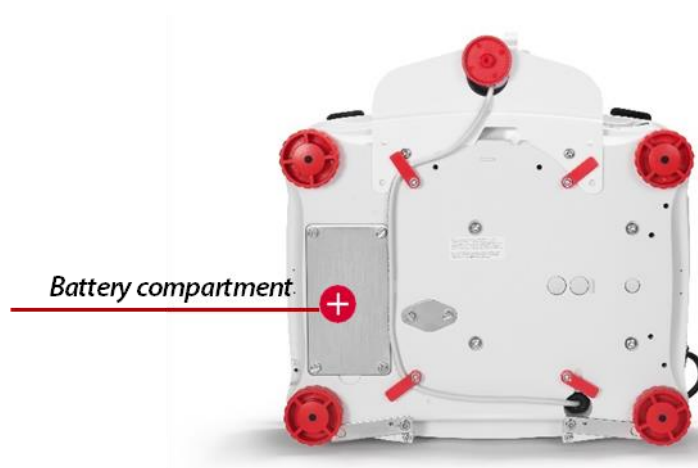

Follow the following steps to properly install the rechargeable battery:

- Remove Battery Cover
 - Unscrew the 4 screws securing the battery cover.
- Connect Charging Cable
 - Battery charging flex cable inserted into the battery interface and engage with two locking buckles.

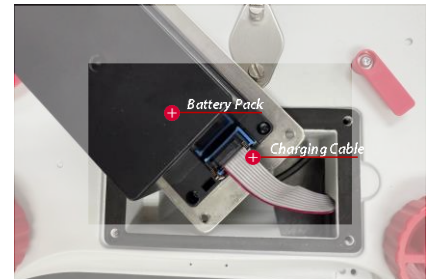
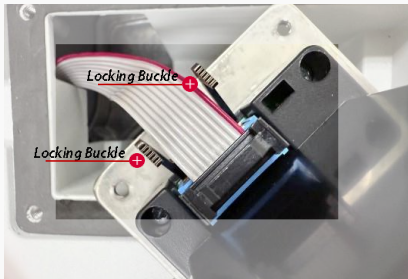
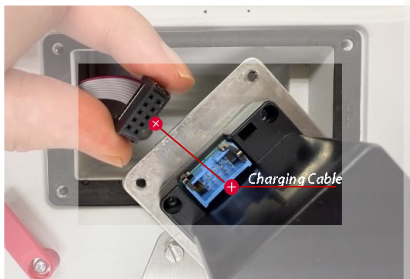

- Reinstall Battery and Secure the Cover
 - Place the battery back into its slot.
 - Tighten the 4 screws to lock the battery cover in place.



3.10 Overview of Parts and Features –Draft Shield Models

3.10.1 Side View

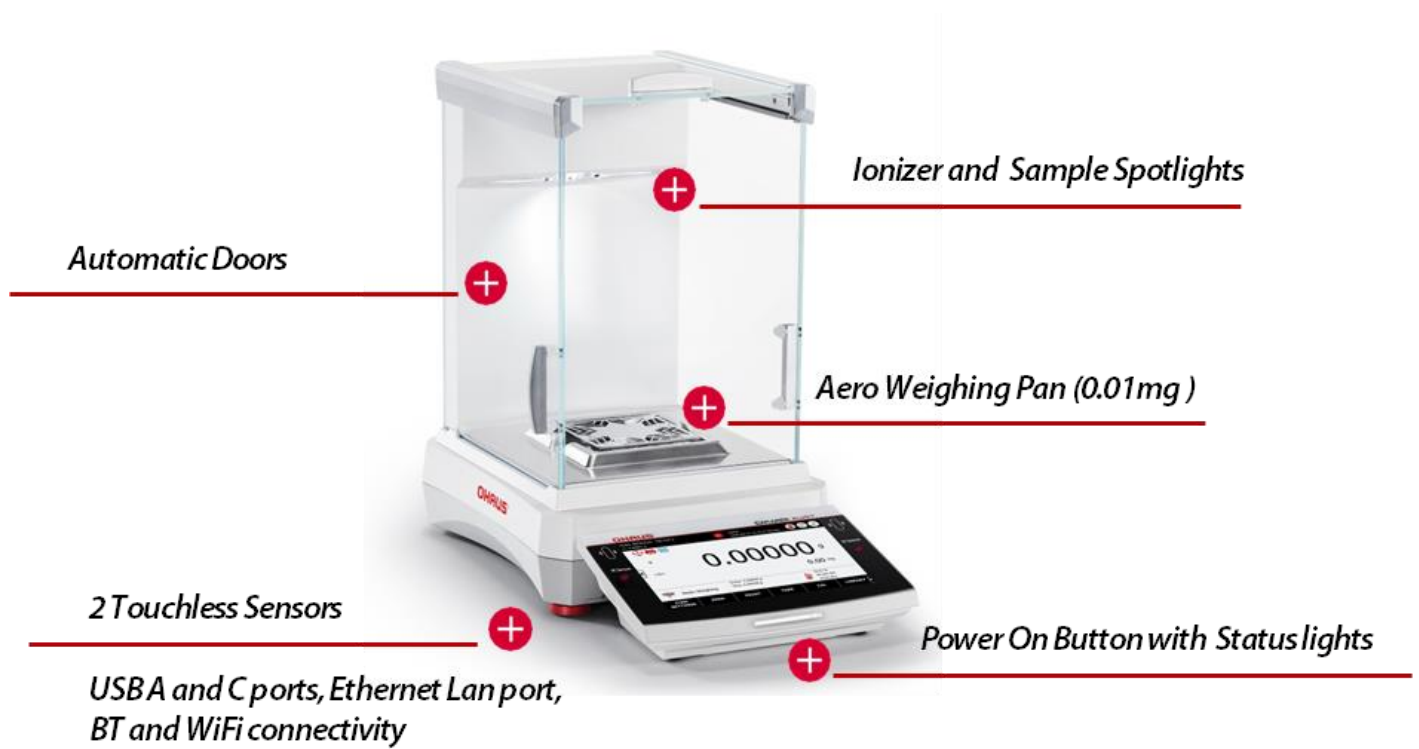

3.10.2 Rear View



3.10.3 Weigh Below Hook

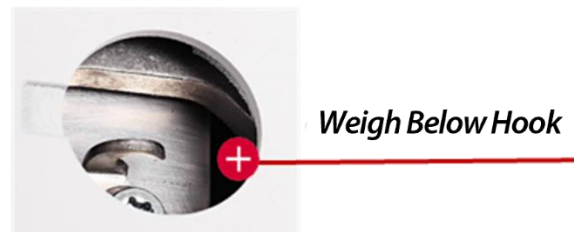
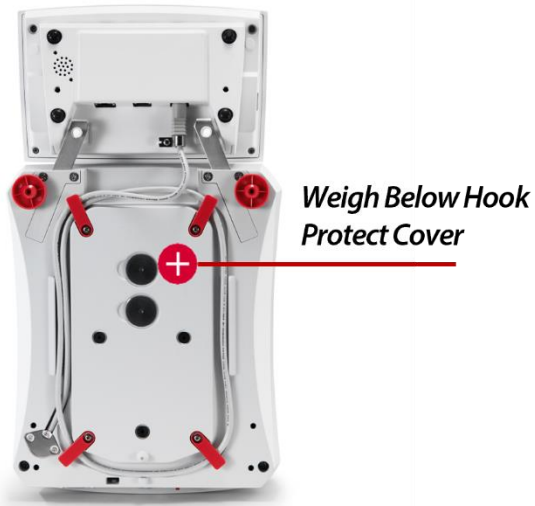

3.11 Overview of Parts and Features –Non-Draft Shield Models

3.11.1 Side View



3.11.2 Rear View



3.12 Overview of High-Capacity Models

3.12.1 Side View



3.12.2 Rear View



3.13 Terminal Overview

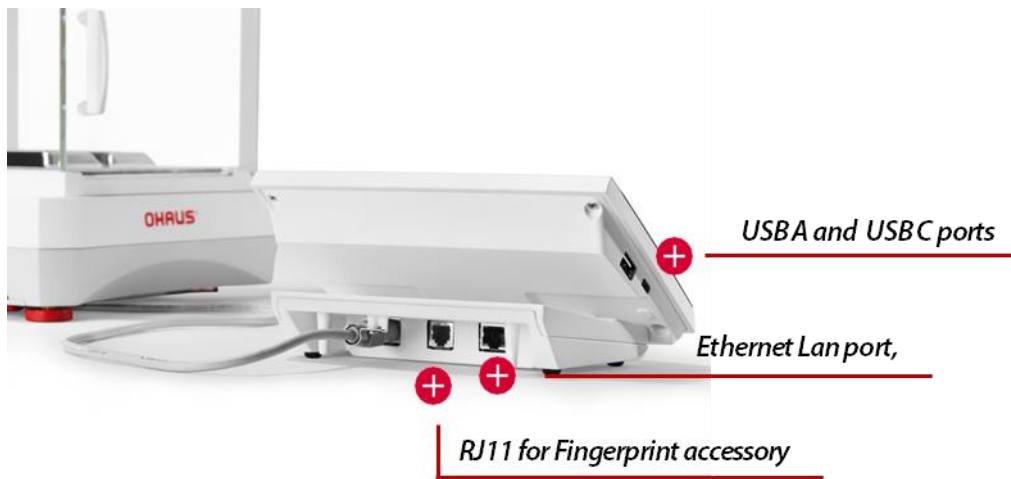
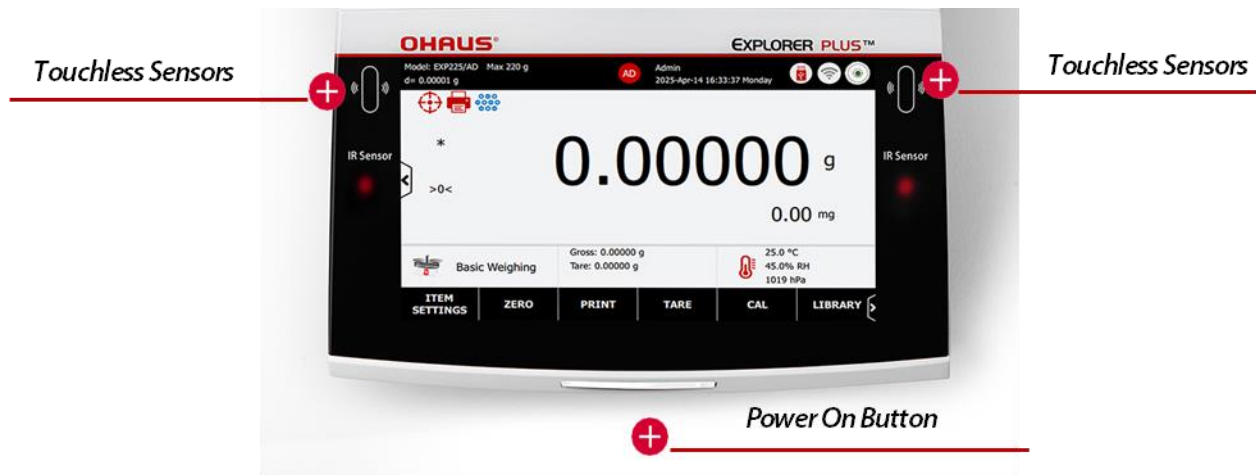

3.14 Main Screen Features

This Explorer Plus balance has built a 7-inch display features vibrant colors and a glass panel that is easy to clean and provides protection from chemical spills.

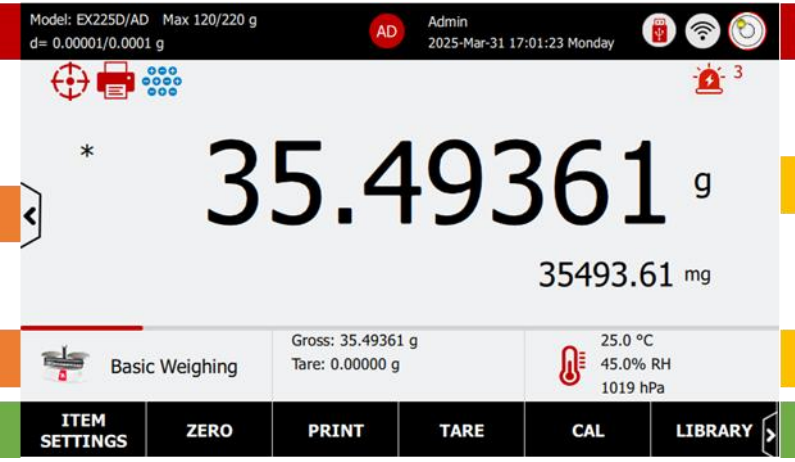
<p>Upper Left (Shortcut buttons)</p> <ul style="list-style-type: none"> ✓ Motorized Leveling ✓ Batch Print ✓ Ionizer 	<p>Top Line</p> <ul style="list-style-type: none"> ✓ Display the essential balance information, such as model name, the max capacity, d value and e value. ✓ User Name and Date/Time 	<p>Upper Right</p> <ul style="list-style-type: none"> ✓ Peripherals Icons connected to balance ✓ Real time leveling bubble ✓ Warning Sign
<p>Press the trapezoidal key to switch between main menus.</p> <ul style="list-style-type: none"> ✓ Quick Setup ✓ Calibration ✓ Balance Setup ✓ User Management ✓ Application Modes ✓ Weighing Units ✓ Communication ✓ Library ✓ Maintenance ✓ Factory Reset ✓ Log Off ✓ Power Off 		<p>Main Display Area</p> <ul style="list-style-type: none"> ✓ Click “g” to switch an alternative unit ✓ Display the parameter for the current application on the reference field ✓ Digital loadcell Environmental Sensors
<p>Press the “Basic Weighing” key to switch weighing application modes</p>	<p>Hotkeys</p> <ul style="list-style-type: none"> ✓ Item Settings, Zero, Print, Tare, Calibration, Library/Method, Sensors, and press “ADD+” key to add customized hotkeys 	<p>ADD+</p> <ul style="list-style-type: none"> ✓ 1d/10, Left Door, Right Door Open, Motorized Leveling, Repeatability Test

3.15 Warning and Notifications

The Explorer Plus balance features an internal warning and notification system that alerts users to take action in the following circumstances:

- Calibration failure: The balance has not calibrated successfully.
- Leveling required: The balance needs to be leveled when the digital level bubble is not centered.
- Password expiration: The password has expired in accordance with the password policy.
- Battery Indicator: The high-capacity balance uses battery when the power cable is not connected.
 - The percentage of battery life will be displayed at the right corner of the main screen.
 - When the battery power is low, a battery warning sign will appear. It is recommended to connect the power supply within 30 minutes. Failure to do so may cause the balance display to shut down and result in the loss of weighing data.

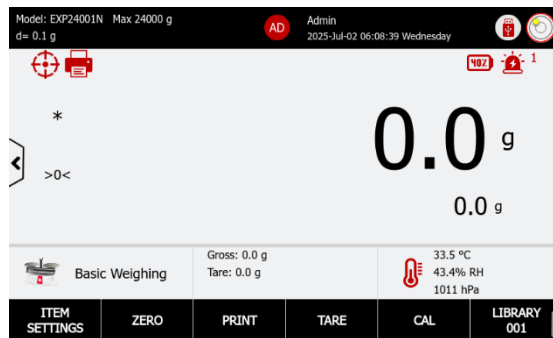
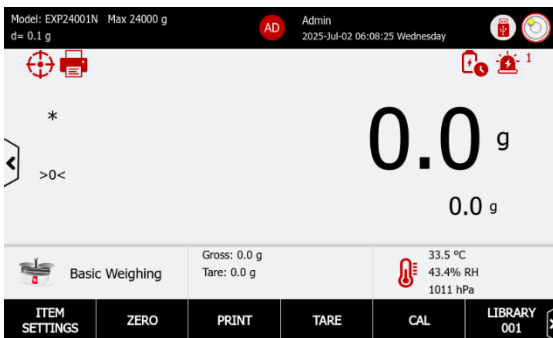

3.15.1 Calibration Failure

- Press on the warning sign, and the notification will show up on the screen, press the message, you will find “Calibration” key.

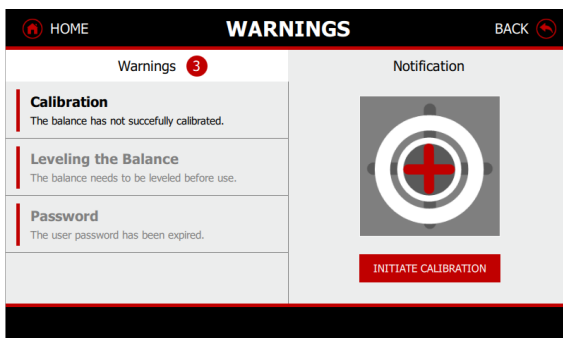

- Perform internal calibration or span calibration. For details, please refer to 5.4 Calibration.

3.15.2 Leveling Required

- Press on the warning sign, and the notification will show up on the screen, press the message, you will find “Leveling” key.

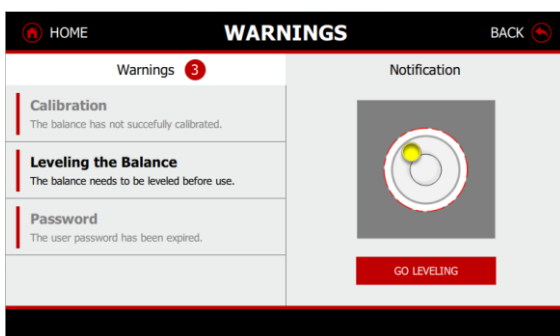

3.15.3 Password Expiration

Press on the warning sign, and the notification will show up on the screen, press the message, you will find “Reset Password” key.

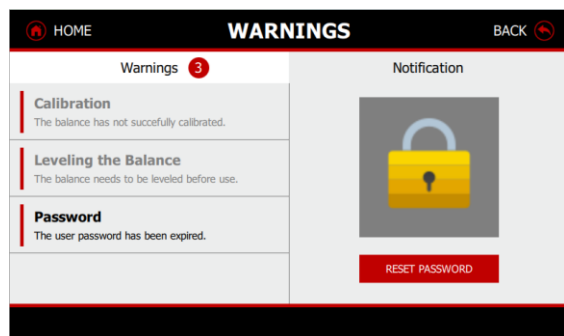

Note: If you forget your password, please contact Ohaus or your local Ohaus dealer for assistance.

3.16 Hotkeys

At the bottom of the main screen, there are eight hotkeys for basic weighing applications. Users can customize an additional five hotkeys by using the ADD+ feature.

3.16.1 Standard Hotkeys

Hotkeys	Description
Item Settings	Press to configure current application mode settings.
Zero	Remove the load from the pan and press Zero to set the display to zero. When weighing pan is empty, the >0< indicator turns on when the measurement is within $\pm \frac{1}{4}$ division (d) of the zero setting. Note: The balance also features Auto Zero Tracking (AZT) that automatically maintains a Center of Zero within the tolerances set in the AZT menu (see Balance Setup).
Print	Press Print to send the displayed value to a printer or computer via the active COM port. Make sure that the balance has connected with printer or PC and interface parameters are set up correctly.
Tare	Tare key is to tare the weight on the container to zero, and the net weight will show on the reference field
CAL	Press CAL to calibrate the balance or to set the calibration parameters.
Library	Press "Library" key to either create a new library or retrieve an existing one for the current application.

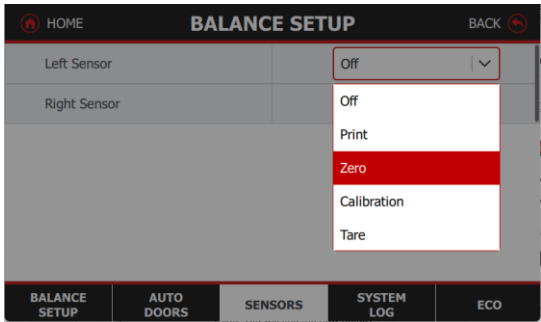
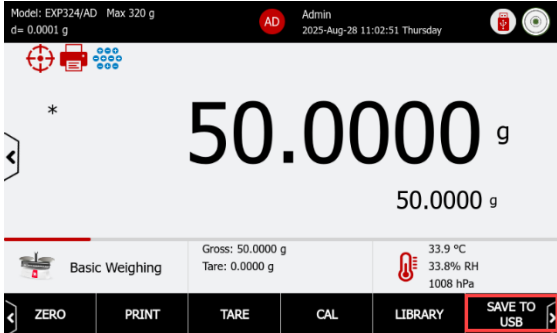
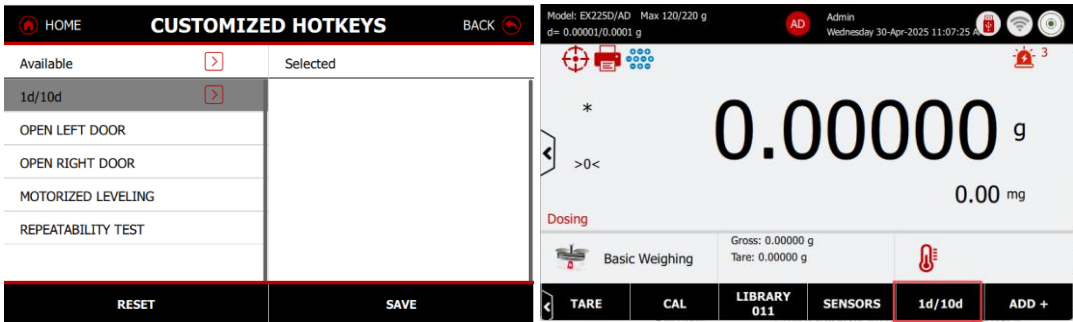
<p>Sensors</p>	<p>The balances have two pressless sensors that can be assigned a unique function when activated. The Sensor setting are: Off, Print, Zero, Calibration, Tare, Auto Doors, Open Left Door, Open Right Door, Ionizer, Ionizer + Tare, and Sample spotlight.</p>  <p>Once the sensor is set up for a specific function, waving your hand over it will trigger that function and cause the sensor light to turn green. If the sensor fails to activate, verify the settings. The sensor lights will remain red.</p>
<p>Save to USB</p>	<p>When the user inserts the USB flash drive, an icon will appear on the right side of the Sensor. While data is being saved to the USB drive, the icon will display the progress.</p> <p>Do not unplug the USB drive during data transfer.</p> 
<p>Add+</p>	<p>Additional five hotkeys be customized.</p> <p>Click "Right Arrow" key to move the available hotkey to selected area and press "Save" to exit.</p> <p>The new hotkey will appear on the right side of the "Sensor" section. Swipe along the bottom line, you will find the new hotkey.</p> 

3.16.2 Additional Hotkeys (Add+)

1d /10d	Press 1/10 to change 1d or 10d division for weighing result
Motorized Leveling	Press to Motorized Leveling the balance
Repeatability Test	Press Repeatability Test to perform repeatability test
Left Door Open	Open the draftshield left door
Right Door Open	Open the draftshield right door

3.17 Shortcut Buttons

The shortcut buttons are available only in Basic Weighing application. For details, please refer to shortcut button in section of 4.2.9

3.18 Digital loadcell Environmental Sensors

Enhanced digital load cell platform with three ambient sensors: loadcell temperature, humidity, and air pressure.

Note: Ambient sensors are active only in basic weighing mode. Tap the field to view details; tap again to hide.

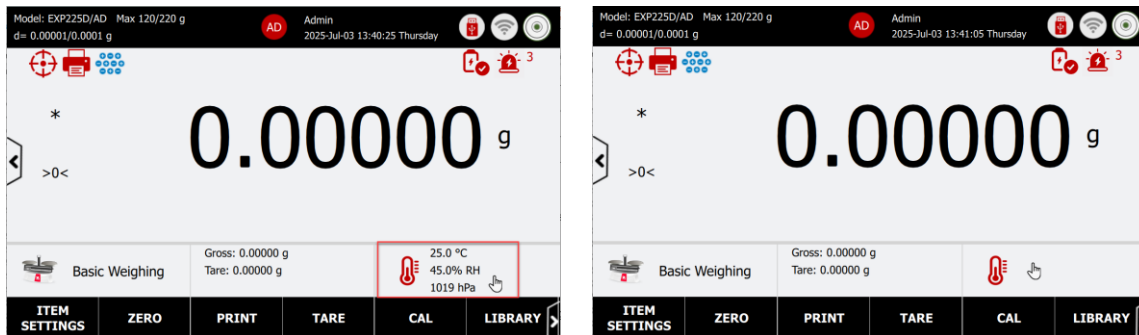

3.19 HID Connections

The Explorer Plus balance supports HID (Human Interface Device) connection to a computer without needing drivers. This allows users to use a mouse or keyboard to enter information such as User Name, USER ID, sample name, batch name, and other input details. The input field supports both English and French characters, as well as numbers, and symbols.

3.19.1 English Keyboard

- English keyboard is default setting, click “Upward arrow” key, you will find the lower-case letter and additional symbol such as @, %, -, ^ and etc.
- Repeat three times, and you can find all the characters you need to input.
- The currently selected language is displayed on the SPACE key.

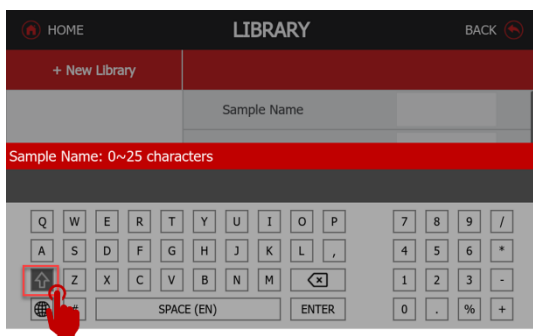

Uppercase Letter/ Numeric Input

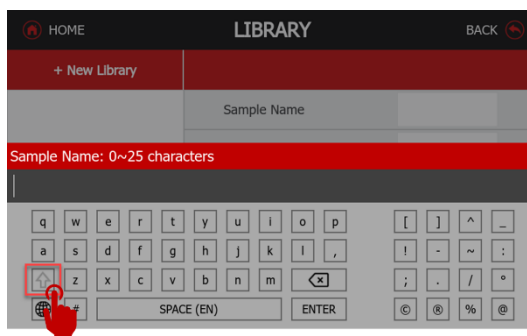

Lowercase Letter/ Symbol Input

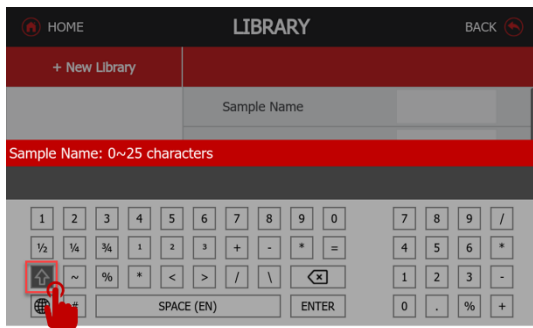

Numeric/ Symbol Input

3.19.2 French Keyboard

- Click “Earth” key, the keyboard changes to French language.
- Press the Upward arrow to access French characters, as well as symbols like %, 1/2, 1/4, 3/4, √ 2, ³3, ml, and more.
- Repeat three times, and you can find all the characters you need to input.
- The currently selected language is displayed on the SPACE key.

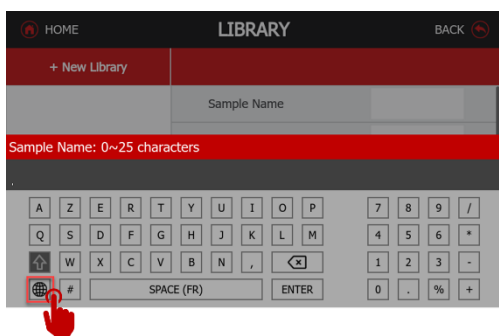

Uppercase Letter/ Numeric Input

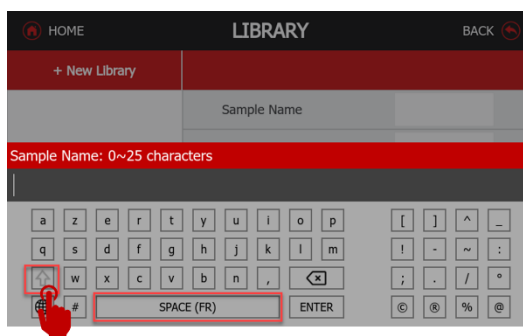

Lowercase Letter/ Symbol Input

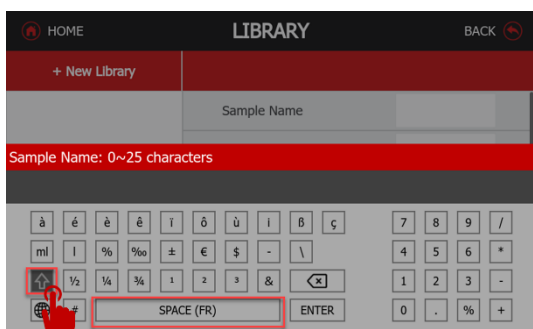

French character/ Number Input

4 Weighing Application Modes

4.1 Introduction

The Explorer Plus balance has 15 weighing application modes. All applications are by default enabled. You can disable the weighing application modes in Menu/Application Modes. Before using any weighing application, ensure that the balance has been leveled and calibrated successfully.

The application mode switch button is located in the lower left corner. Press the “Basic Weighing” key to switch weighing application modes.

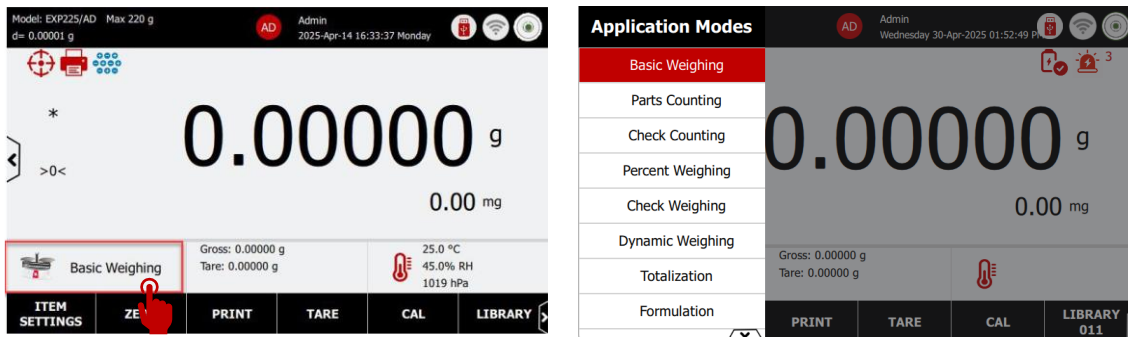

- **The Basic Weighing** application is used to determine the weight of items in the selected unit of measure.
- **Parts Counting** displays the number of pieces or parts based on an average piece weight. Checks if the current sample pieces are within tolerances (e.g. an over and under limit).
- **Check Counting** checks if the current sample pieces are within tolerances (e.g. an over and under limit).
- **Percent Weighing** displays the current weight as a percentage of a reference weight.
- **Check Weighing** checks if the current weight is within tolerances (e.g. an over and under limit).
- **Dynamic Weighing** is set to weigh objects that are not stable, such as animals.
- **Totalization** is used to sum the weights of multiple samples and report the statistical data for the series of samples.
- **Formulation** is used to combine various elements in proportionate amounts.
- **Differential** is used to calculate the difference in weights of multiple samples taken at different times.
- **Density Determination** is used to determine the density of a solid or a liquid.
- **Peak Hold** captures the maximum weight in a series of weighing.
- **Pipette Adjustment** calculates the inaccuracy and imprecision of pipettes, used to check if a pipette's dosage is within tolerances.
- **SQC** is used to determine the homogeneity of items in a batch and batches over time.
- **Fill Weight Variation** is to assess the uniformity of the weight of material dispensed into a container or mold throughout the manufacturing process.
- **Flow Rate Control** aims at managing the volume or mass of fluid (liquid or gas) that passes through a pump system over a specific period.

4.2 Basic Weighing

- Basic weighing application modes are displayed by default on the main screen.
- Press **Tare** or **Zero** to start weighing.
- Place sample on the pan to display the weight. When stable, the * appears.
- The resulting value is displayed in the main Weighing Line in the active unit of measure.

4.2.1 Weighing Result

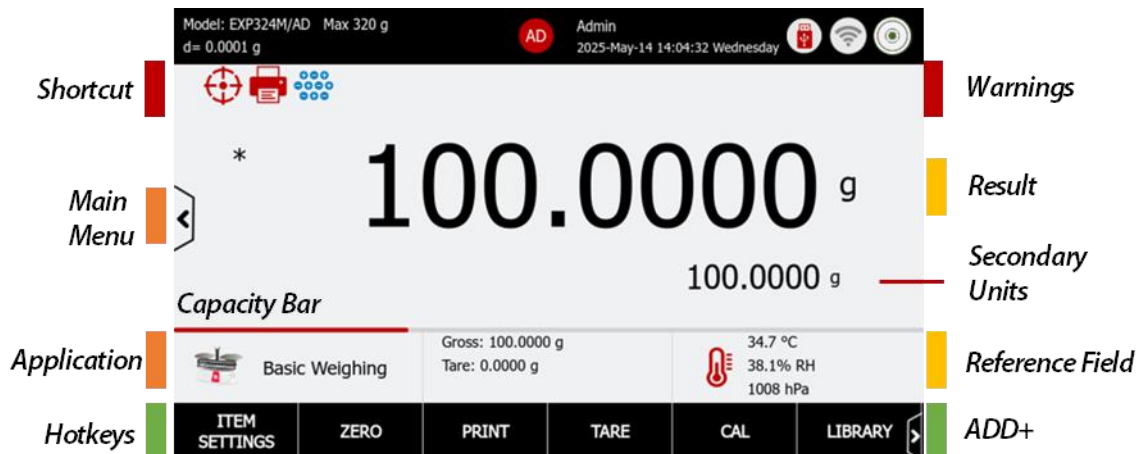

4.2.2 Reference Fields – Basic Weighing

Reference Fields	Description
Gross/ Tare	Display the Gross weight and tare value when the container is tared
Min Weight (Conditional)	When the Minimum Weight is set to On or Below Minimum Weight. Display the minimum weight value.
Environmental Sensor	Load cell temperature, humidity and air pressure. Default setting is on. Click off to hide this field.
Capacity Bar	The red line represents the current load as a proportion of the balance maximum capacity.
Item Settings	<ul style="list-style-type: none"> • Primary Weighing Unit: The default unit is grams. The operator can switch to alternative weighing units and two custom units. • Secondary Weighing Unit: able to alternative weighing units and 2 custom units • Weighing Mode: Standard, ip Mode <ul style="list-style-type: none"> ■ Sample Dosing Mode is design for powder sample, or any sample are sensitive to be stable • Minimum Weighing • Auto Tare: Automatic tare the container value

4.2.3 Item Setting

Press the ITEM SETTINGS button to change the application settings.

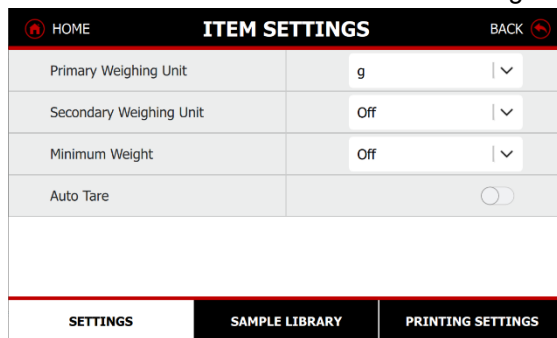

Primary Weighing Unit/ Secondary Weighing Unit

- Click “g” to switch an alternative primary weighing unit. The default unit is gram.
- Select a secondary unit to display below the primary line.

Switch to alternative Unit

Click “g” to switch an alternative unit

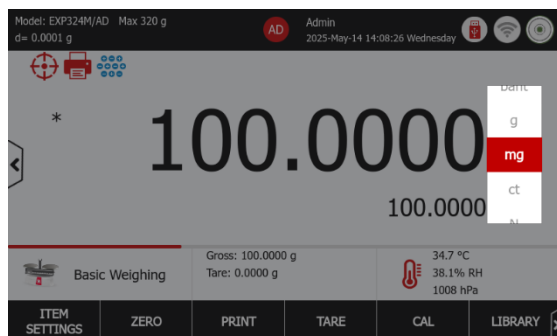

4.2.4 Minimum Weight

Determining the minimum weight in laboratories is crucial for ensuring accurate and reliable weighing results. The Explorer balance has a minimum weight function that the user can manually enter a required minimum weight. When the weight placed on the balance is below the minimum weight indicated in the settings, the screen will indicate Below Minimum Weight. This notifies the operator that more sample material is needed before a result will be displayed.

The Explorer Plus balance offers three options of minimum weight settings: Off, On, and Below Minimum Weight.

- **Off:** Disable function
- **On:** When the result is lower than min-weight, the screen will show “Below Minimum Weight”.
 - The operator had to add more samples. The result will not be printed in paper printouts.
- **Below Minimum Weight:** When the result is lower than min-weight, the screen will show “Below Minimum Weight”. The operator had to add more samples. The result will be printed in paper printouts.

Example: If the minimum weight is set at 10 g and the sample weighs 2.6893 g, the screen will display “Below Minimum Weight.” Once additional sample material is added and the sample weight reaches the minimum weight standard indicated in the settings, the screen will then display the weigh results.

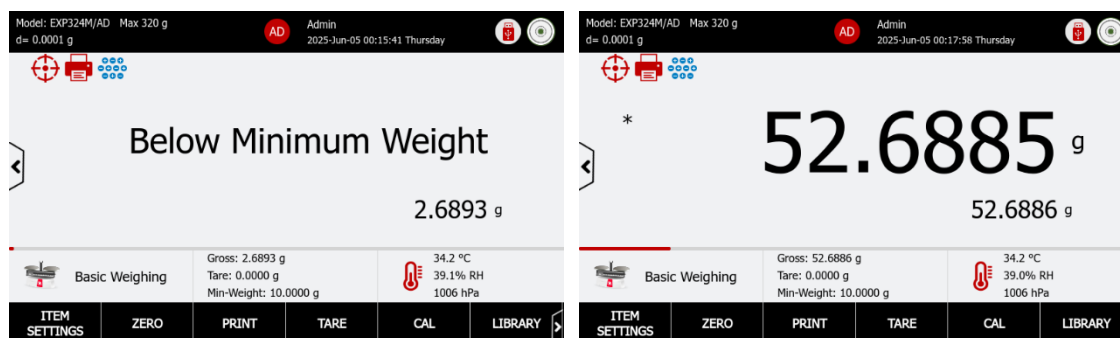

4.2.5 Setting the minimum weight value

- Press the Sample Library tab to input the min-weight value when you turn on the min-weight in settings.
- Input the min-weight value, and the range of minimum weight is from 0g to max capacity. If the number is out of the range, it will display an error message “invalid entry”.

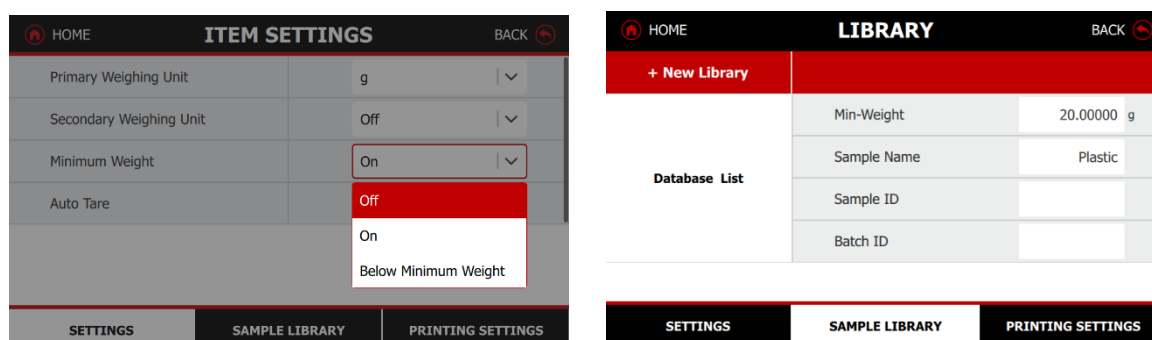

4.2.6 Auto Tare

- Auto tare allows users to tare the container weight
- When Auto Tare is enabled, the screen would display the message “Place container on the pan.”
- After a container is placed on the weighing pan, its weight will be stored in the balance. The net weight and gross weight values will then be displayed in the reference field.

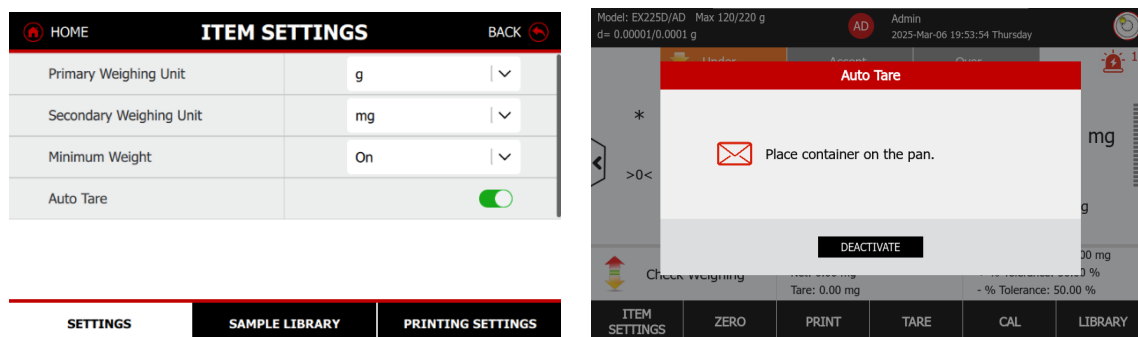

4.2.7 Sample Library

The Explorer Plus balance features a built-in library for managing multiple sample profiles. Up to 3,000 library records can be saved and recalled for use. The total library capacity and records are accessible across various application modes and through the library menu. When the library usage exceeds 80%, a pop-up message will alert the user to export the library or delete all items. The entire library menu, please refer to the section of Library.

Create, Activate and Delete a Library

- Press “+New Library” button to create a new Library.
- When a new library is created, it remains inactive. The operator has to activate the library after ticking the box.
- Press on the RUBISH BIN button to delete a library.
- After the library item is activated, the main screen will show the activated library number.
- Other sample information can be configured in the library, including sample name, sample ID, batch ID, lot ID, project ID, and the creation of 10 more customized ID.

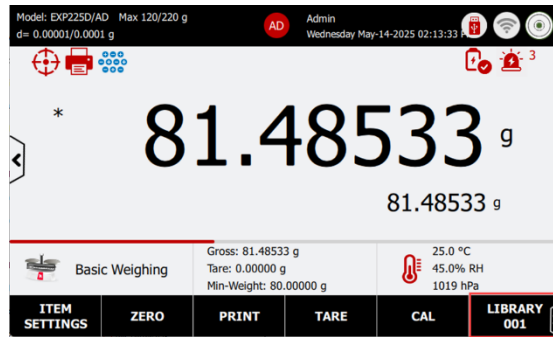
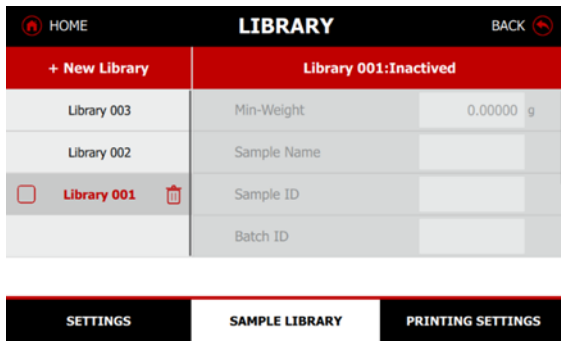

4.2.8 Print Settings

The Explorer Plus balance offers advanced print settings. Users can customize the output format and content and direct it to Excel or save it in a USB-compatible format. Additionally, users can review the print content to ensure all items are correctly selected before printing on paper or PC.

For details of Print Settings, please refer to section 6.0.

4.2.9 Shortcut Buttons

The Explorer Plus balance offers three shortcut buttons for easy leveling, print batch sample result, and turn on lonizer function.

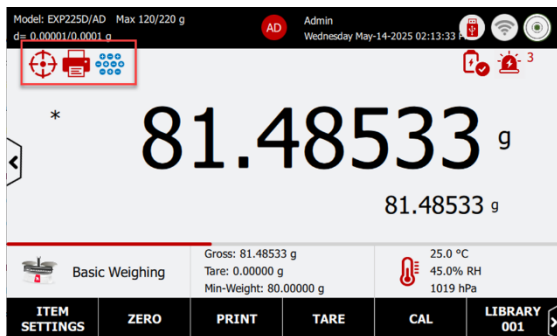

Motorized Leveling

Press the Motorized Leveling icon to initiate the automatic leveling of the balance. The initial digital level bubble will display the real-time status at the upper right corner. Refer to Section 5.3.8 for detailed information on motorized leveling.

Batch Printing

Batch Printing enables users to record and print a list of sample weights, with the capacity to handle up to 999 sample units in a single batch. This feature is exclusive to the Basic Weighing application.

- Press the button to start measure batch samples. The batch sample information will show on the left side of screen. The right side of screen shows the current sample result.
- Place a sample onto the weighing pan, press accept when the weight is stable.
- Press “End Batch” button to complete the sample batch weighing, then the operator can print all the batch weighing data at once.
- Before printing, the user can go back to edit when the result has errors.
- User can export the data to PDF or print to PC/ Printer. After printing, operator can review the history result

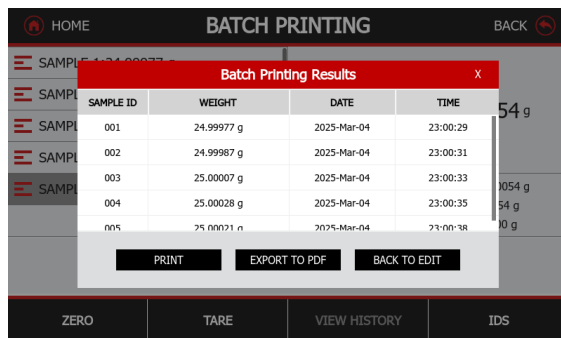
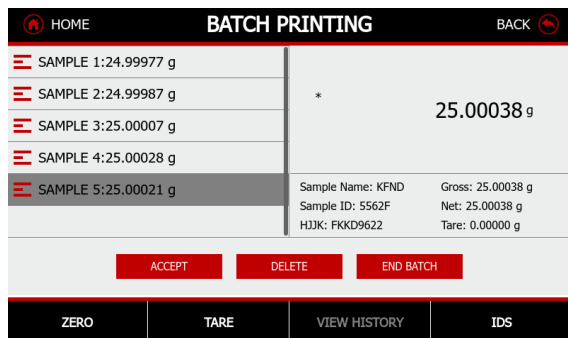

Notes:

- The batch printing value can start from 0 g in the batch weighing process.
- If users would like to continue with batch printing, tap "BACK TO EDIT" to exit the result screen. The result will neither be printed nor saved to the history.

Ionizer

Press the Ionizer icon to use Electrode brush to neutralize the weighing chamber. Refer to Section 5.5.12 for detailed information on Ionizer.

4.3 Parts Counting

- Use this application to count samples of uniform weight.
- In the lower portion of the home screen, select Parts Counting.
- Press **Tare** or **Zero** to start weighing.
- Place objects on the pan to display the number of pieces. The default (or last) Average Piece Weight (APW) is displayed.
- Setup the SAMPLE SIZE, Average Piece Weight (APW) before starting Parts Counting application.

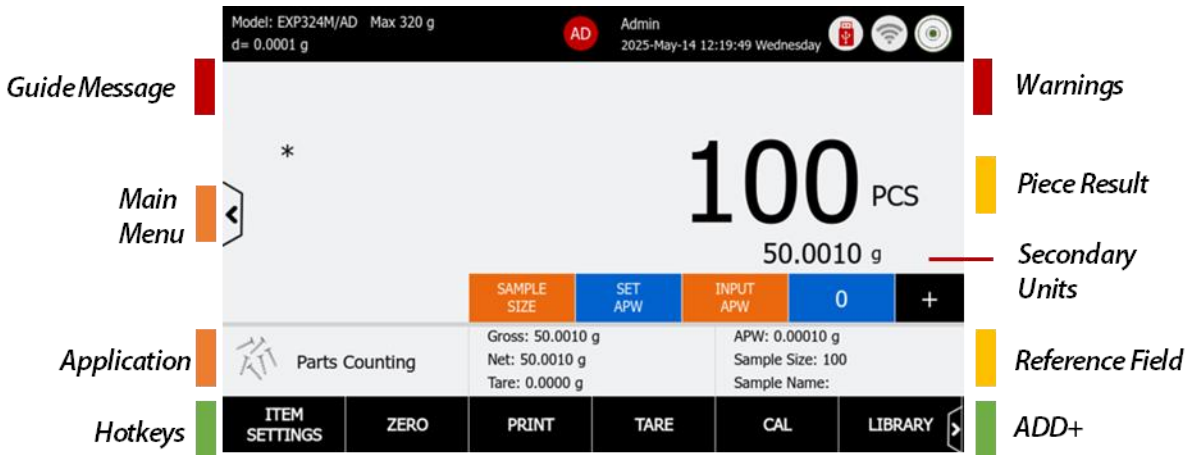

4.3.1 Application buttons

Application Button	Description
Sample Size	Input sample size
Set APW	Place the sample on the pan, the balance will calculate Average Piece Weight (APW)
Input APW	Input Average Piece Weight (APW)
0	The statistic key is to recall the number of parts counting, and press this button, operator can review the statics results.
+	Press this button to manually accumulate weight. In Automatic Statistics mode, this button will be inactive.
Item Settings	<ul style="list-style-type: none"> • Auto Optimization: able to automatically optimized APW Auto Optimization improves counting accuracy. • Statistics: Automatic, Manual • Secondary Weighing Units: able to use 15 weighing units and 2 customer units • Auto Tare: Automatic tare the container value

4.3.2 Begin Parts Counting

Step 1: Establish an Average Piece Weight (APW)

Each time a new type of part is counted, the nominal weight of one piece (Average Piece Weight or APW) must be established using a small quantity of pieces.

Set a Known Average Piece Weight (APW)

- Press the INPUT APW button and enter the desired APW value.
- Tap ENTER to save the value

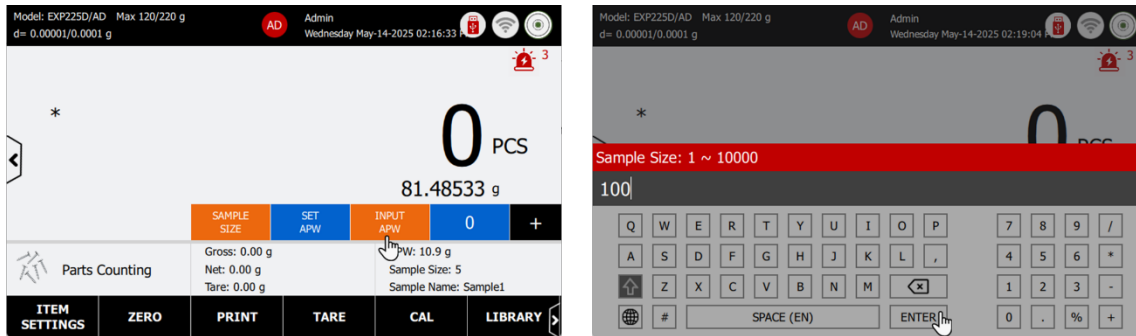

Set a new Average Piece Weight (APW) – Derived

- Press the Sample Size button and enter the desired Sample Size.
- Tap ENTER to save the value
- Place reference weight on the pan, and press Accept to establish a new APW.
- Example: The home screen displays 2.50006 g at the new APW.

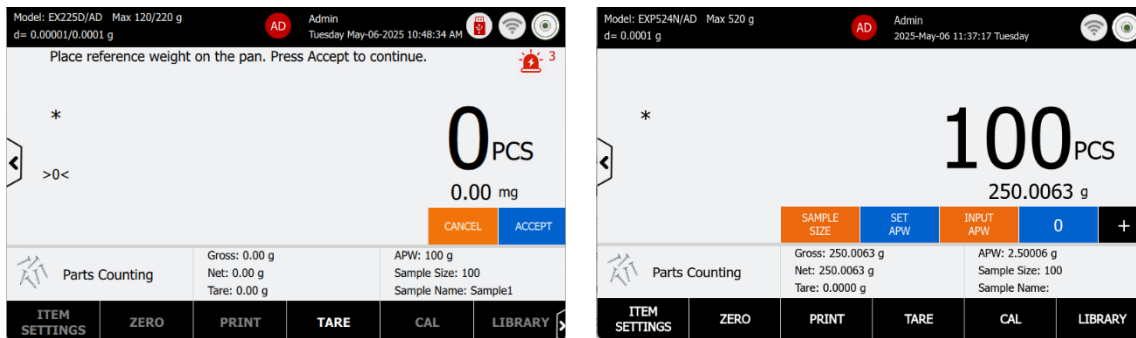

- The sample size can be 1 to 10 000 pieces. The default sample size is 10.
- Once a sample size is changed, the balance will immediately recalculate APW screen, expecting to establish a new APW. The home screen shows 100 pieces at the new APW

Step 2: Counting the Samples

Place samples on the pan, the balance will display the number of pieces.

4.3.3 Accumulate the data for Parts Counting

Utilize the Statistics "+" function to aggregate samples based on counting numbers and generate statistical reports.

The balance can store up to 99 accumulation records.

Step 1: Set the Statistic Mode in Parts Counting Mode

- Statistics can be determined Manual mode or automatically
- Automatic Mode: Weights are automatically recorded when stable
- To use the statistics function, enable it first in the Item Settings.
- Add items and press the "+ Statistic button to accumulate the statistical data
 - Tap the statistics number to view the statistical results.

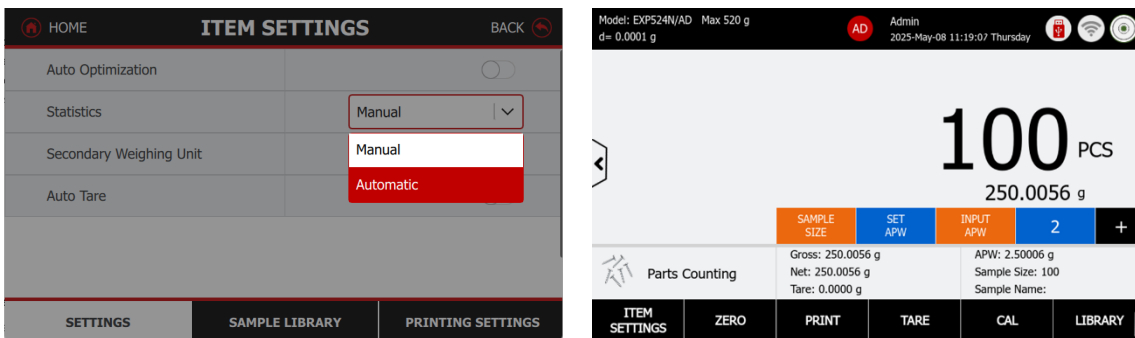

Step 2: Statistics Report View

- The report content includes Start Time, Number of Samples, Total, Average, Maximum, Minimum, Range, Standard Deviation, Relative Deviation % and individual item weighing values.

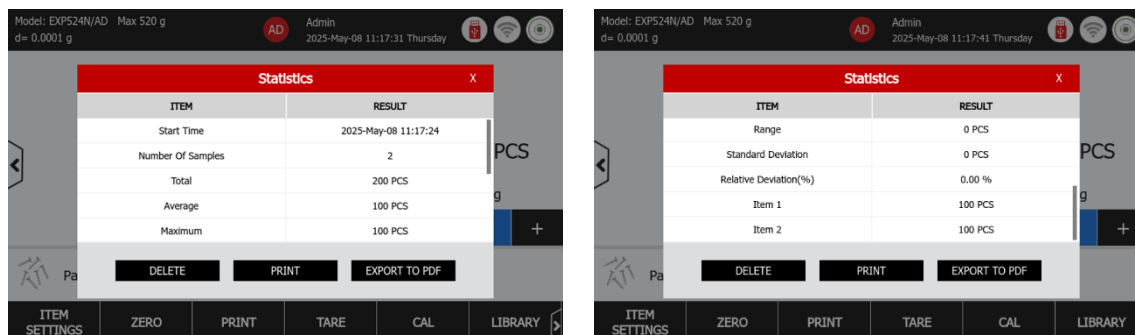

Step 3: Print Report

After reviewing the report, users can choose from several actions:

- Delete the statistics and restart the percent weighing process
- Print the report to a printer or PC based on the Print Settings
- Export the report as a PDF file to a USB flash drive

4.3.4 Sample Library – Parts Counting

The Explorer Plus balance features a built-in library for managing multiple sample profiles. Up to 3,000 library records can be saved and recalled for use. The total library capacity and records are accessible across various application modes and through the library menu. When the library usage exceeds 80%, a pop-up message will alert the user to export the library or delete all items. The entire library menu, please refer to 7.0 Library.

Create, Activate and Delete a Library

- Press “+New Library” button to create a new Library.
- When a new library is created, it remains inactive. The operator has to activate the library after ticking the box.
- Press on the RUBISH BIN button to delete a library.

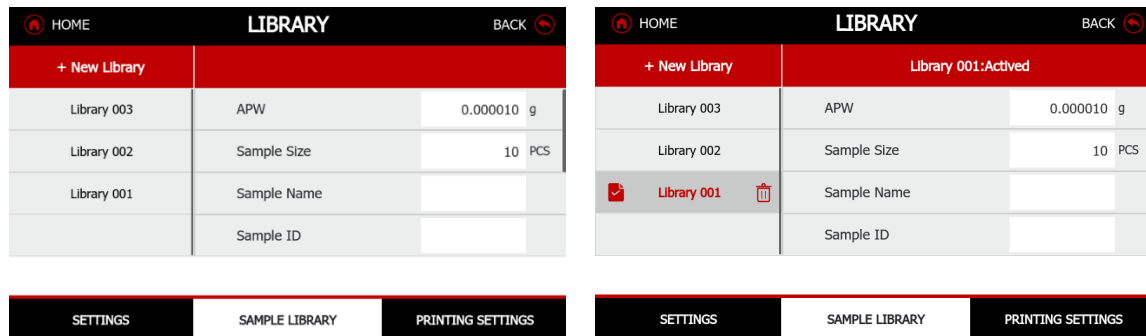

- After the library item is activated, the main screen will show the activated library number.

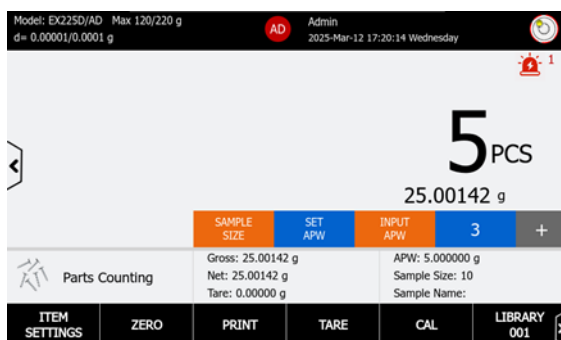

- Other sample information can be configured in the library, including sample name, sample ID, batch ID, lot ID, project ID, and the creation of 10 more customized ID.

4.3.5 Print Settings

The Explorer Plus balance offers advanced print settings. Users can customize the output format and content and direct it to Excel or save it in a USB-compatible format. Additionally, users can review the print content to ensure all items are correctly selected before printing on paper or PC.

For details of Print Settings, please refer to section 6.0.

4.4 Check Counting

- Use this application to check if the current sample pieces are within tolerances (e.g. an over and under limit).
- In the lower portion of the home screen, select Check Counting.
- Press **Tare** or **Zero** to start weighing.
- Place objects on the pan to check if the number of pieces are within the tolerances. The default over and under limit pieces is displayed.
- Setup the SAMPLE SIZE, Average Piece Weight (APW) before starting Check Counting application.

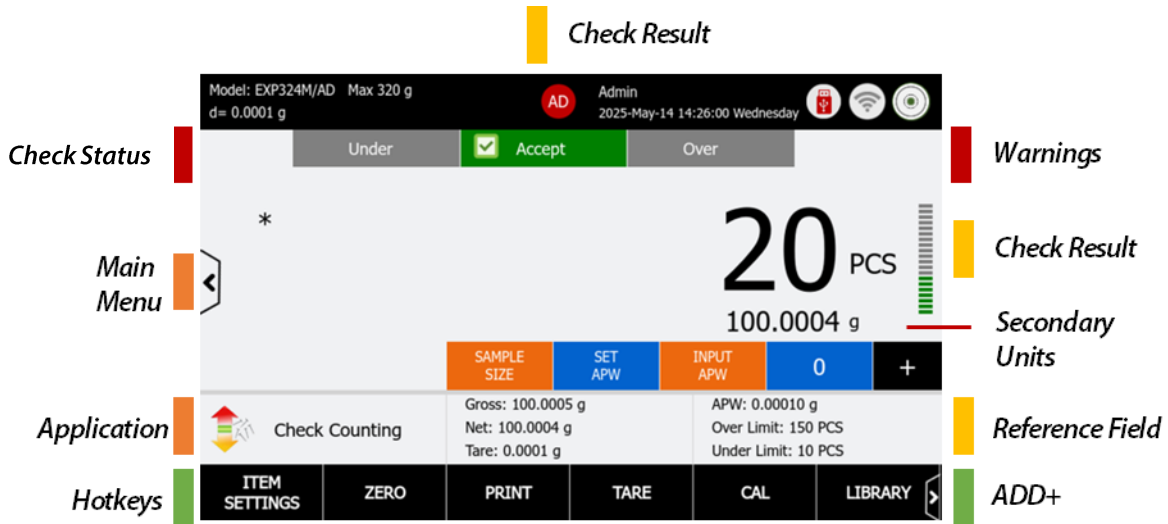

4.4.1 Application buttons and Reference Field

Application buttons/ Reference Field	Description
Sample Size	Input sample size
Set APW	Place the sample on the pan, the balance will calculate Average Piece Weight (APW)
Input APW	Input Average Piece Weight (APW)
0	The statistic key is to recall the number of check counting, and press this button, operator can review the statics results.
+	Press this button to manually accumulate weight. In Automatic Statistics mode, this button will be inactive.
Item Settings	<ul style="list-style-type: none"> • Auto Optimization: able to automatically optimized APW Auto Optimization improves counting accuracy. • Statistics: Automatic, Manual • Secondary Weighing Units: able to use 15 weighing units and 2 customer units • Audible Signal: The balance beeper will sound to alert the user of the check status. <ul style="list-style-type: none"> ■ Available Setting: Off, Under, Accept, Over, Under and Over

	<ul style="list-style-type: none"> Auto Tare: Automatic tare the container value
<p>Check Bar</p> 	<ul style="list-style-type: none"> Under-Orange indicator Accept-Green Indicator Over-Red Indicator The check status is divided into 20 segments to display the proportion of the current load relative to the total capacity. Each segment corresponds to 5% of the total capacity.
<p>Check Indicator</p>	<ul style="list-style-type: none"> Color-coded status indicators (green / orange / red) correspond to sample weight, visually signaling: <ul style="list-style-type: none"> ✓ Acceptable (green) ✚ Underweight (orange) ✖ Overload (red)
<p>Over Limit</p>	<ul style="list-style-type: none"> The piece value exceeds the maximum allowed threshold.
<p>Under Limit</p>	<ul style="list-style-type: none"> The piece value exceeds the maximum allowed threshold.

4.4.2 Begin Check Counting

Step 1: Establish an Average Piece Weight (APW)

Each time a new type of part is counted, the nominal weight of one piece (Average Piece Weight or APW) must be established using a small quantity of pieces.

Set a Known Average Piece Weight (APW)

- Press the INPUT APW button and enter the desired APW value.
- Tap ENTER to save the value

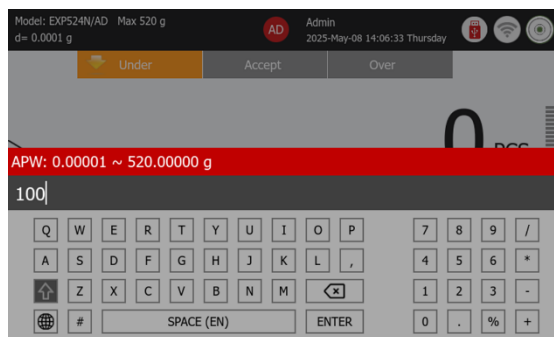
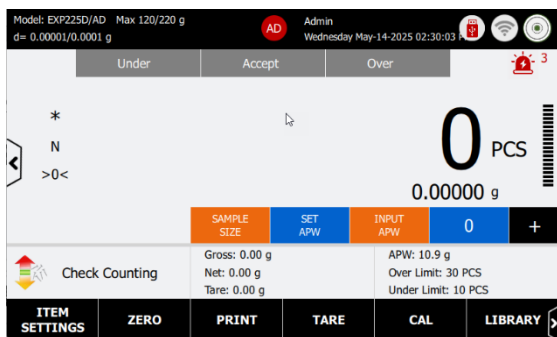

Set a new Average Piece Weight (APW) – Derived

- Press the Sample Size button and enter the desired Sample Size.
- Tap ENTER to save the value
- Place reference weight on the pan, and press Accept to establish a new APW.
- The sample size can be 1 to 10 000 pieces. The default sample size is 10.
- Once a sample size is changed, the balance will immediately recalculate APW screen, expecting to establish a new APW.
- Example: The home screen displays 10.00000 g at the new APW.

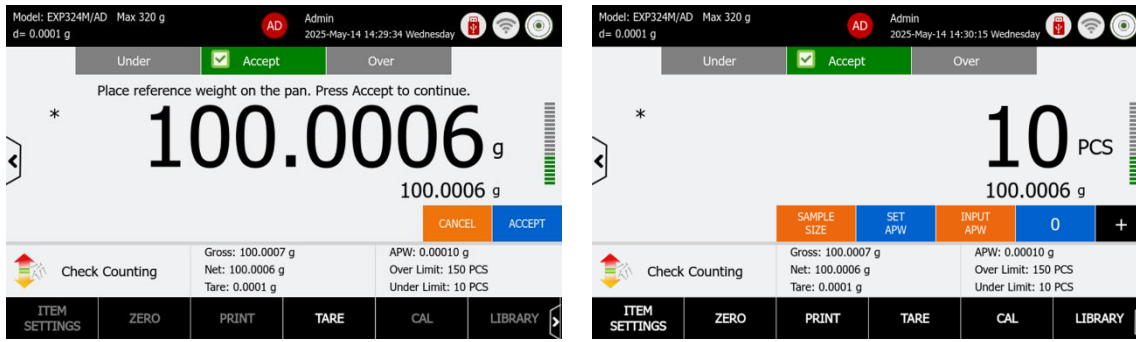

Step 2: Establish Over Limit and Under Limit and check the result

- The Over Limit and Under Limit are set in Library.
- The main screen will display the check status of the current sample in the library.
 - If the check status is either Under or Over, the lights will turn red to indicate this.
 - When the piece value exceeds the over limits, the screen will display Over.
 - When the piece value exceeds the under limits, the screen will display Under.
 - When the piece value is in the accept range, the screen will display Accept.
- Example: The home screen shows 30 pieces at the **Accept Range**.

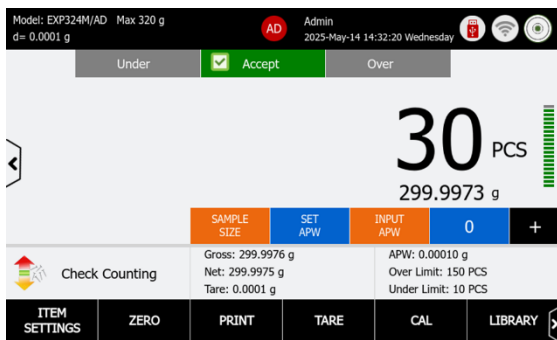

4.4.3 Accumulate the data for Check Counting

Utilize the Statistics "+" function to aggregate samples based on counting numbers and generate statistical reports.

The balance can store up to 99 accumulation records.

Step 1: Set the Statistic Mode in Parts Counting Mode

- Statistics can be determined Manual mode or automatically
- Automatic Mode: Weights are automatically recorded when stable

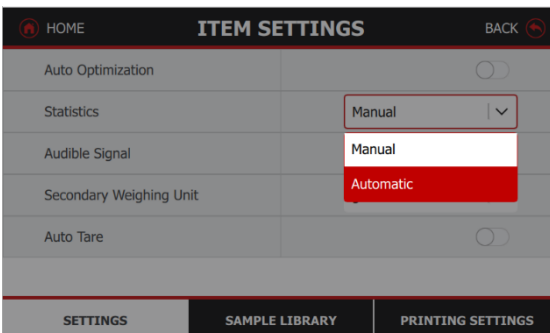

Step 2: Statistics Report View

- To use the statistics function, enable it first in the Item Settings.
- Add items and press the “+ Statistic button to accumulate the statistical data
- Tap the statistics number to view the statistical results.
- Statistics Report View
 - The report content includes Start Time, Number of Samples, Total, Average, Maximum, Minimum, Range, Standard Deviation, Relative Deviation % and individual item weighing values.

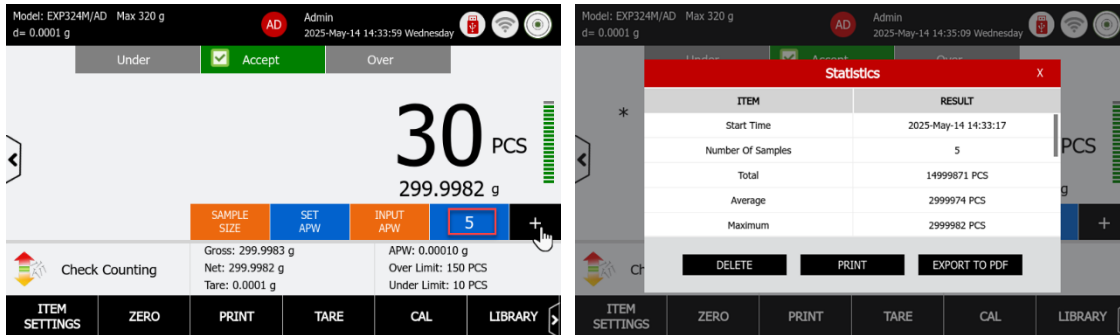

Step 3: Print Report

After reviewing the report, users can choose from several actions:

- Delete the statistics and restart the percent weighing process
- Print the report to a printer or PC based on the Print Settings
- Export the report as a PDF file to a USB flash drive

4.4.4 Sample Library – Check Counting

The Explorer Plus balance features a built-in library for managing multiple sample profiles. Up to 3,000 library records can be saved and recalled for use. The total library capacity and records are accessible across various application modes and through the library menu. When the library usage exceeds 80%, a pop-up message will alert the user to export the library or delete all items. The entire library menu, please refer to 7.0.

Create, Activate and Delete a Library

- Press “+New Library” button to create a new Library.
- When a new library is created, it remains inactive. The operator has to activate the library after ticking the box.
- Press on the RUBISH BIN button to delete a library.
- After the library item is activated, the main screen will show the activated library number.
- Other sample information can be configured in the library, including sample name, sample ID, batch ID, lot ID, project ID, and the creation of 10 more customized ID.

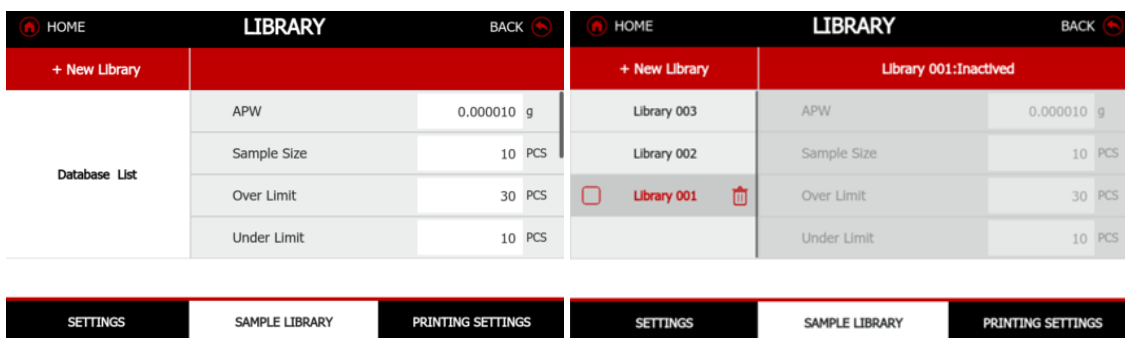

4.4.5 Print Settings

The Explorer Plus balance offers advanced print settings. Users can customize the output format and content and direct it to Excel or save it in a USB-compatible format. Additionally, users can review the print content to ensure all items are correctly selected before printing on paper or PC.

For details of Print Settings, please refer to section 6.0.

4.5 Percent Weighing

Use this application to display the current weight as a percentage of a reference weight.

- In the lower section of the home screen, select Percent Weighing.
- Place objects on the pan to display the percentage of a reference weight.
- Press **Tare** or **Zero** to start weighing.
- The default Reference weight is displayed.
- Setup the Reference Weight, Reference Adjust or Set Reference Weight before starting Percent Weighing application.

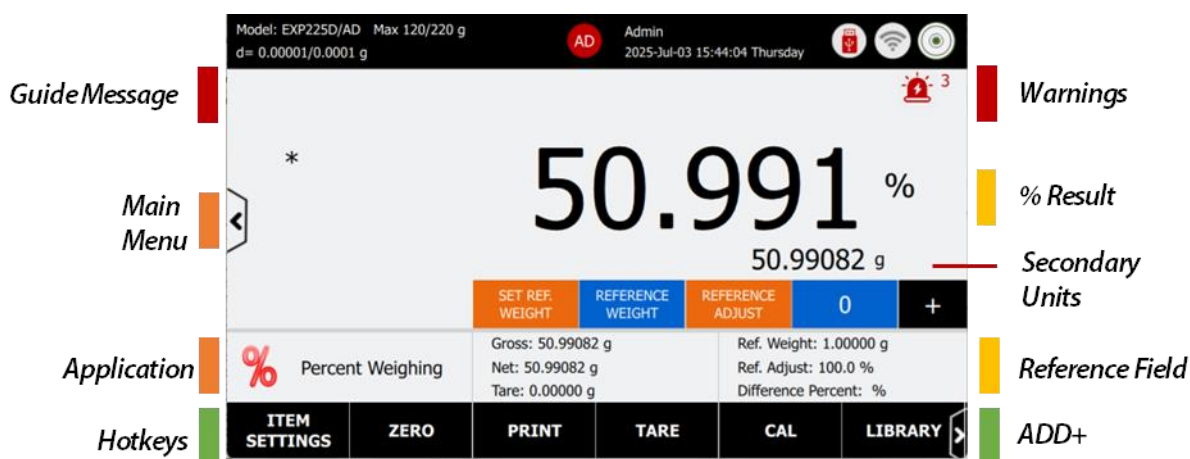

4.5.1 Application buttons and Reference Field

Application Button/ Reference Field	Description
Reference Weight	In manufacturing or quality control processes, a reference weight can be used to verify that products meet specified weight standards. The reference weight can be set within the range of 100d to the maximum capacity.
Reference Adjust	Reference adjust is a known value used to adjust the Reference Weight
Set Ref. Weight	Place the sample on the pan, the balance will store the reference weight.
0	The statistic key is to recall the number of percent weighing, and press this button, operator can review the statics results.

+	Press this button to manually accumulate weight. In Automatic Statistics mode, this button will be inactive.
Item Settings	<ul style="list-style-type: none"> Statistics: Automatic, Manual Secondary Weighing Units: able to use 15 weighing units and 2 customer units Auto Tare: Automatic tare the container value
Ref. Factor	<ul style="list-style-type: none"> It displays the percentage of the current reference weight, with the unit in %, accurate to one decimal place.
Diff. Factor	<ul style="list-style-type: none"> It displays the percentage difference between the sample weight and the predetermined reference weight in weighing calculations. The unit is %, accurate to two decimal places.

4.5.2 Begin Percent Weighing

Set a Known Reference Weight

- Press the REFERENCE WEIGHT button and enter the desired Reference Weight value.
- Tap ENTER to save the value
- Example: The home screen displays 50.00000 g as the Reference Weight.

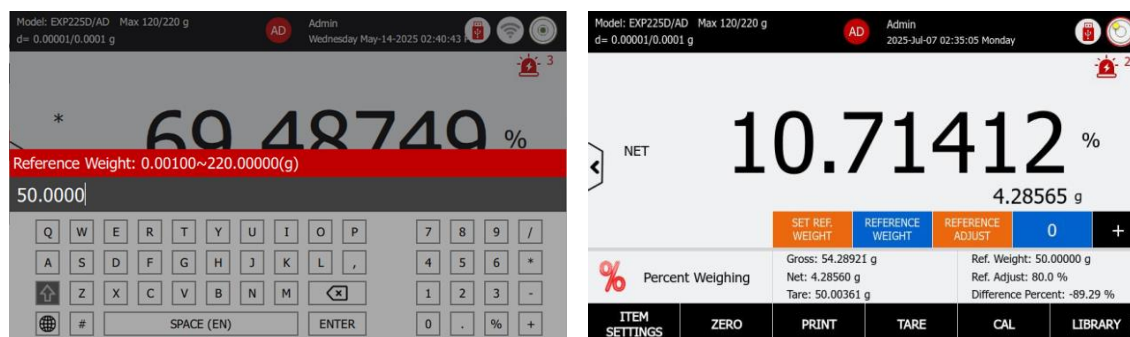

Set a new Reference Weight – Derived

- Place reference weight on the pan, and press Accept to establish a new Reference Weight
- The home screen displays 4.28821 g at the new Reference Weight

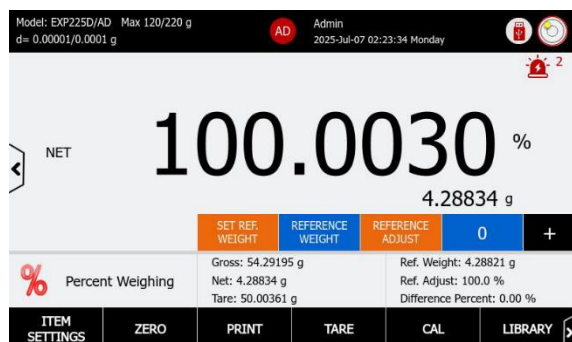

Step 2: Establish a Reference Adjust

Adjust the reference to a desired adjust.

- Press the REFERENCE ADJUST button and set the adjust percentage.
- Tap ENTER to save the value
- If a library is activated, the new Reference Weight will overwrite the existing value in the library.

- Example: The home screen displays an 80% Ref. Adjust for adjusting the Reference Weight.

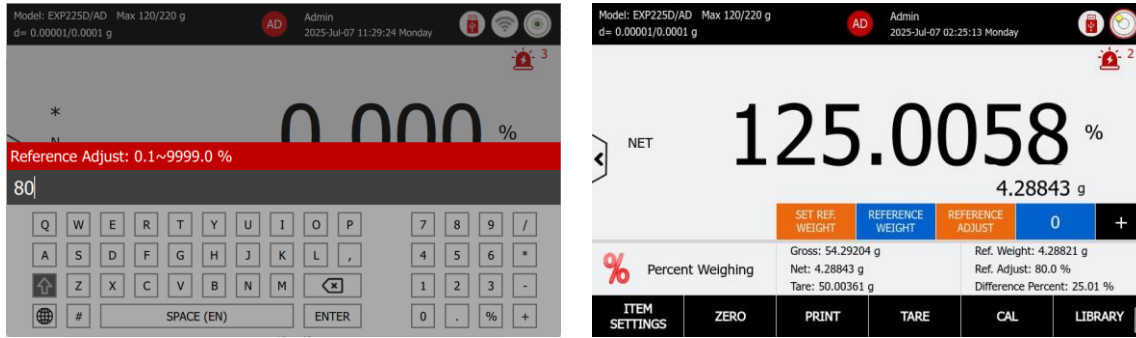

Step 3: Weighing the Samples

Place an object on the pan. The difference between the sample and the Reference Weight is displayed as both a weight and a percentage.

Place samples on the pan, the balance will display the percentage of reference weight. The reference weight value, the set of ref adjust and difference percent will display in the reference field.

4.5.3 Accumulate the data for Percent Weighing

Utilize the Statistics "+" function to aggregate samples based on the numbers of samples and generate statistical reports. The balance can store up to 99 accumulation records.

Step 1: Set the Statistic Mode in Percent Weighing Mode

- Statistics can be determined using manual mode or automatic.
- Automatic Mode: Weights are automatically recorded when stable

Step 2: Statistics Report View

- To use the statistics function, enable it first in the Item Settings.
- Add items and press the "+" Statistic button to accumulate the statistical data
- Tap the statistics number to view the statistical results.
- Statistics Report View
 - The report content includes Start Time, Number of Samples, Total, Average, Maximum, Minimum, Range, Standard Deviation, Relative Deviation % and individual item percent weighing values.

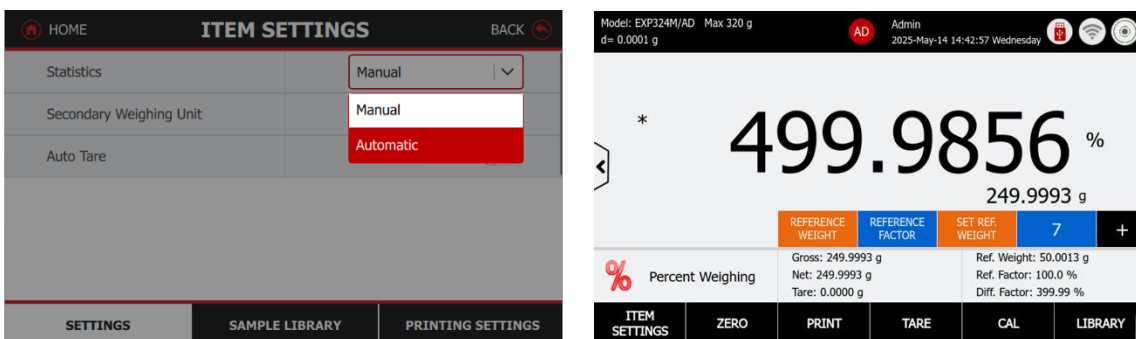

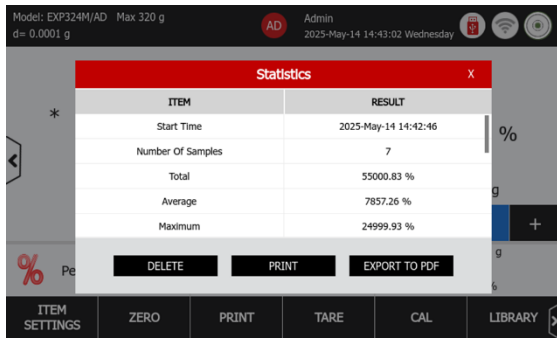

Step 3: Print Report

After reviewing the report, users can choose from several actions:

- Delete the statistics and restart the percent weighing process
- Print the report to a printer or PC based on the Print Settings
- Export the report as a PDF file to a USB flash drive

4.5.4 Sample Library – Percent Weighing

The Explorer Plus balance features a built-in library for managing multiple sample profiles. Up to 3,000 library records can be saved and recalled for use. The total library capacity and records are accessible across various application modes and through the library menu. When the library usage exceeds 80%, a pop-up message will alert the user to export the library or delete all items. The entire library menu, please refer to 7.0.

Create a Library Record

- Press “+New Library” button to create a new Library.
- When a new library is created, it remains inactive. The operator has to activate the library after ticking the box.
- Press on the RUBISH BIN button to delete a library.
- After the library item is activated, the main screen will show the activated library number.

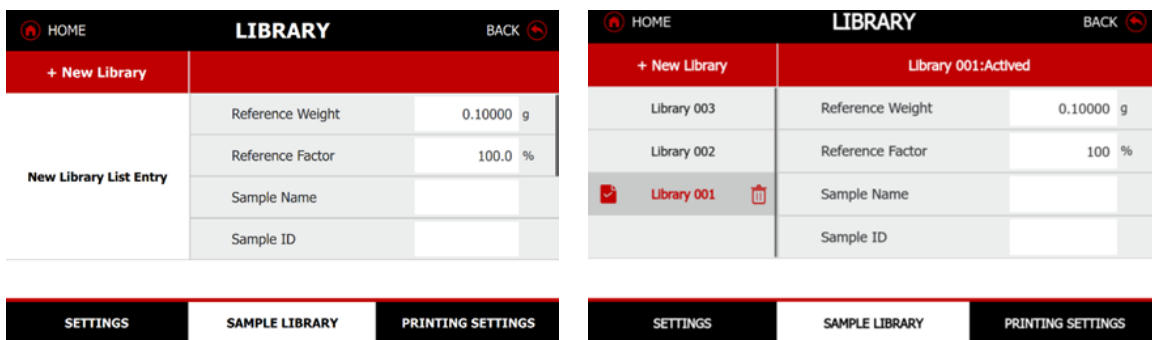

- Other sample information can be configured in the library, including sample name, sample ID, batch ID, lot ID, project ID, and the creation of 10 more customized ID.

4.5.5 Print Settings

The Explorer Plus balance offers advanced print settings. Users can customize the output format and content and direct it to Excel or save it in a USB-compatible format. Additionally, users can review the print content to ensure all items are correctly selected before printing on paper or PC.

For details of Print Settings, please refer to section 6.0.

4.6 Check Weighing

- Use this application to check if the current sample pieces are within tolerances (e.g. an over and under limit, nominal weight vs. \pm tolerance).
 - This function serves to alert the operator of the check status and overload lights rather than requiring them to read the weighing value from the working distance
- In the lower portion of the home screen, select Check Weighing.
- Press **Tare** or **Zero** to start weighing.
- Place objects on the pan to check if the number of pieces is within the tolerances. The default over and under limit pieces is displayed.
- Setup the Over and Under Limits, and or Nominal weight & Tolerance before starting Check Weighing application.

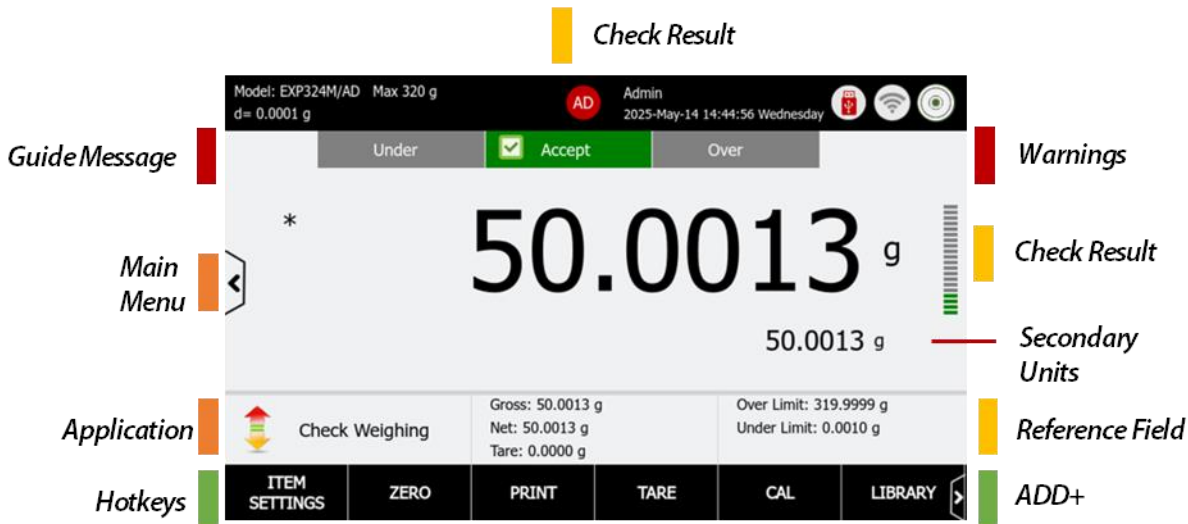

4.6.1 Reference Field

Reference Field	Description
Over Limit	The piece value exceeds the maximum allowed threshold.
Under Limit	The piece value is below the minimum allowed threshold.
Item Settings	<ul style="list-style-type: none"> • Limits Setting Mode: check result with different limits setting. <ul style="list-style-type: none"> ■ Under and Over ■ Nominal weight and Tolerance ■ Nominal Weight and Percent Tolerance • Display: Weight or Check Status • Audible Signal: The balance beeper will sound to alert the user of the check status. <ul style="list-style-type: none"> ■ Available Setting: Off, Under, Accept, Over, Under and Over • Primary Weighing Unit: The default unit is grams. The operator can switch to alternative weighing units and two custom units.

	<ul style="list-style-type: none"> • Secondary Weighing Units: able to use 15 weighing units and 2 custom units
	<ul style="list-style-type: none"> • The check status are divided into 20 segments to display the proportion of the current load relative to the total capacity. Each segment corresponds to 5% of the total capacity. • Under-Orange indicator • Accept-Green Indicator • Over-Red Indicator

4.6.2 Begin Check Weighing

Step 1: Establish an Over Limits and Under Limits

- The Over Limit and Under Limit are set in Library.
- The main screen will display the check status of the current sample in the library.
- If the check status is either Under or Over, the status lights will turn red to indicate this.
- When the piece value exceeds the over limit, the screen will display Over.
 - When the piece value below the under limit, the screen will display Under.
 - When the piece value is above the under limit and below the over limit, the screen will display Accept.

In ITEM SETTINGS, select the Mode as Over and Under, Nominal Weight Tolerance, or Nominal Percent Tolerance.

Example: The home screen displays 60.0000 grams as Over Limited Value, and 50.0013 g is in the range of Accept.

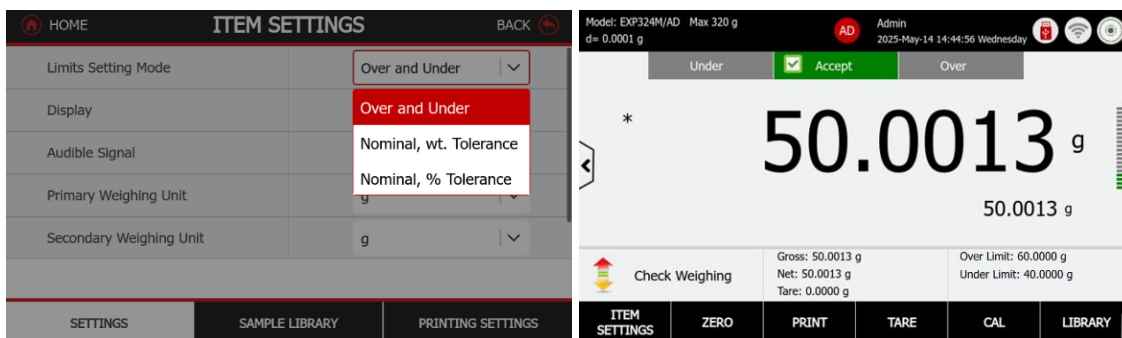

Step 2: Set the check result display as Under, Accept and Over

This function serves to alert the operator of the check status and overload lights rather than requiring them to read the weighing value from the working distance

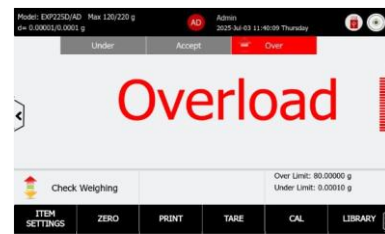
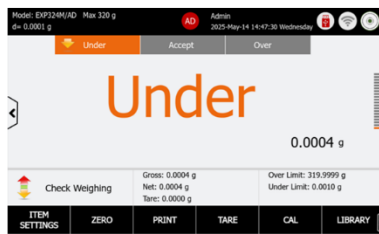
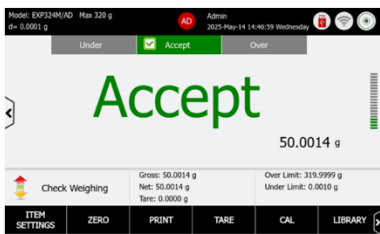
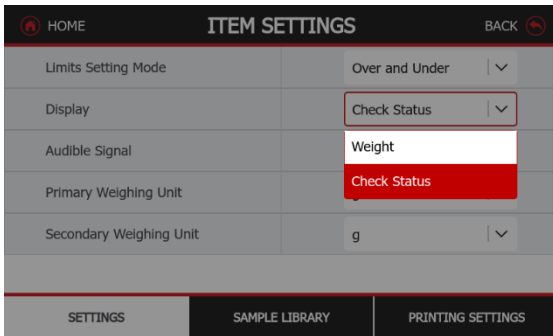

Step 3: Set up the Audible Signal

The operator can configure check sounds for Under, Accept, and Over in the Item Settings menu. Available Setting: Off, Under, Accept, Over, Under and Over

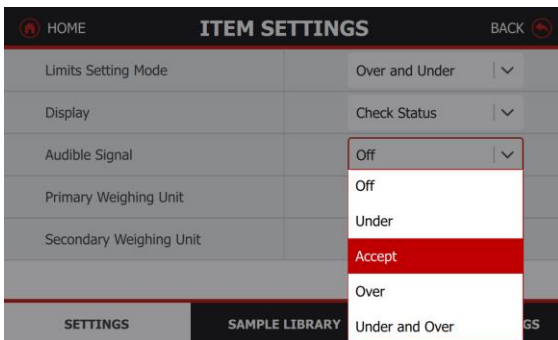

4.6.3 Sample Library – Check Weighing

The Explorer Plus balance features a built-in library for managing multiple sample profiles. Up to 3,000 library records can be saved and recalled for use. The total library capacity and records are accessible across various application modes and through the library menu. When the library usage exceeds 80%, a pop-up message will alert the user to export the library or delete all items. The entire library menu, please refer to 7.0.

Create, Activate and Delete a Library

- Press “+New Library” button to create a new Library.
- When a new library is created, it remains inactive. The operator has to activate the library after ticking the box.
- Press on the RUBISH BIN button to delete a library.
- After the library item is activated, the main screen will show the activated library number.
- Example: Limits setting mode is Under and Over

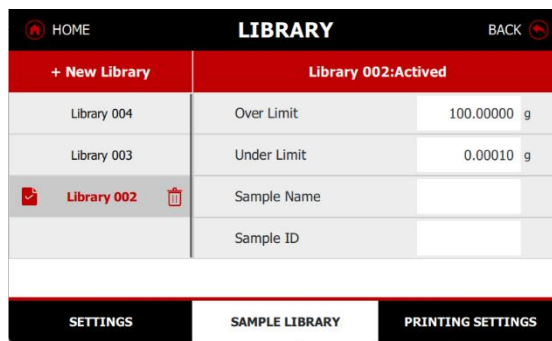
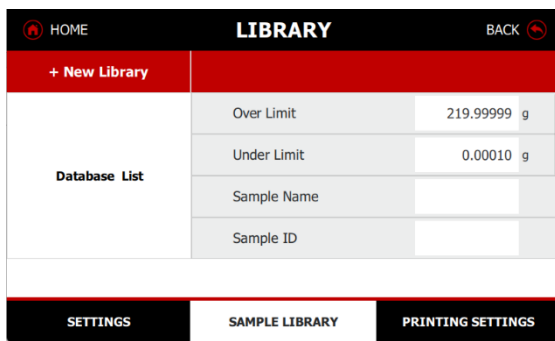

Example: Nominal weight and Tolerance

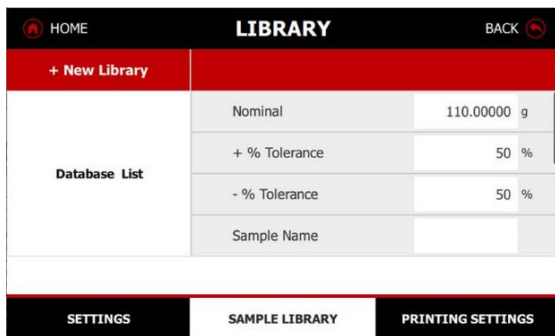

Example: Nominal Weight and Percent Tolerance

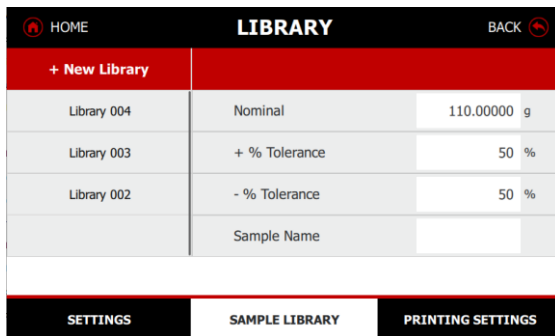

Other sample information can be configured in the library, including sample name, sample ID, batch ID, lot ID, project ID, and the creation of 10 more customized ID.

4.6.4 Print Settings

The Explorer Plus balance offers advanced print settings. Users can customize the output format and content and direct it to Excel or save it in a USB-compatible format. Additionally, users can review the print content to ensure all items are correctly selected before printing on paper or PC.

For details of Print Settings, please refer to section 6.0.

4.7 Dynamic Weighing

This function serves to weigh objects that are not stable, such as animals.

- In the lower portion of the home screen, select Dynamic Weighing.
- Press **Tare** or **Zero** to start weighing.
- Place the moving sample on the pan to achieve an average weight reading within seconds. The default weighing average time is displayed.
- Setup the Start Mode, Weighing Average Time, Auto Print Result before starting Check Weighing application.

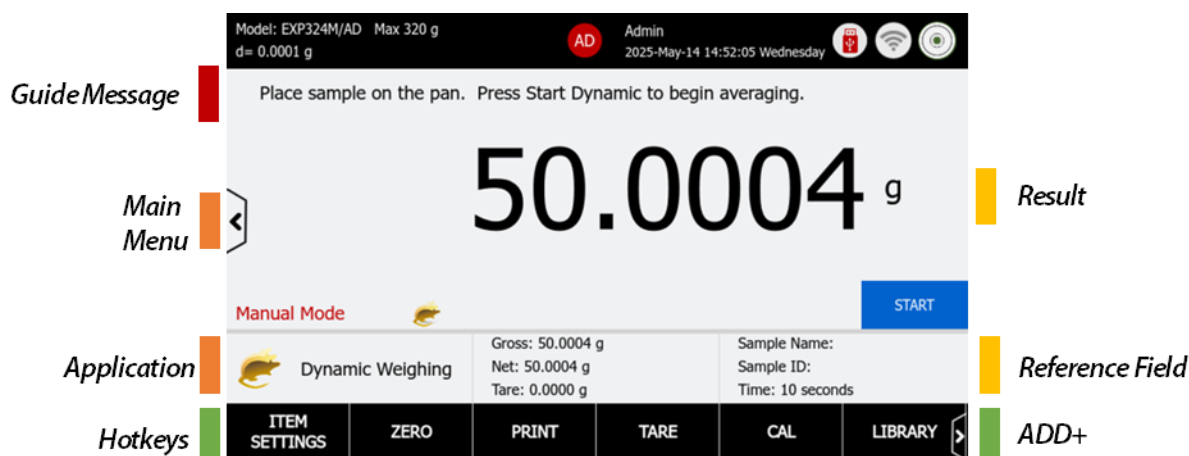

4.7.1 Application buttons

Application Button/ Reference Field	Description
Start	Press "Start" button to begin averaging.
Time	It displays the averaging time.
Item Settings	<ul style="list-style-type: none"> • Start Mode: Automatic and Manual Automatic start without press Start button after second dynamic weighing • Auto Print Result: The averaged result will be printed immediately, without press "Print" button in the main screen. • Main Unit: The default setting is gram. It is able to change to other weighing units • Auto Tare: Automatic tare the container value

4.7.2 Begin Dynamic Weighing

Step 1: Setup the weighing averaging time in the Sample Library

- The weighing averaging time is set in Library.
- The main screen will display the average weight of the current sample.

Example: The screen displays 10 seconds as the averaging time.

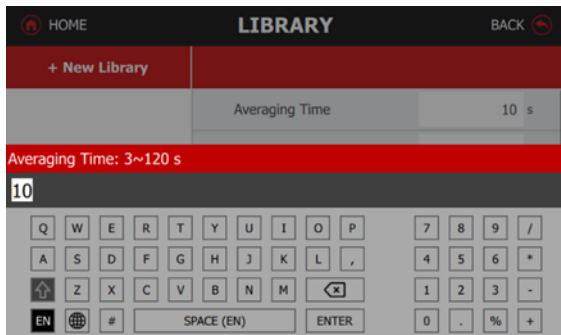

Step 2: Weigh movement sample on the weighing pan

- Place a sample on the weighing pan, and the balance will immediately calculate the average weight.
- The process will then commence a countdown based on the pre-set time configuration.
- The moving mouse icon will be stop at the end of the process, the result will be highlighted.

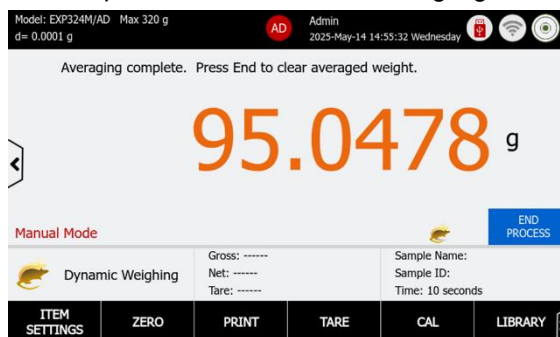
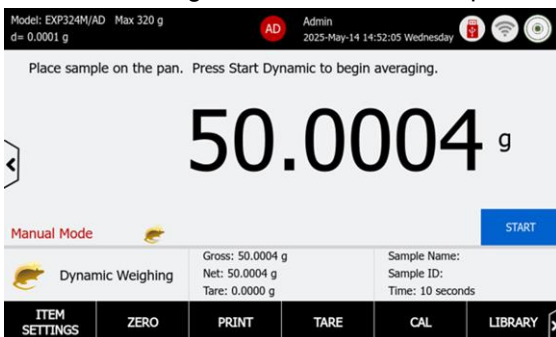

4.7.3 Sample Library – Dynamic Weighing

The Explorer Plus balance features a built-in library for managing multiple sample profiles. Up to 3,000 library records can be saved and recalled for use. The total library capacity and records are accessible across various application modes and through the library menu. When the library usage exceeds 80%, a pop-up message will alert the user to export the library or delete all items. The entire library menu, please refer to 7.0.

Create, Activate and Delete a Library

- Press “+New Library” button to create a new Library.
- When a new library is created, it remains inactive. The operator has to activate the library after ticking the box.
- Press on the RUBISH BIN button to delete a library.
- After the library item is activated, the main screen will show the activated library number.

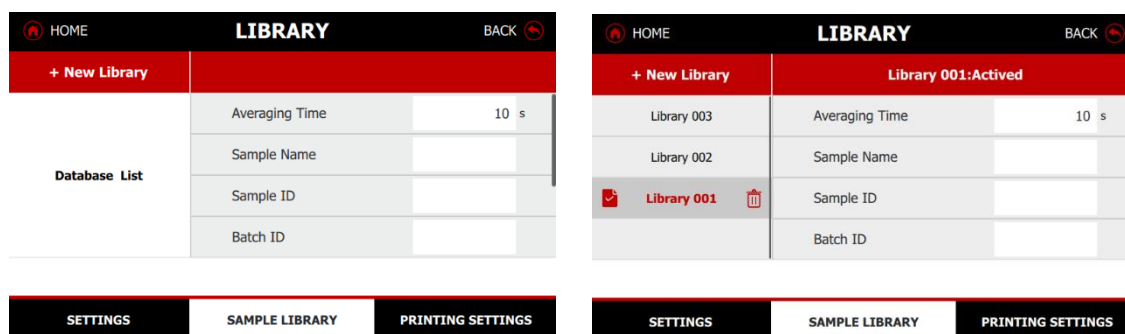

4.7.4 Print Settings

The Explorer Plus balance offers advanced print settings. Users can customize the output format and content and direct it to Excel or save it in a USB-compatible format. Additionally, users can review the print content to ensure all items are correctly selected before printing on paper or PC.

For details of Print Settings, please refer to section 6.0.

4.8 Totalization

This function serves is used to sum the weights of multiple samples and report the statistical data for the series of samples.

- In the lower portion of the home screen, select Totalization.
- Press **Tare** or **Zero** to start weighing.
- Place the series sample on the pan. Press the Accumulate button to add up the weights. The total weight of the samples will be displayed in the reference field.
- Setup the Start Mode before starting Totalization application.

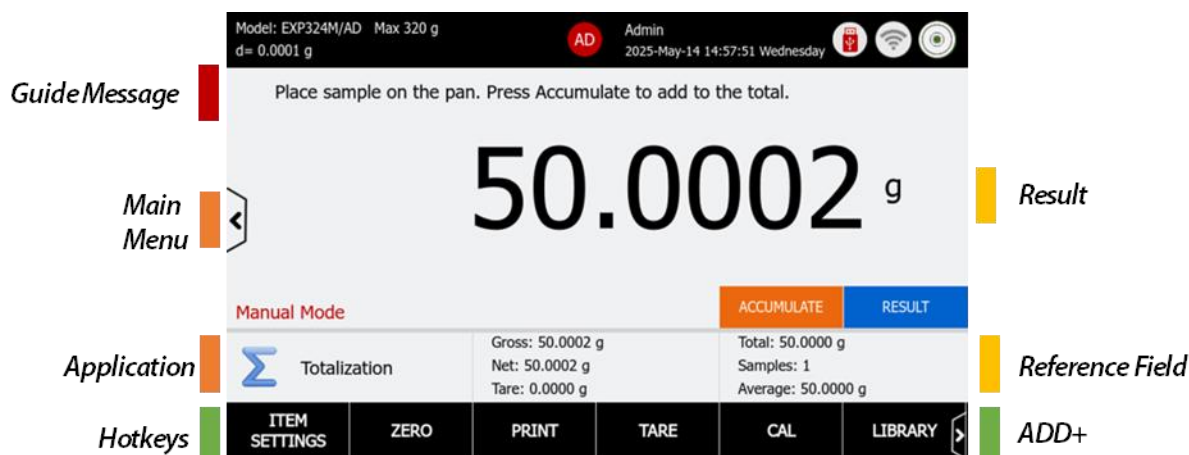

4.8.1 Application buttons

Application Button/ Reference Field	Description
Accumulate	Press the “Accumulate” button to add up the sample weight.
Result	Press “Result” button to review the total and other statistic data
Item Settings	<ul style="list-style-type: none"> Start Mode: Automatic and Manual. Automatic start without press Accumulate button after second sample weighing Primary Weighing Unit: The default unit is grams. The operator can switch to alternative weighing units and two custom units. Auto Tare: Automatic tare the container value

4.8.2 Begin Totalization

Step 1: Setup the start mode in the Item Settings

- Start Mode: Automatic and Manual. Automatic start without pressing Accumulate button after second sample weighing.

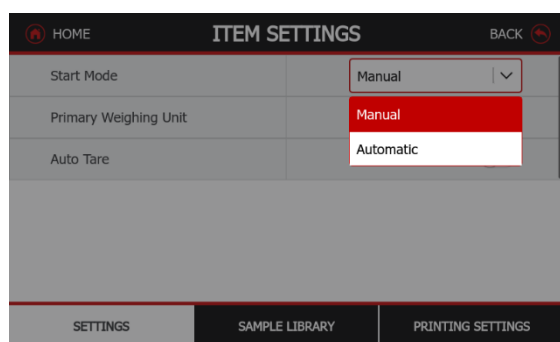

Step 2: Weigh the samples on the weighing pan

- Place a sample on the weighing pan,
- Press the Accumulate button to add up the weights.

Example: The home screen displays 50.0002 gram as the fourth weight value and press Result button to review the data

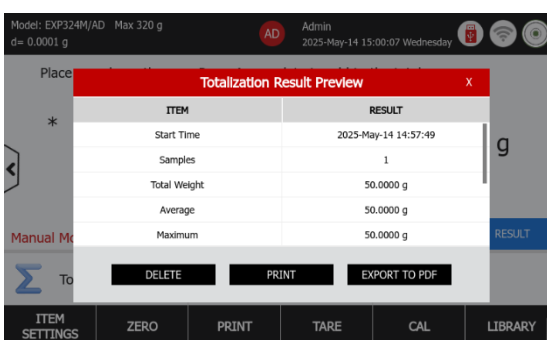
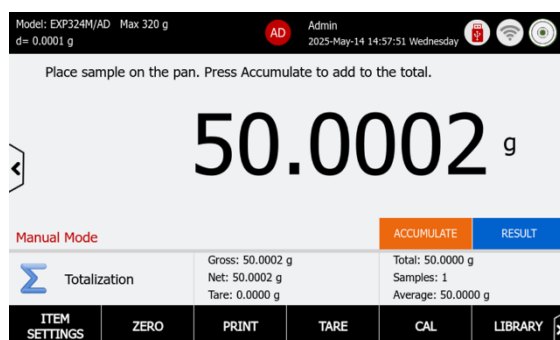

4.8.3 Accumulate the data for Totalization

Utilize the Accumulate function to aggregate samples and generate statistical reports.

The balance can store up to 99 accumulation records. Tap the Result to view the totalization and other statistical results.

The report content includes Start Time, Number of Samples, Total, Average, Maximum, Minimum, Range, Standard Deviation, Relative Deviation % and individual item weighing values.

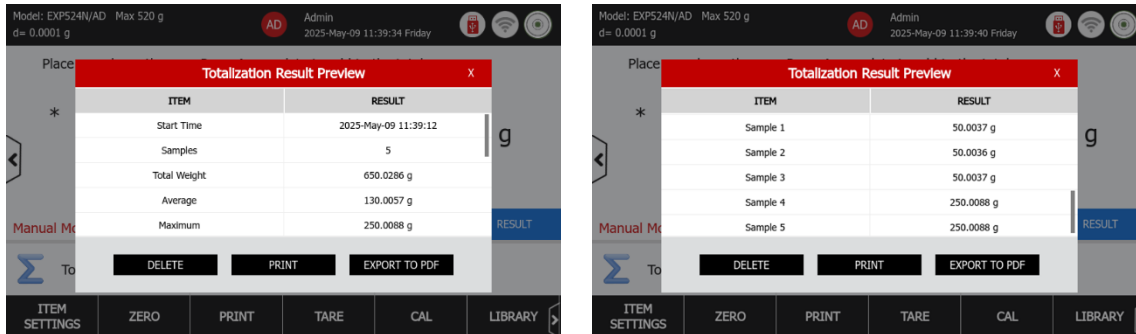

4.8.4 Sample Library – Totalization

The Explorer Plus balance features a built-in library for managing multiple sample profiles. Up to 3,000 library records can be saved and recalled for use. The total library capacity and records are accessible across various application modes and through the library menu. When the library usage exceeds 80%, a pop-up message will alert the user to export the library or delete all items. The entire library menu, please refer to 7.0.

Create, Activate and Delete a Library

- Press “+New Library” button to create a new Library.
- When a new library is created, it remains inactive. The operator has to activate the library after ticking the box.
- Press on the RUBISH BIN button to delete a library.
- After the library item is activated, the main screen will show the activated library number.

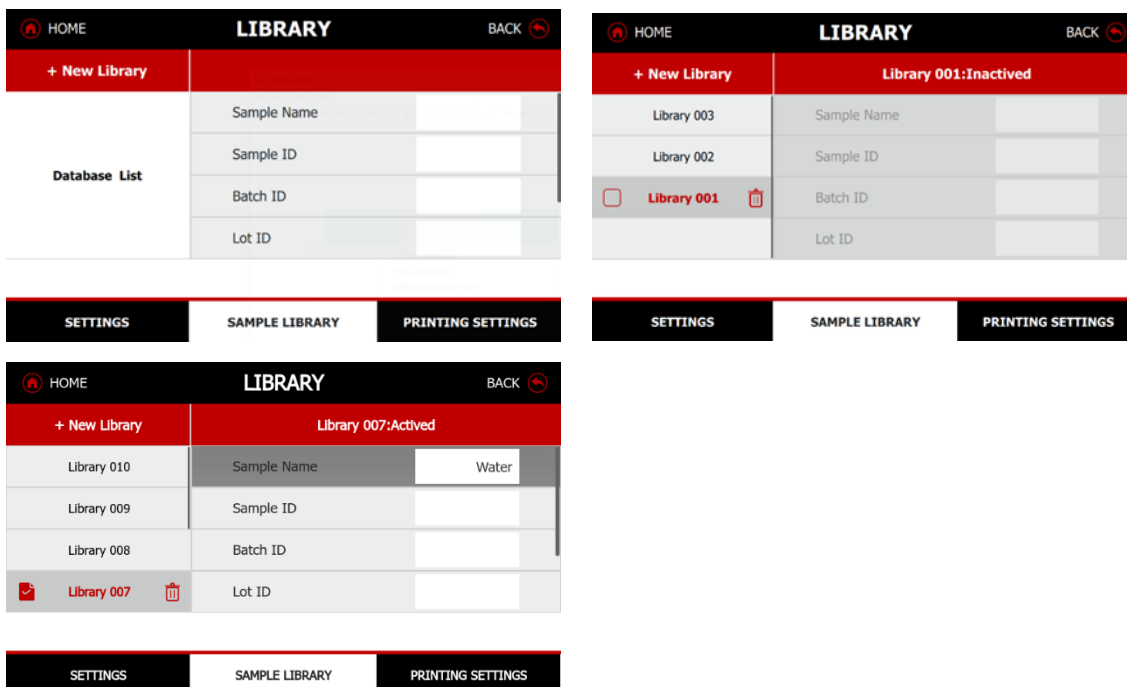

4.8.5 Print Settings

The Explorer Plus balance offers advanced print settings. Users can customize the output format and content and direct it to Excel or save it in a USB-compatible format. Additionally, users can review the print content to ensure all items are correctly selected before printing on paper or PC.

For details of Print Settings, please refer to section 6.0.

4.9 Formulation

This function serves to combine various elements in proportionate amounts. It has two formulation modes, free recipe and recipe-based formulation. Both modes allow filler to increase the volume of the formulation, enabling the dosage form to achieve the desired size and weight. This is particularly important for formulations containing small amounts of active pharmaceutical ingredients (APIs).

- In the lower portion of the home screen, select Formulation.
- Press **Tare** or **Zero** to start weighing.
- Place the ingredients on the pan to start the process. The total weight of the samples will be displayed in the reference field.
- Setup the Filler weight before starting Formulation application.

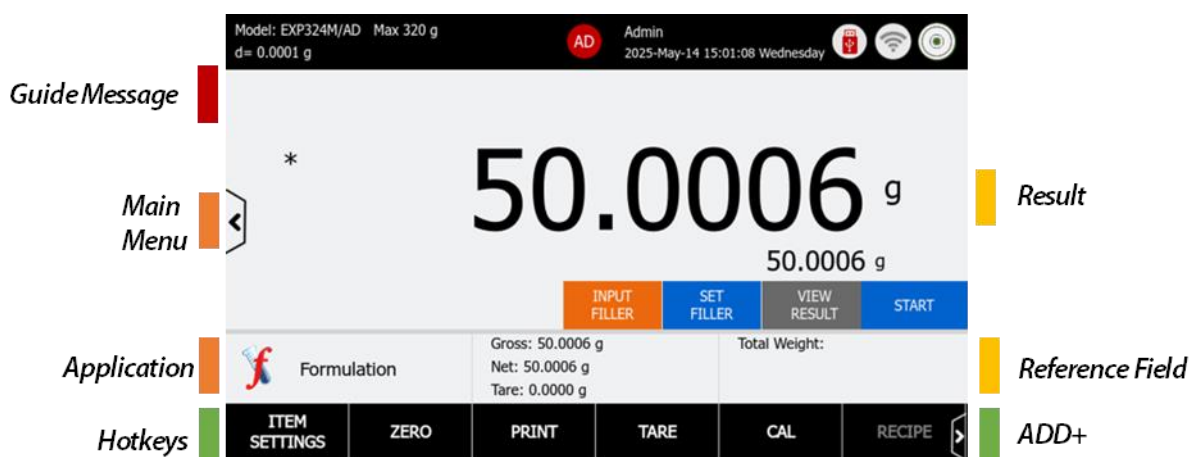

4.9.1 Application buttons

Application Button/ Reference Field	Description
Input Filler	Input Filler value
Set Filler	Place Filler on the pan and accept the value
View Result	Press this button to view the formulation results once the process has finished.
Start	Press the button to start formulation.
Diff. (wt.):	Display the weight difference.

Diff. (%)	Display the difference in percentage.
Target	Display the target weight based on the recipe library.
Item Settings	<ul style="list-style-type: none"> Formulation Mode: Recipe Based and Free Formulation The system can store up to 99 ingredients in a recipe, and there are 25 recipes available for setup. Filler: Turn on and off Primary Weighing Unit: The default unit is grams. The operator can switch to alternative weighing units and two custom units. Secondary Weighing Unit: The operator can switch to alternative weighing units and two custom units. Auto Tare: Automatic tare the container value

4.9.2 Begin Free Formulation

Step 1: Setup the formulation mode in the Item Settings

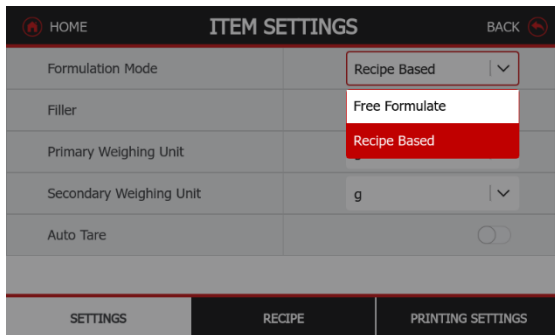

Step 2: Input Filler

- If the user has enabled the Filler option in the item settings, a filler value must be entered before creating a Free Recipe.
- The user can input the filler value by pressing the "Input Filler" button.
- Alternatively, the user can place the filler on the weighing pan and store the displayed value as the Filler weight.

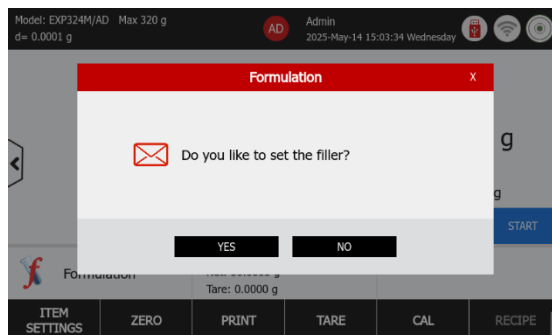
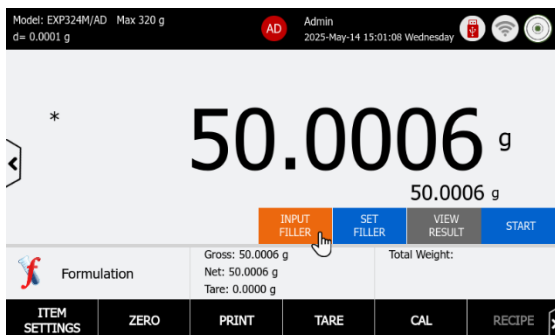

Weigh the samples on the weighing pan

- Place a sample on the weighing pan,
- Press the Accumulate button to add up the weights.
- The user can choose to Add this free formulation to Recipe for future use in Recipe based formulation
- Print the Result or transfer the data to a PDF file using a USB flash drive.

Example: The home screen displays 199.9982 gram as the fourth weight value and press **View Result** button to review the data

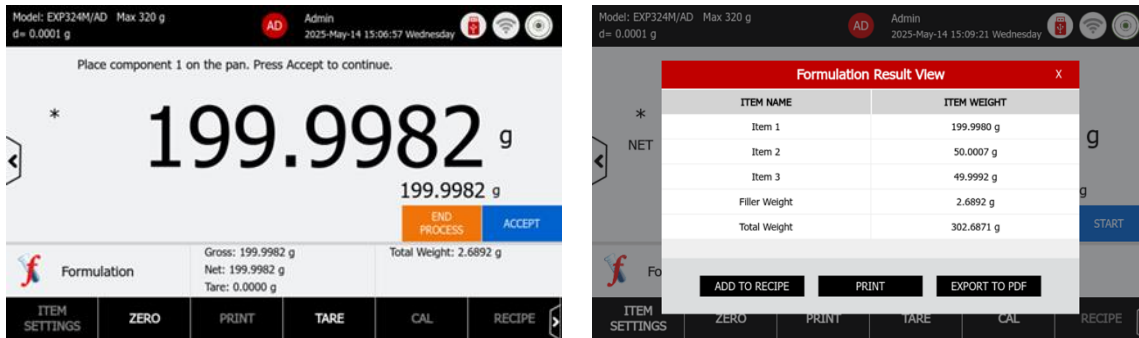

4.9.3 Begin Recipe Based Formulation

Step 1: Setup the formulation mode in the Item Settings

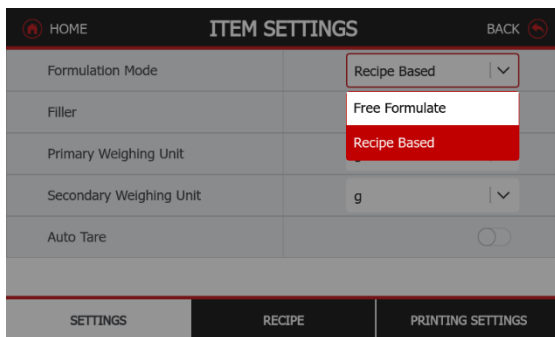

Step 2: Create Recipe ID and Name

- Press the **Create Recipe** button and create a New Recipe Name
- Click the tick box to activate Recipe 01
- Press the **Edit** button to go to next step

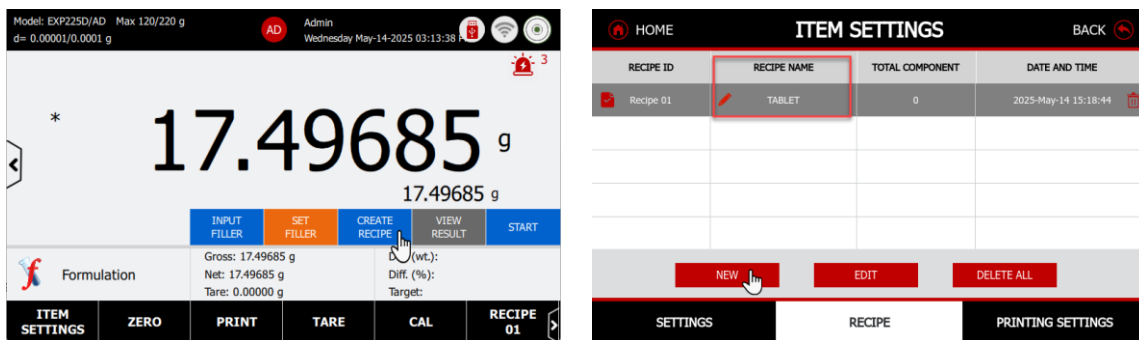

Step 2: Input Filler

- If the user has enabled the Filler option in the item settings, a filler value must be entered before creating a Free Recipe.
- The user can input the filler value by pressing the "Input Filler" button.

Alternatively, the user can place the filler on the weighing pan and store the displayed value as the Filler weight.

Step 3: Create Recipe Items

- Press **Add New** button to create ingredient names and their corresponding weight in grams.
- Use the **Up** and **Down** buttons to adjust the sequence order of the ingredients.
- Press the **Save** button before exiting the Recipe screen.
- Once the recipe has been saved, the user can press the **Start** button to begin the formulation process.

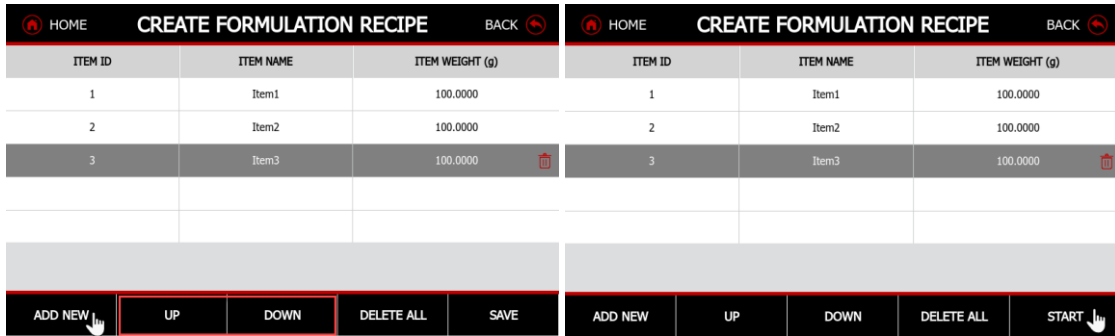

Step 4: Weigh the ingredients in the order by activated Recipe.

- Place the sample on the weighing pan and press the Accept button to confirm the weight.
- Follow the on-screen guide messages and repeat this process until all ingredients have been weighed.
- Once the process is completed, a result screen will appear with a button to review the data.
- The user can choose to Print the Result or transfer the data to a PDF file using a USB flash drive.

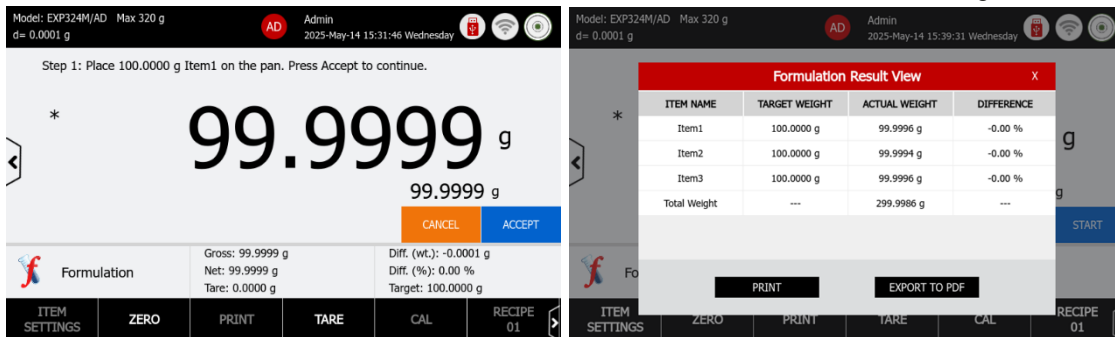

4.9.4 Print Settings

The Explorer Plus balance offers advanced print settings. Users can customize the output format, and content and direct it to Excel or save it in a USB-compatible format. Additionally, users can review the print content to ensure all items are correctly selected before printing on paper or PC.

For details of Print Settings, please refer to section 6.0.

4.10 Differential

This function serves to calculate the difference in weights of multiple samples taken at different times.

- In the lower portion of the home screen, select Differential.
- Press **Tare** or **Zero** to start weighing.
- Setup the Sample Groups number before starting Differential Weighing. The initial weight, final weight and difference weight will be displayed in the reference field.

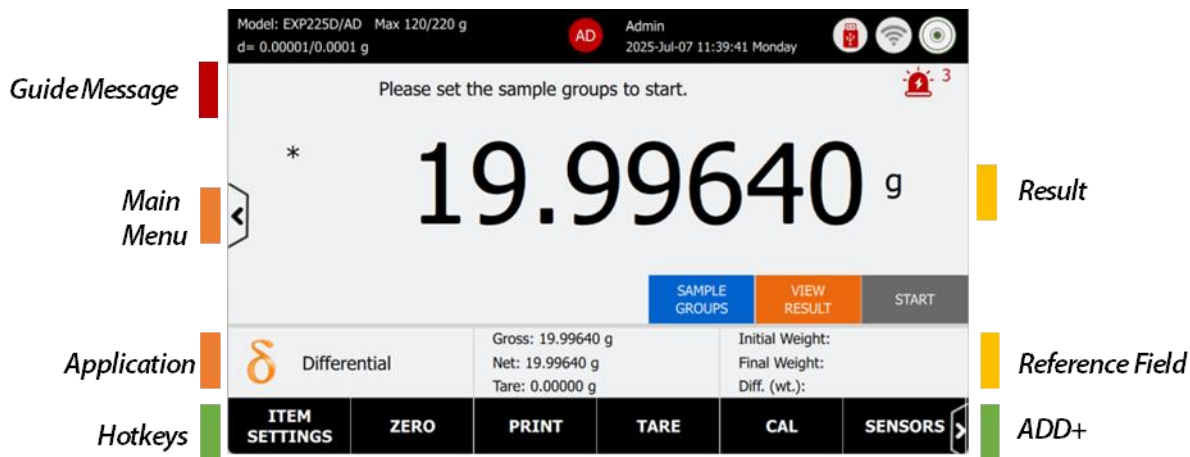

4.10.1 Application Buttons

Application Button	Description
Sample Groups	The number of sample groups requiring both initial and final weight measurements.
View Result	Press this button to view the Differential results once the process has finished.
Start	Press Start button to start the process
Accept	Accept the weight on the pan.
End Process	Press this button to complete the process
Initial Weight	Display the sample initial weight value.
Final Weight	Display the sample final weight value.
Difference Weight	Display the difference weight between initial and final measurement.
Item Settings	Sample Sequence: Off, A set of the initial and final weight

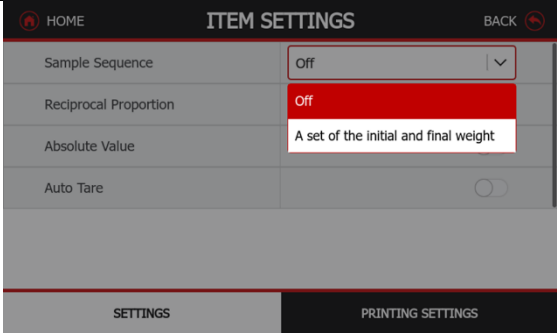

Reciprocal Proportion: ON/OFF

Absolute Value

Auto Tare: Automatic tare the container value

Sample Sequence mode

- Off: After weight the series samples initial weight, and then weight the final weight.
 - Weigh the initial weight of items 1, 2, 3, 4, 5, and then weigh the final weight of items 1, 2, 3, 4, 5.
- The set of sample measurement is design to place sample initial and final weight in a set
 - Weigh the initial weight of items 1 and then final weight,
 - After the first step, user weigh the initial weight of items 2 and then the final weight of items 2

Reciprocal Mode

- Set on off:
 - $Difference\ Weight = Final\ Weight - Initial\ Weight$
- Set it on:
 - $Difference\ Weight = Initial\ Weight - Final\ Weight$

Absolute Value

The difference result will be positive no matter initial weight is heavier than final weight

- Set it on:
 - $Difference\ Weight = |Final\ Weight - Initial\ Weight|$

4.10.2 Begin Differential Weighing

Step 1: Setup Group Sample: Multiple samples can be tested in the differential weighing application.

- Input Sample Groups

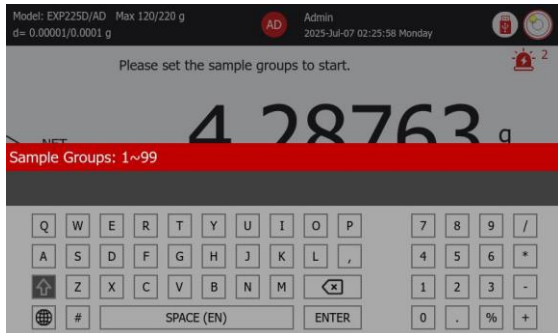

Step 2: Establish the initial weight of each sample

- Press START button and place the sample on the pan
 - Press Accept to confirm the initial weight
 - Follow the on-screen guide messages and repeat this process until all samples initial weight have been weighed.
1. After that process, weigh the sample final weight in order, and the result screen will pop up at the end.

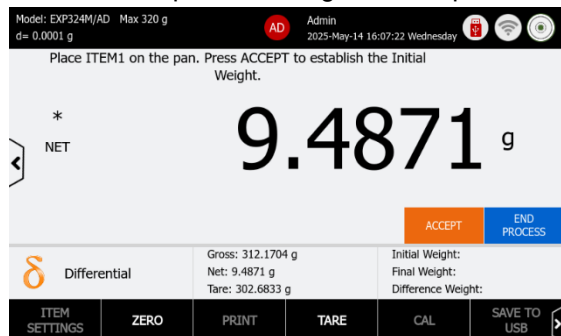

Step 2: Result Review

- The results include the initial weight, the final weight, the difference in weight, and the percentage difference.
- Users can clear the information, print the results to a PC or printer, and transfer the data to a PDF file via a USB flash drive.

#	INITIAL WEIGHT	FINAL WEIGHT	DIFFERENCE WEIGHT	DIFFERENCE %
ITEM1	9.4870 g	9.4870 g	0.0000 g	0.0 %
ITEM2	9.4870 g	9.4870 g	0.0000 g	0.0 %
ITEM3	9.4870 g	9.4870 g	0.0000 g	0.0 %
ITEM4	9.4870 g	9.4870 g	0.0000 g	0.0 %
ITEM5	9.4870 g	9.4870 g	0.0000 g	0.0 %

4.10.3 Print Settings

The Explorer Plus balance offers advanced print settings. Users can customize the output format and content and direct it to Excel or save it in a USB-compatible format. Additionally, users can review the print content to ensure all items are correctly selected before printing on paper or PC.

For details of Print Settings, please refer to section 6.0.

4.11 Density Determination

This function serves to determine the density of a solid or a liquid.

A density determination kit must be installed on the balance. For installation instructions, please refer to the density kit manual. The balance software includes a built-in reference density table for water at temperatures ranging from 10.0°C to 30.9 °C. Before attempting density measurements, please review this entire section thoroughly.

- In the lower portion of the home screen, select Density Determination.
- Press Tare or Zero to start weighing.
- User Help is available for review before setting up the process.

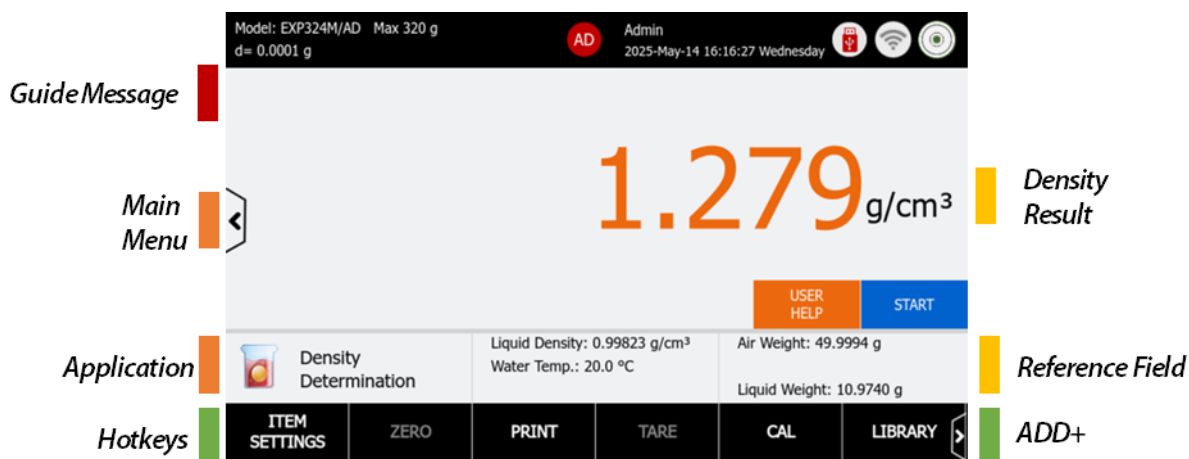

4.11.1 Application Buttons/ Reference Field

Application Button	Description
User Help	The user guide outlines the procedures for determining the density of solid materials.
Start	Press Start button to begin the process
Liquid Density	The current auxiliary liquid density value. Default setting is according to the Distilled water temperature
Water Temp.	Auxiliary liquid temperature. Default setting is according to the Distilled water temperature The water temperature range: 10-30 °C
Air Weight	The sample weight in the air
Liquid Weight	The sample weight in the auxiliary liquid
Sinker	Used for determining liquid density
Item Settings	g/cm ³ (the resolution of Density Value): <ul style="list-style-type: none"> • 0.1 g/cm³, 0.01 g/cm³, 0.001 g/cm³, 0.0001 g/cm³, 0.00001 g/cm³ Density Type: Solid , Liquid

	Liquid Type: Water , Other Liquid Porous Materials: ON/OFF Auto Print Result: Print the density result without any button Auto Sample: Auto process the sample one after the other. Auto Tare: Auto Tare: Automatic tare the container value
--	---

Note: Bold text indicates default settings.

4.11.2 The Density Result Resolution

Item	Density Resolution
g/cm ³	<ul style="list-style-type: none"> • 0.01mg balance model: 0.1g/cm³, 0.01g/cm³, 0.001g/cm³, 0.0001g/cm³, 0.00001g/cm³ • 0.1mg balance model: 0.1g/cm³, 0.01g/cm³, 0.001g/cm³, 0.0001g/cm³ • 1mg balance model: 0.1g/cm³, 0.01g/cm³, 0.001g/cm³ • 0.01g balance model: 0.1g/cm³, 0.01g/cm³ • 0.1g balance model: 0.1g/cm³
* Default settings are in bold	

4.11.3 Begin Density Determination for Solid Material

The principle of measuring the density of a solid using a balance is based on the definition of density and the measurement of mass and volume. Density is defined as the mass of an object divided by its volume.

When measuring the density of a solid, distilled water is generally used as the medium. This is because the density of distilled water is known (it reaches its maximum density of 1 g/cm³ at 4°C), and it does not chemically react with most solid materials, thus meeting the requirements of Archimedes' principle. Archimedes' principle states that when an object is fully or partially submerged in a fluid, it experiences an upward buoyant force. This buoyant force is equal to the weight of the fluid that the object displaces.

Preparation

- Set up the Density Kit on the balance, follow the instruction manual of Density Kit



- When measuring the density of a solid, distilled water is generally used as the medium. This is because the density of distilled water is known (it reaches its maximum density of 1 g/cm³ at 4°C), and it does not chemically react with most solid materials, thus meeting the requirements of Archimedes' principle that the liquid should not react with the material of the sample and should be able to completely wet the sample material.
- Press the Item Setting button to setup the Density Settings

- Confirm the following Setups are selected:
 - Density Type: Solid
 - Liquid Type: Water
 - ◆ If user use other liquid, change the liquid density in Sample Library
 - Porous Material: Off
 - Water Temperature: Change the Water temperature in Sample Library (default is 20°C)

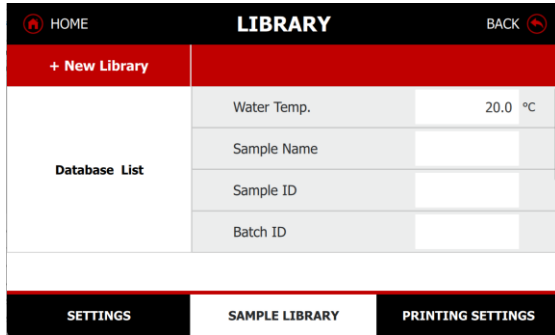

- Press BACK to return to the Density Determination home screen.
- Prepare the Sample: Ensure the solid material sample is clean and dry.
- Push the sample down into the liquid until it is fully submerged

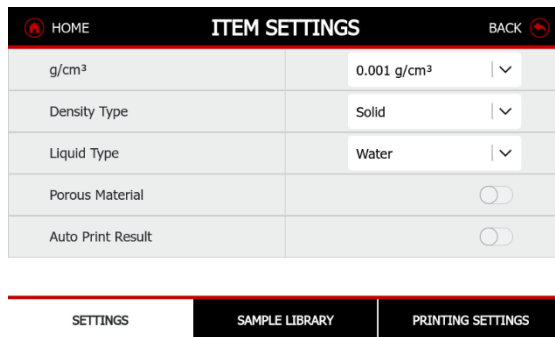

Create, Activate and Delete a library

- Press “+New Library” button to create a new library
- When a new library is created, it remains inactive. The operator has to activate the library after ticking the box.
- Press on the RUBISH BIN button to delete a library.
- After the library item is activated, the main screen will show the activated library number.

For instance, the screen below displays Library 004 as the sample utilizing the active library settings.

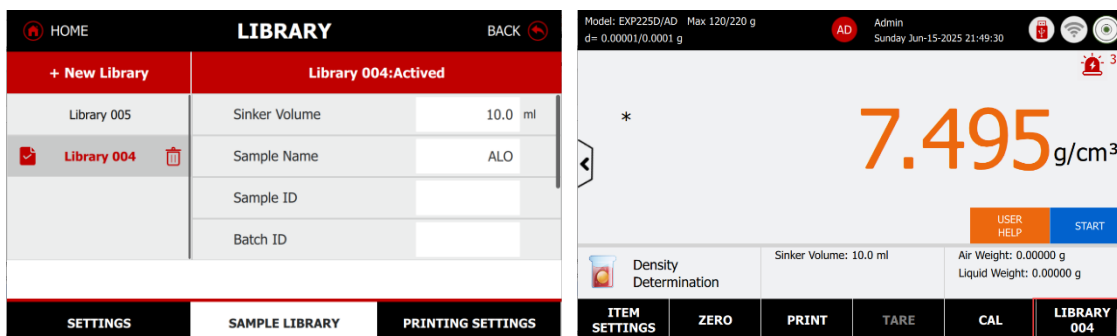

Immersion Process

- Initial Weighing: Press Start to weigh the dry material sample in air and the balance will record its mass

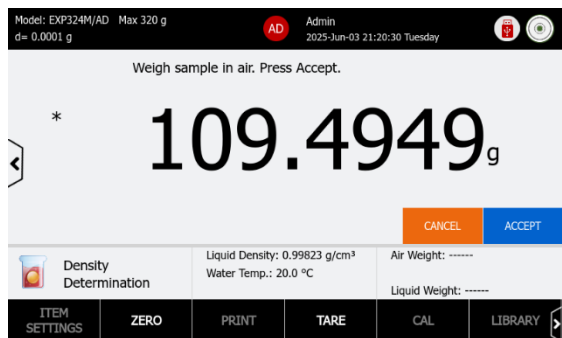

- Water Immersion: Fully submerge the sample in water, ensuring that the water fills all cavities and no bubbles are trapped.
- Weighing in Water: Press Accept button after the sample is fully saturated with water, weigh the sample again

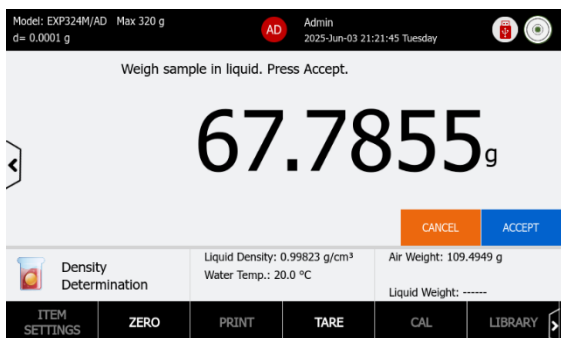

- Density Result is shown in the screen; user can print it or save it to the USB flash driver.

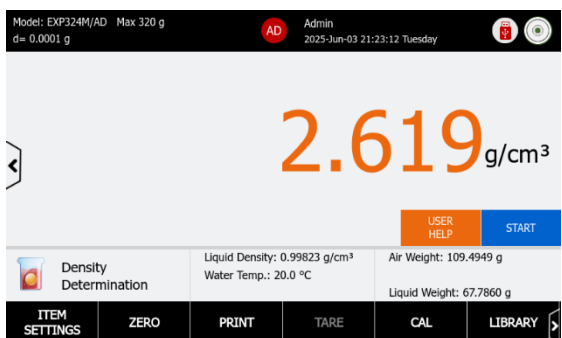

4.11.4 Begin Density Determination for Porous Material

The method of testing the density of porous materials using the oil immersion method mainly involves the following steps:

Preparation

- Setup the Density Kit on the balance, follow the instruction manual of Density Kit



- Press the Item Setting button to setup the Density Settings
- Confirm the following Setups are selected:
 - Density Type: Solid
 - Liquid Type: Water
 - Porous Material: On
 - Sample Library: Change the Oil Density (default is 0.8000 g/cm³)
 - Press BACK to return to the Density Determination home screen.

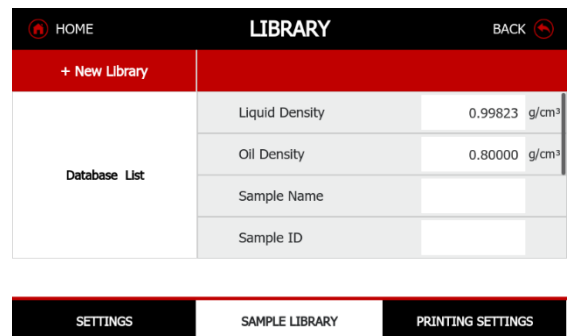

- Select Appropriate Oil: Choose an oil that has good wettability with the porous material. Commonly used oils include kerosene, light machine oil, etc.
- Prepare the Sample: Ensure the porous material sample is clean and dry.

Immersion Process

- Initial Weighing: Weigh the dry porous material sample in air and the balance will record its mass

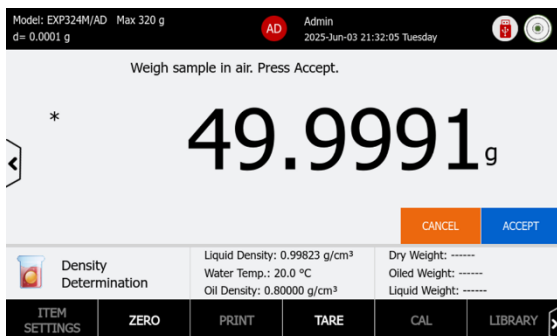

- Oil Immersion: Submerge the sample completely in the selected oil. Ensure that the oil fills all the open pores of the material. Weigh oil sample in the air and press Accept button.

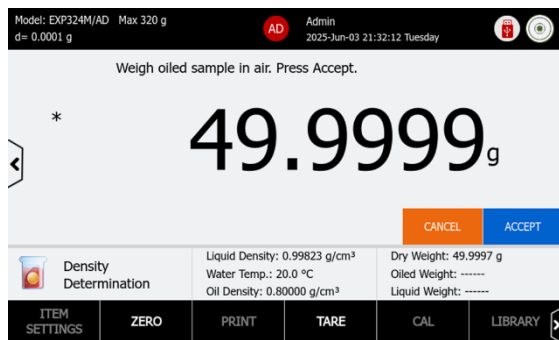

- Weighing in Oil: After the sample is fully saturated with oil, weigh the sample again while it is still submerged in the oil. Press Accept button.

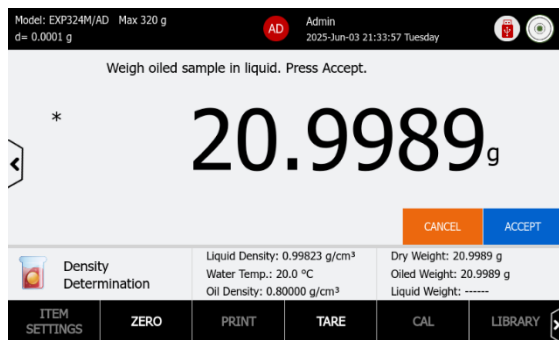

- Density Result is shown in the screen; user can print it or save it to the USB flash driver.

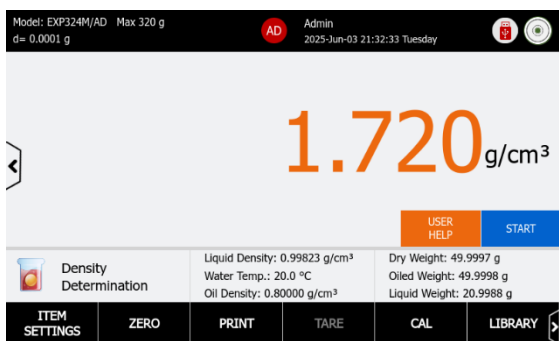

4.11.5 Begin Density Determination for Liquid Material

The principle of measuring the density of a liquid using a balance is based on Archimedes' principle and the definition of density.

Preparation

- Setup the Density Kit on the balance, follow the instruction manual of Density Kit.
- A sinker is required as it serves as a standard volume reference for determining liquid density.
- Prepare the Sample: Ensure the liquid is free of bubbles or gas.
- Setup the Sinker Volume in the Sample Library, the default setting is 10.0 ml

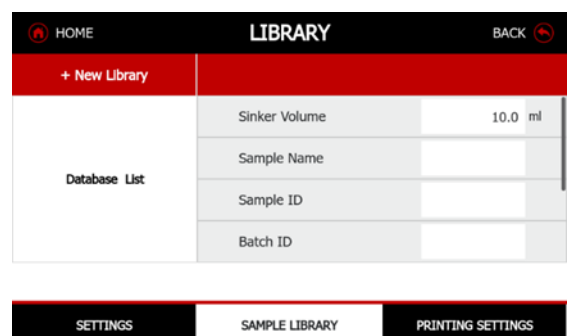

Immersion Process

- Initial Weighing: Weigh the sinker in air and the balance will record its mass. Press Accept to continue.

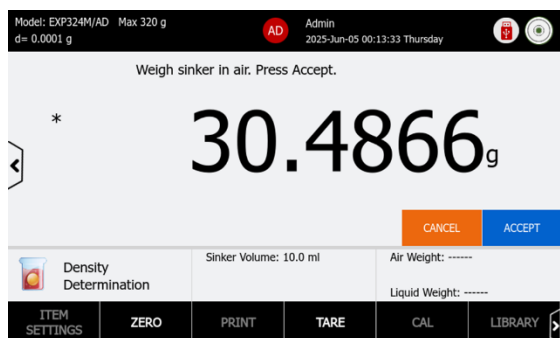

- Liquid Immersion: Submerge the sinker completely in the liquid. Press Accept to continue.

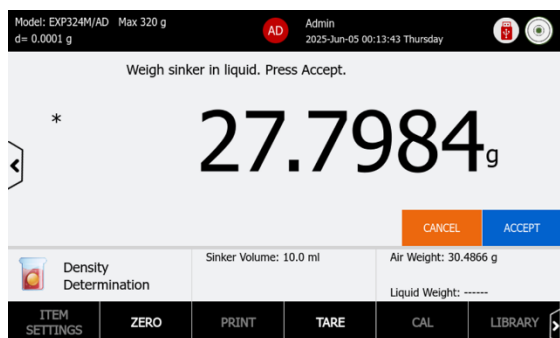

- Density Result is shown in the screen; user can print it or save it to the USB flash driver.

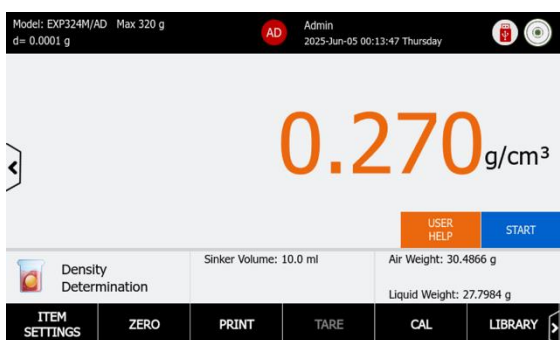

4.11.6 Sample Library – Density Determination

The Explorer Plus balance features a built-in library for managing multiple sample profiles. Up to 3,000 library records can be saved and recalled for use. The total library capacity and records are accessible across various application modes and through the library menu. When the library usage exceeds 80%, a pop-up message will alert the user to export the library or delete all items. The entire library menu, please refer to 7.0.

Create, Activate and Delete a Library

- Press “+New Library” button to create a new Library.
- When a new library is created, it remains inactive. The operator has to activate the library after ticking the box.
- Press on the RUBISH BIN button to delete a library.
- After the library item is activated, the main screen will show the activated library number.
- Example: Water Temperature is 20 °C

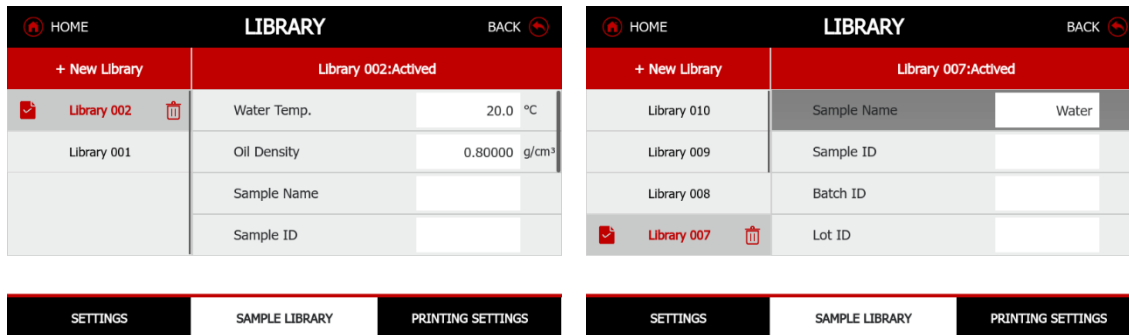

4.11.7 Print Settings

The Explorer Plus balance offers advanced print settings. Users can customize the output format and content and direct it to Excel or save it in a USB-compatible format. Additionally, users can review the print content to ensure all items are correctly selected before printing on paper or PC.

For details of Print Settings, please refer to section 6.0.

4.12 Peak Hold

This function serves to capture the maximum weight in a series of weighings.

- In the lower portion of the home screen, select Peak Hold.
- Press Tare or Zero to start weighing.
- Select the hold mode before you start the application mode

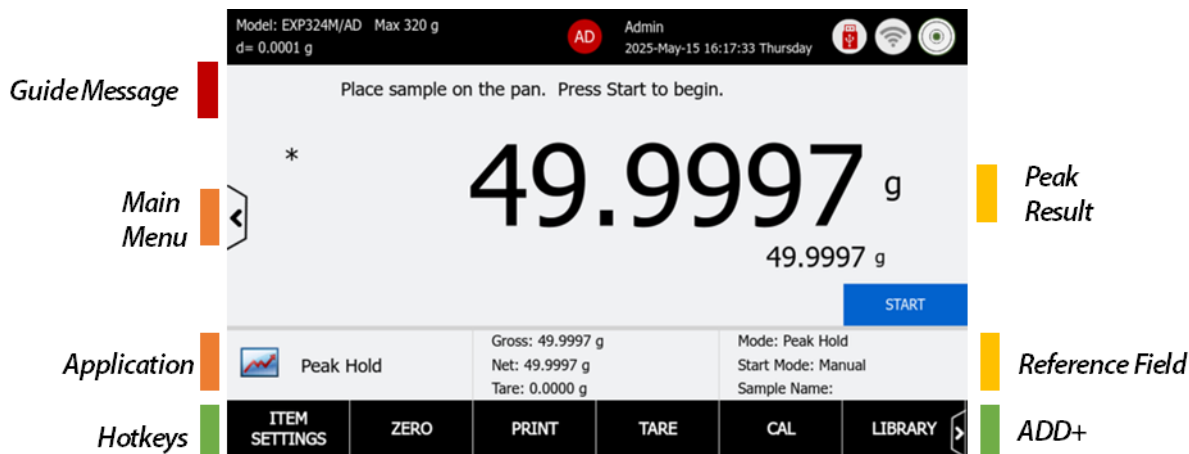

4.12.1 Application Buttons/ Reference Field

Application Button	Description
Start	Press Start button to begin the process
Mode	Peak Hold: Balance result screen will hold the highest weighing value. Display Hold: Balance result screen will hold the last weighing value.
Start Mode	Manual, Automatic
Item Settings	<ul style="list-style-type: none"> • Mode: Peak Hold, Display Hold • Start Mode: Manual, Semi-Automatic, Automatic, • Stable Weight Only: ON/OFF • Primary Weighing Unit: The default unit is grams. The operator can switch to alternative weighing units and two custom units. • Secondary Weighing Unit: able to alternative weighing units and 2 custom units • Auto Tare: Automatic tare the container value
<ul style="list-style-type: none"> • * Default settings are in bolds 	

4.12.2 Begin with Peak Hold

Step 1: Setup the Peak mode and Start Mode in the Item Settings

- Peak Mode: Select mode to Peak Hold. Peak Hold means balance will capture the maximum weight in a series of weighing.
- The user can choose the Start Mode: Manual, Semi-Automatic, and Automatic

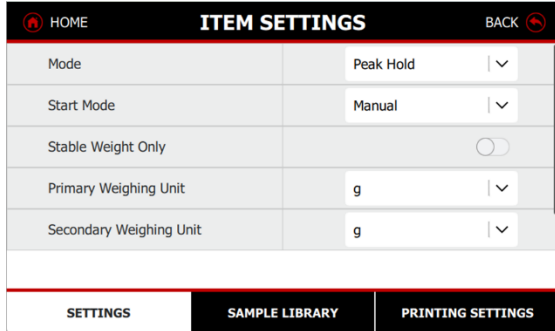

Step 2: Weigh the samples on the weighing pan

- Place a sample on the weighing pan
- Press the Start button to check the weight
- Press Stop button to restart the peak hold mode

Example: The home screen displays 27.8029 grams as the highest weight value.

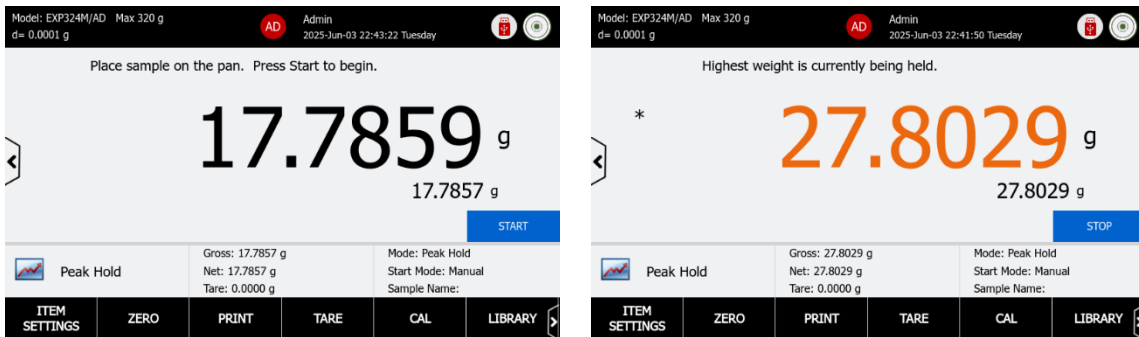

4.12.3 Begin with Display Hold

Step 1: Setup the Peak mode and Start Mode in the Item Settings

- Peak Mode: Select mode to Display Hold. Display Hold will hold the last weighing value.

Step 2: Weigh the samples on the weighing pan

- Place a sample on the weighing pan
- Press the Hold button to record the last weight.
- Press Cancel button to restart the display hold mode

Example: The home screen displays 20.4742 grams as the last weight value.

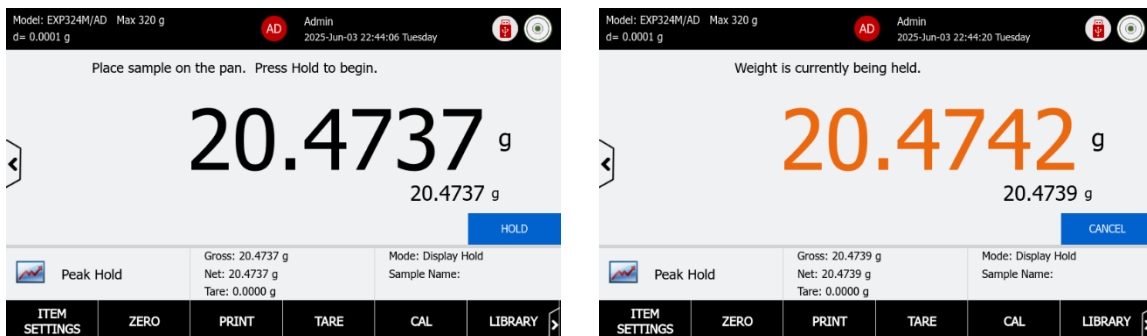

4.12.4 Sample Library – Peak Hold

The Explorer Plus balance features a built-in library for managing multiple sample profiles. Up to 3,000 library records can be saved and recalled for use. The total library capacity and records are accessible across various application modes and through the library menu. When the library usage exceeds 80%, a pop-up message will alert the user to export the library or delete all items. The entire library menu, please refer to 7.0.

Create, Activate and Delete a Library

- Press “+New Library” button to create a new Library.
- When a new library is created, it remains inactive. The operator has to activate the library after ticking the box.
- Press on the RUBISH BIN button to delete a library.
- After the library item is activated, the main screen will show the activated library number.
- Example: Sample Name is Parts.

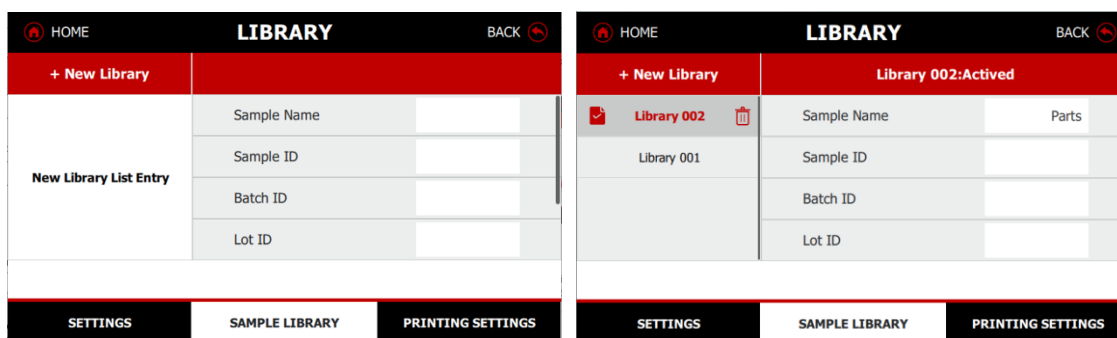

4.12.5 Print Settings

The Explorer Plus balance offers advanced print settings. Users can customize the output format and content and direct it to Excel or save it in a USB-compatible format. Additionally, users can review the print content to ensure all items are correctly selected before printing on paper or PC.

For details of Print Settings, please refer to section 6.0.

4.13 Pipette Adjustment

This function serves to calculate the inaccuracy and imprecision of pipettes, used to check if a pipette's dosage is within tolerances. This application is designed for the Explorer Plus Semi-Micro, Analytical, and Precision models. The High-capacity model is not applicable.

- In the lower portion of the home screen, select Pipette Adjustment
- Press Tare or Zero to start weighing.
- Create Test Method before you start the application mode

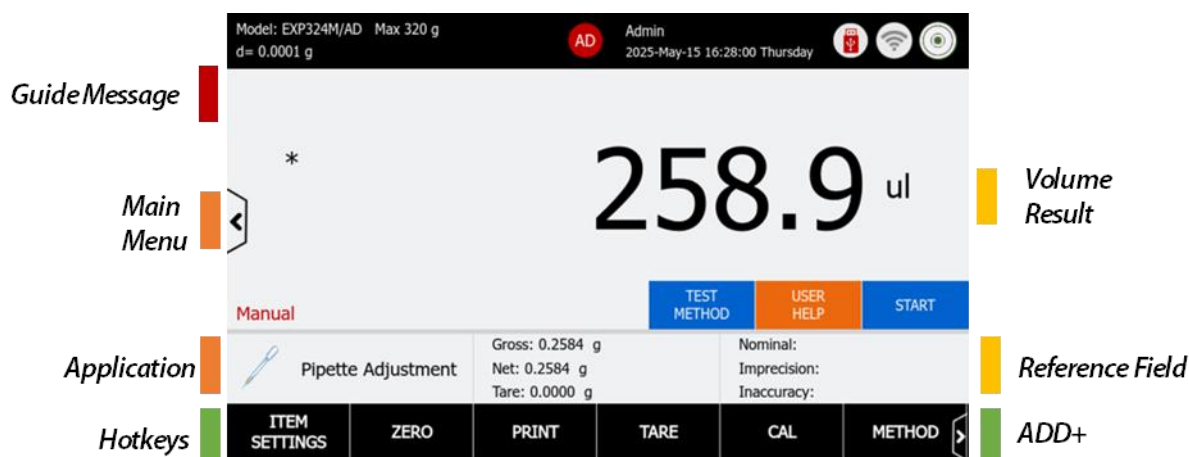

4.13.1 Application Buttons/ Reference Field

Application Button	Description
TEST METHOD	Set up Test Methods. A Test Method must be selected to start the test.
USER HELP	View user help instructions.
START	Before starting the pipette test, the user must first create the pipette method. Without a pipette method, the START button will be disabled.
Nominal	The volume that a pipette is calibrated to deliver or measure. For example: A 10-milliliter pipette has a nominal volume of 10 milliliters.
Imprecision %	The percentage variation in repeated measurements, indicating the consistency of results.
Inaccuracy %	The percentage deviation from the correct volume that a pipette delivers
Item Setting	Auto Process: Automatically tare the last dispense value Volume Units: microliter (µL), milliliter (mL) Liquid Type: Water and others Liquid Density: 0.99823 g/cm ³ (default) Barometric: ATM (Atmospheres), inHg (Inches of Mercury). kPa (Kilopascals), mbar (Millibars), mmHg (Millimeters of Mercury), PSIA (Pounds per Square Inch Absolute).

4.13.2 Create Method

The balance permits users to configure up to 25 methods for pipette calibration. The pipette test method necessitates the entry of six primary parameters. However, the pipette name and number are optional fields.

- Nominal: The volume that a pipette is calibrated to deliver or measure.
- Pipette Name
- Pipette Number
- Inaccuracy (%): The percentage deviation from the correct volume that a pipette delivers, typically specified in the pipette's technical documentation.
- Imprecision (%): The percentage variation in repeated measurements, indicating the consistency of results, typically specified in the pipette's technical documentation.
- Number of Samples in a method: 6-10 (10 samples are preferred by ISO8655)

Step 1: Create numbers for the TEST METHOD.

- Press the TEST METHOD button on the main screen to create a new test method.
- Activate this method by clicking the checkbox before editing.
- Note: To create additional test methods, press the NEW button to increment the count.

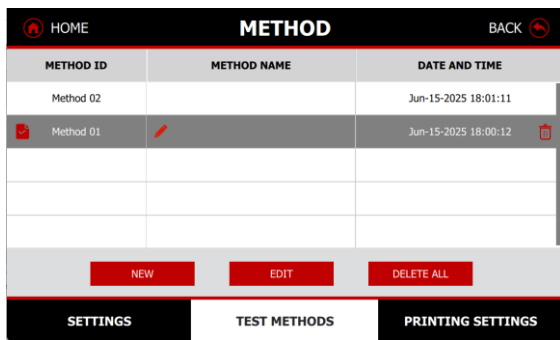

Step 2: Press EDIT button to create a detailed pipette testing criterion.

- Tap the “ADD NEW” button to enter the detailed test technical specifications. A maximum of 5 capacity data entries can be stored within a single method.
- Press Save to exit the METHOD screen.
- Note: To delete a method, click the “trash bin” button. To edit the data, click the “pen” button.

Step 3: Press START button to start the process

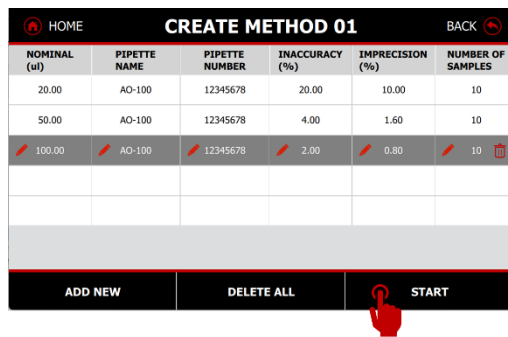
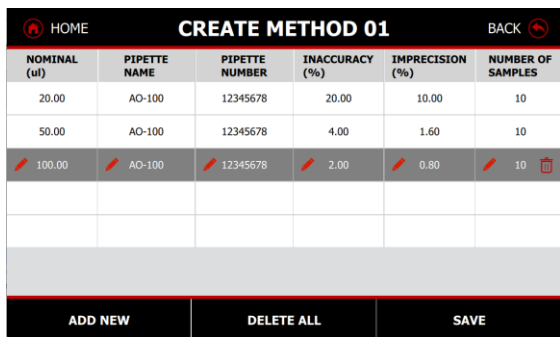

4.13.3 Start Pipette Adjustment

Install a Pipette Kit

Prior to commencing the pipette adjustment process, it is essential to install a Pipette Kit to prevent liquid evaporation. The Pipette Kit accessory item number in section 11.5.



Test Liquid

Distilled or deionized water of grade 3, as specified in ISO 3696, shall be used. The water should be degassed or air equilibrated.

Ambient Conditions

The test must be conducted in a draft-free room with a stable environment. The test room should maintain a relative humidity above 50% and a constant temperature (± 0.5 °C) within the range of 15 °C to 30 °C. Prior to the test, the apparatus to be tested and the test water shall have been acclimated to the room conditions for a sufficient period, not less than 2 hours, to achieve equilibrium.

Step 1: Press the START button to begin the process

- Tare the weight of Pipette Kit or another container on the pan.
- Dispense Sample 1 into the container. Subsequently, press the ACCEPT button to record the value.
- Follow the instructions to dispense the next sample.
- Continue step 3 until all samples are dispensed.

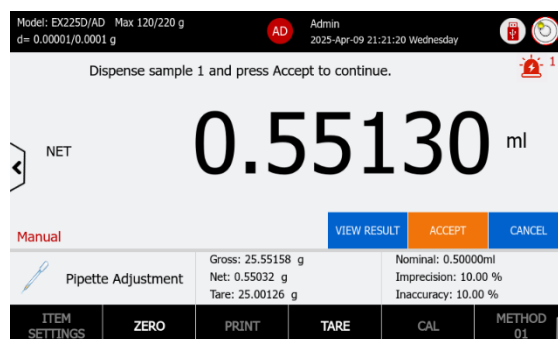
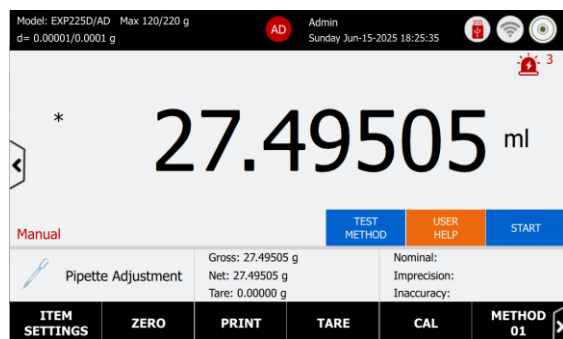

4.13.4 View Result

Press VIEW RESULT button to view the formulation results once the process has finished.

PIPETTE ADJUSTMENT RESULT					
NOMINAL (ml)	PIPETTE NAME	PIPETTE NUMBER	INACCURACY (%)	IMPRECISION (%)	STATUS
0.50000	PPE1	LDUA001	E%: 7.11 % E% Limit: 10.00 % Average:0.53556 ml	CV%: 4.90 % CV% Limit: 10.00 % Std:0.02624 ml	Pass
2.00000	PPE2	LDUA002	E%: 6.73 % E% Limit: 10.00 % Average:2.13460 ml	CV%: 2.46 % CV% Limit: 10.00 % Std:0.05258 ml	Pass

VIEW RESULT
PRINT RESULTS
DELETE ALL
EXPORT TO PDF

4.13.5 Print Settings

The Explorer Plus balance offers advanced print settings. Users can customize the output format and content and direct it to Excel or save it in a USB-compatible format. Additionally, users can review the print content to ensure all items are correctly selected before printing on paper or PC.

For details of Print Settings, please refer to section 6.0.

4.14 Statistical Quality Control (SQC)

SQC is used to monitor and maintain product quality in various industries, including food, pharmaceuticals, and manufacturing. In the balance, this function serves to is used to determine the homogeneity of items in a batch and batches over time.

- In the lower portion of the home screen, select SQC
- Press Tare or Zero to start weighing.
- Create Batch Setting before you start the application mode

4.14.1 Application Buttons/ Reference Field

Reference Fields	Description
Samples	Numbers of the quality control products
+T1>N>-T1: 0, 0.00%	Statistics of samples that lie between +T1 and -T1.
+T2>N>-T2: 0, 0.00%	Statistics of samples that lie between +T2 and -T2.

4.14.2 Acceptance Criterion

SQC Result	Description
Lot Accepted	<p>The lot will be considered accepted when all conditions are met:</p> <p>The average weight of samples must be greater than the nominal weight.</p> <p>The defective sample¹ number in the 1st samples is less than or equal to the 1st acceptance criterion.</p> <p>If the defective samples number lies between the 1st Acceptance and Rejection criterion, a 2nd sample should be tested.</p> <p>The lot will be considered accepted when all conditions are met:</p> <p>The average weight of aggregated samples must be greater than the nominal weight.</p> <p>The aggregated defective samples number is less than or equal to the 2nd acceptance criterion.</p>
Lot Rejected	<p>The lot will be rejected when any of the condition is met:</p> <p>if any of the sample weight is not greater than the -T2 limits;</p> <p>Defective sample number is equal to or greater than Rejection criterion.</p> <p>The average weight of samples is less than the nominal weight</p>

Note: 1 Defective sample are samples with a weight that lies between -T1 and -T2.

4.14.3 Inspection Sample Number and Criterion Table

Lot Piece Number	Samples			Number of defective samples	
	Order	Number	Aggregated Number	Acceptance criterion	Rejection criterion
100 to 500	1 st	30	/	1	3
	2 nd	30	60	4	5
501 to 3200	1 st	50	/	2	5
	2 nd	50	100	6	7
3201 and over	1 st	80	/	3	7
	2 nd	80	160	8	9

4.14.4 Tolerance

- When EU Criteria is set On, -T1 and +T1 are determined based on the target according to the below table. -T2 and +T2 are the value twice of -T1 and +T1.
- When EU Criteria is set Off, -T1, -T2, +T1, and +T2 values can be customized by the users. Samples with a weight that lies between -T1 and -T2 are determined as defective.

TARGET IN GRAMS OR IN MILLILITRES	-T1 / +T1 TOLERANCE ON THE TARGET	
	in %	in g or ml
From 5 to 50	9	-
From 50 to 100	-	4,5
From 100 to 200	4,5	-
From 200 to 300	-	9
From 300 to 500	3	-
From 500 to 1000	-	15
From 1000 to 10000	1,5	-
From 10000 to 15000	-	150
Beyond 15000	1	-

4.14.5 Create Batch

To create a new batch, the user must configure the parameters prior to commencing the weighing of batch samples. Press "ITEM SETTING", the batch options are following.

- ****Numbers in Batch:**** The balance will automatically recommend the inspection sample size based on the total number of samples.
 - Total Sample is from 100 to 500 units (need inspect 30 samples)
 - Total Sample is from 501 to 3200 units (need inspect 50 samples)
 - Total Sample is equal or great than 3201units (needs inspect 80 samples)
 - 100% inspection: the user can define specific inspection sample numbers
- Tare Mode: Off/ Pretare. When the user selects the Pretare, the value can input by keyboard
- Sample Type: Solid/Liquid. When the user selects "Liquid," the density of the liquid must be entered.
- EU Criteria: On/ Off
 - When it's on, the SQC process refers the EU Council Directive 76/211/EEC
 - ◆ Council Directive 76/211/EEC is a European directive adopted on January 20, 1976, aimed at harmonizing the laws of the Member States regarding the prepackaging of products by weight or volume. The directive seeks to ensure that prepackaged products are accurately labeled and meet certain quality standards to protect consumers and facilitate trade within the European Union.
- Nominal Weight: Set the value of nominal target weight in grams or milliliters.
- +T1, -T1, +T2, -T2 Setting
- Sample Name
- Batch Name

- Lot ID
- Project Name
- 10 x Customized ID

Note: The Batch Library can store up to 25 records, the user has to activate the selected batch to start the process.

Step 1: Create a Batch

- Press the +New Batch button to create a batch parameter.
- Activate the new batch by clicking the checkbox

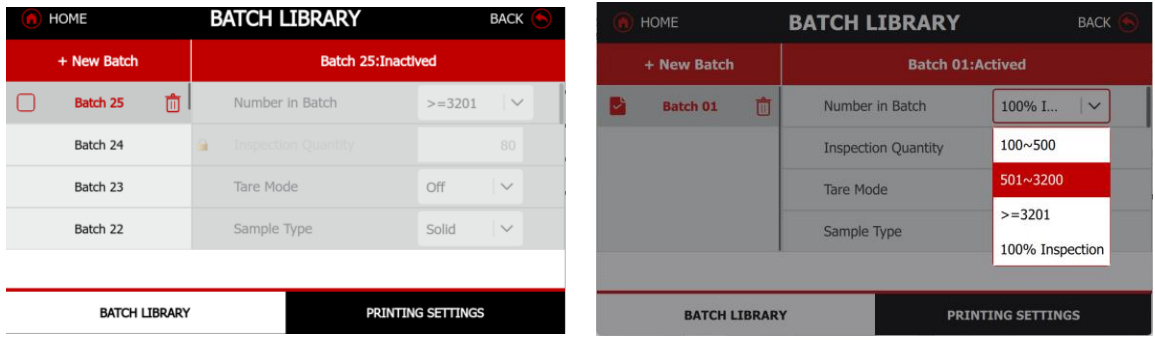

Step 2: Create, Activate and Delete a Batch

- Press “+New Batch” button to create a new batch
- When a new batch is created, it remains inactive. The operator has to activate the library after ticking the box.
- Press on the RUBISH BIN button to delete a batch.
- After the batch item is activated, the main screen will show the activated batch number.

Example: In the below screen, it shows BATCH 25 as the active batch parameter.

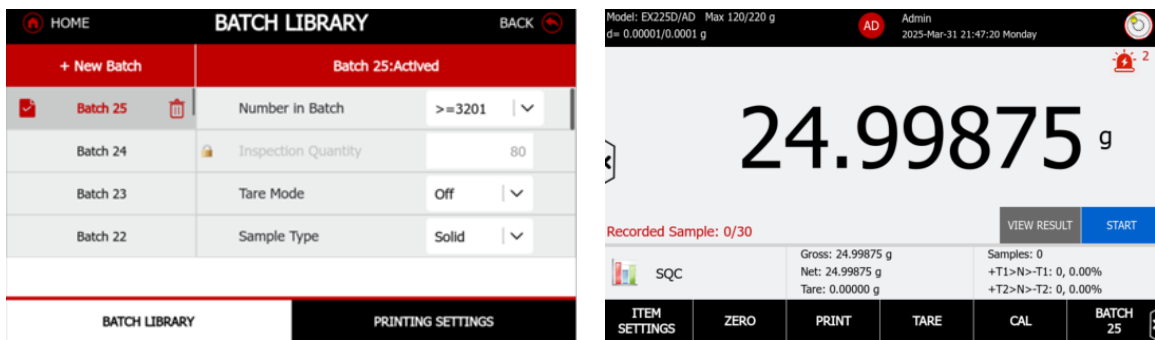

Notes:

- To delete a batch, click the “trash bin” button.
- To create additional test methods, press the NEW button to increment the count.

4.14.6 Begin the SQC Process

Step 1: Create batch parameter

- Press the start button to begin the process, the balance will require the user to create a batch.

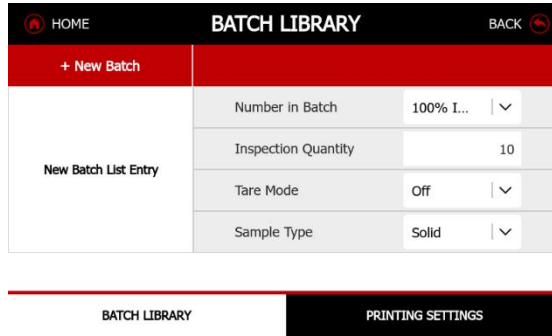
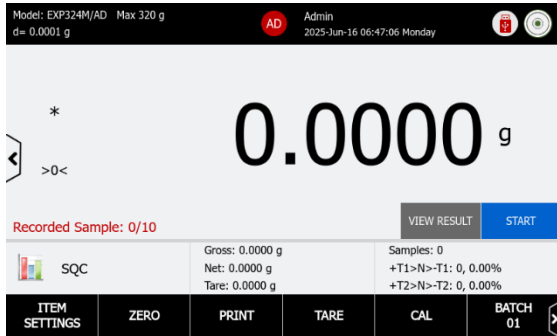

- Click the "+NEW BATCH" button to set up the batch parameters. The user must confirm the parameters before exiting the batch library step.

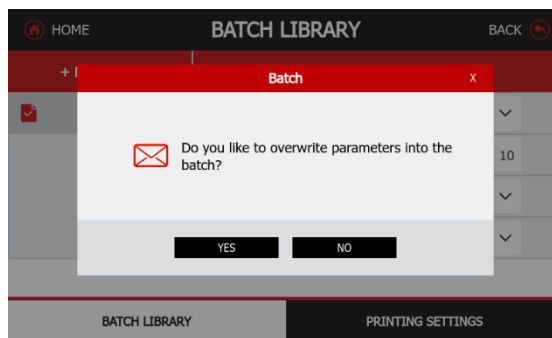
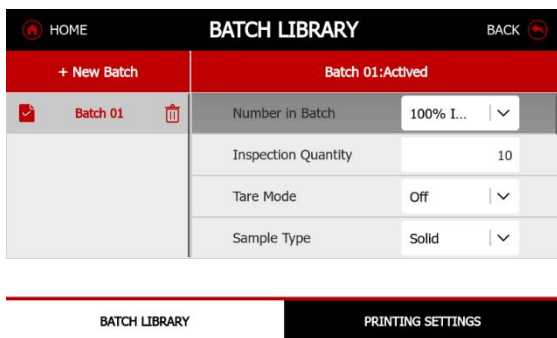

Step 2: Start the process

- Remove the container or sample from the pan, press start to weight series samples.

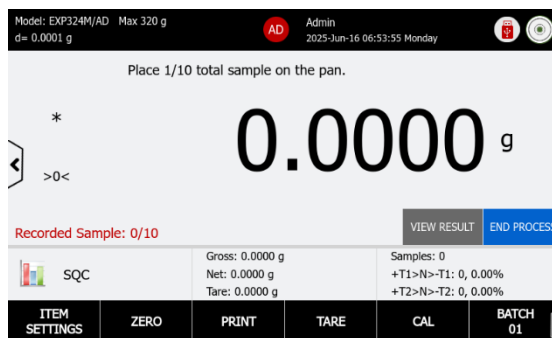
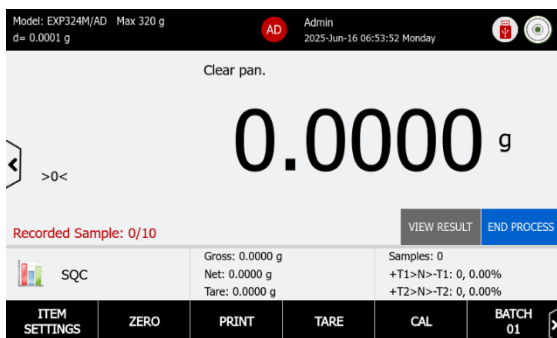

- Weigh 10 samples in a single run, following the on-screen guide messages.

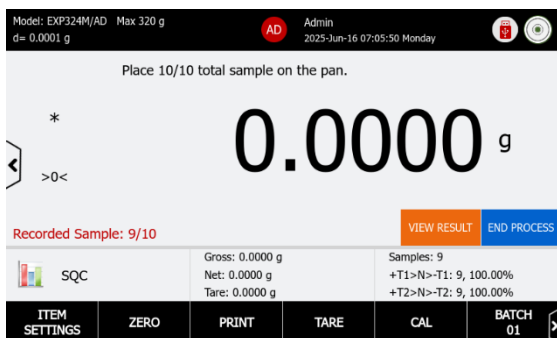

Example, if the user defines 100% inspection, the number of samples are 10 units, the sample sequence label will display "Recorded Sample 0/10" in the field area to indicate the current sample number.

Note: The Explorer Plus balance can store up to 5 unfinished batches. By simply switching the Batch ID, the process will record the last sample in the batch and continue with the remaining sample weighing process.

Note: When the tolerance exceeds the acceptance criteria during the process.

When the sample weight exceeds the acceptance limit set in the batch parameters, the balance will alert the user that the process requires double sample units testing or will terminate the SQC process.

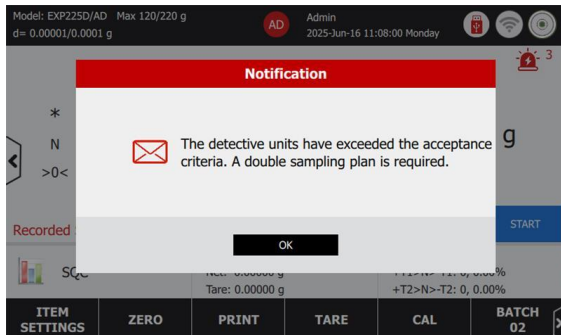

Step 3: View Result Print Statical Data.

After the process is done, the Result screen will automatic pop up.

Click VIEW GRAPHICS button to presents the data statistic graphic views.

Note: If the user end process in the middle of the process, press VIEW RESULT button to review the data.

#	BATCH NUMBER	SAMPLE ID	WEIGHT (g)	T1/T2
001	01	Sample 001	14.1825	>=-T1 & <+T1
002	01	Sample 002	14.1824	>=-T1 & <+T1
003	01	Sample 003	14.1823	>=-T1 & <+T1
004	01	Sample 004	14.1821	>=-T1 & <+T1

Result: Reject

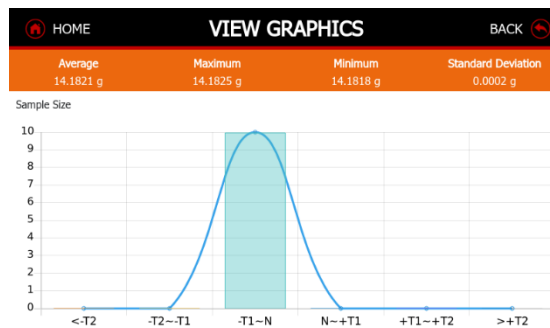

4.14.7 Print Settings

The Explorer Plus balance offers advanced print settings. Users can customize the output format and content and direct it to Excel or save it in a USB-compatible format. Additionally, users can review the print content to ensure all items are correctly selected before printing on paper or PC.

For details of Print Settings, please refer to section 6.0.

4.15 Fill Weight Variation

This function serves to assess the uniformity of the weight of material dispensed into a container or mold throughout the manufacturing process.

- In the lower portion of the home screen, select Fill Weight Variation
- Press Tare or Zero to start weighing.
- Setup the Sample Average Weight, \pm Limits before you start the application mode

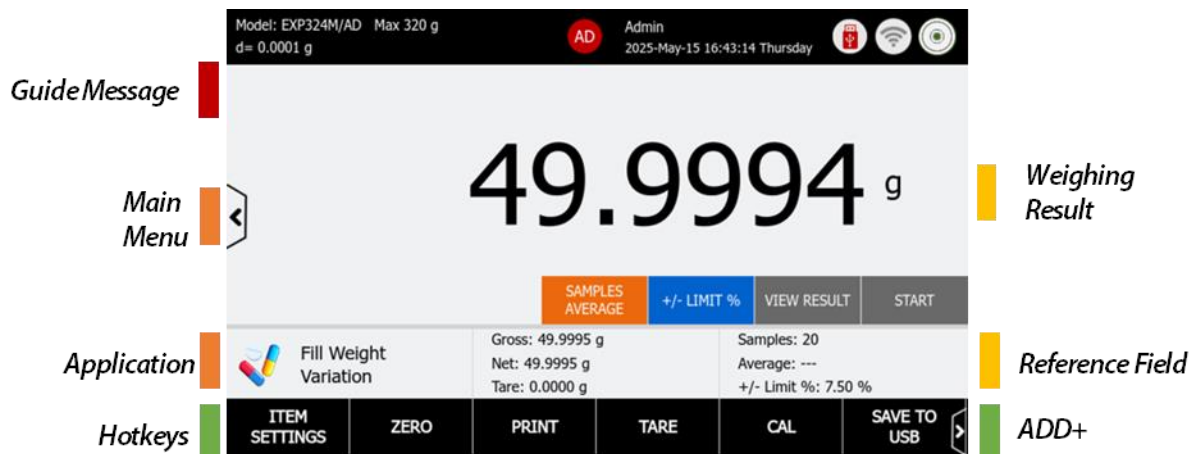

4.15.1 Application buttons/ Reference Fields

Application Button	Description
SAMPLES AVERAGE	Calculate the average sample average weight button.
+/- LIMIT %	<ul style="list-style-type: none"> • Customized average piece weight limitation for the samples • When Acceptance Criteria is set to USP <2091> mode, the limits have been settling according to USP <2091>
VIEW RESULT	Press this button to view the sample results once the process has finished.
START	Press Start button to begin the process
Item Settings	<ul style="list-style-type: none"> • Primary Weighing Unit: The default unit is grams. The operator can switch to alternative weighing units and two custom units. • Auto Process: Automatically tare the last sample value • Acceptance Criteria: OFF/ USP <2091>

Notes: USP <2091> WEIGHT VARIATION OF DIETARY SUPPLEMENTS

The following tests provide limits for the permissible variations in the weights of individual tablets, capsules, or chewable gels expressed in terms of the allowable deviation from the average weight of a sample. Separate procedures and limits are described herein for capsules, uncoated tablets, coated tablets, and chewable gels that are intended for use as dietary supplements. Weblink: [\(2091\) Weight Variation of Dietary Supplements](#)

4.15.2 Begin the Fill Weight Variation

Step 1: Setup the Acceptance

There are two ways to setup the acceptance criteria, one is direct input limit the application main screen

- Press +/- LIMIT % button to establish the customized limitation for the average weight

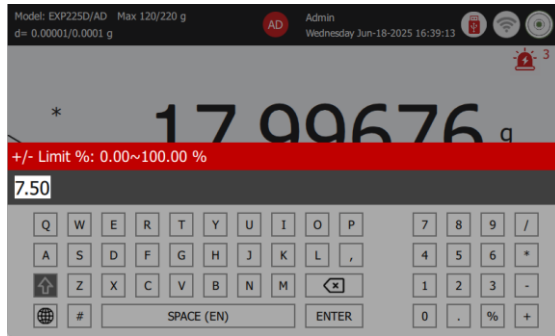
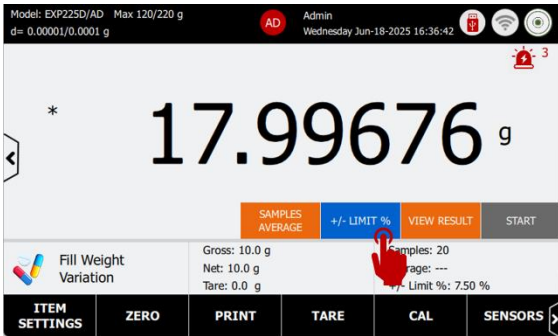

- Press the Item Settings button to change the Acceptance Criteria. The user can select set Acceptance Criteria to USP <2091>. When Acceptance Criteria is set to USP <2091> mode, the limits have been settling according to USP <2091>

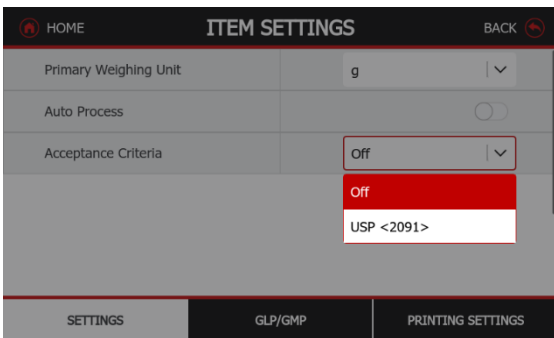

Step 1: Sample Average Weight

- Press SAMPLE AVERAGE button to establish the sample average weight

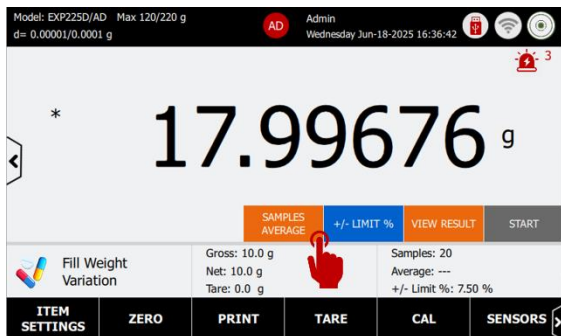

- Enter the total number of samples. (A minimum of 20 samples is recommended.) And then place samples on the pan to calculate the average weights

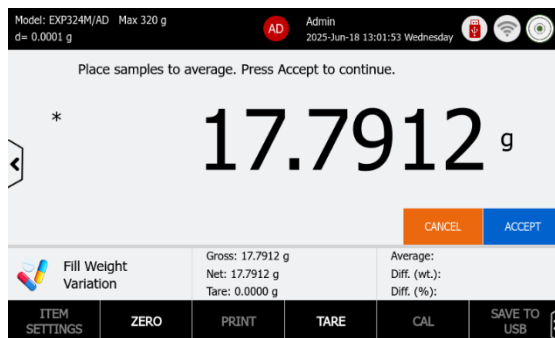
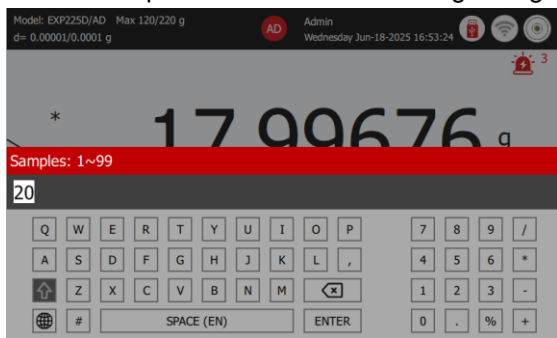

Example: The below screenshot shows the average weight is 0.8896 g.

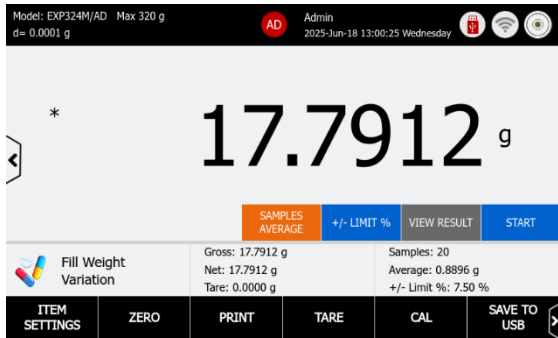

- Press the Item Settings button to change the Acceptance Criteria. The user can select set Acceptance Criteria to USP<2091>

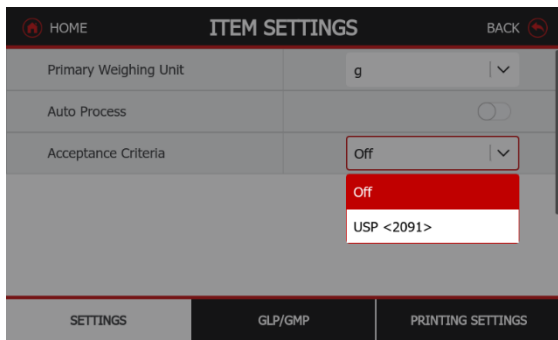

Step 3: Start the Process

- Tare the balance before starting the process.
- Press START button to weigh series samples, place sample 1 on the pan.
- Press ACCEPT button to record the weight in the balance
- Continue this process until all the samples are being weight.

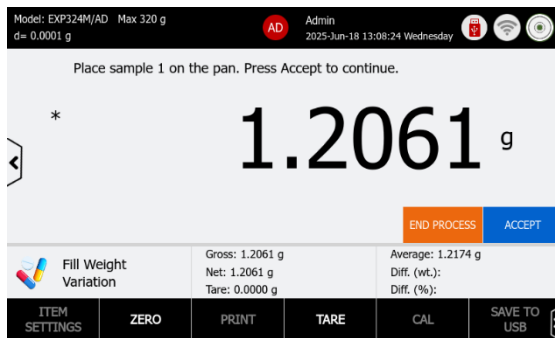
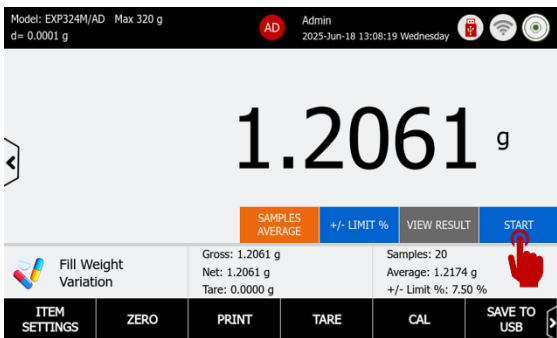

Step 4: Result

After all the samples are being weight, the screen will automatically go to VIEW RESULT.

The result information is including:

- Sample Size, Individual sample weight, Accept units, Fail units, Average weight and +/- LIMIT %
- The user can print the result using a printer or a PC and save the result in PDF format.

Example: The table below shows the result based on 20 samples, and 20 units are accepted according to limitation +/- 7.5%.

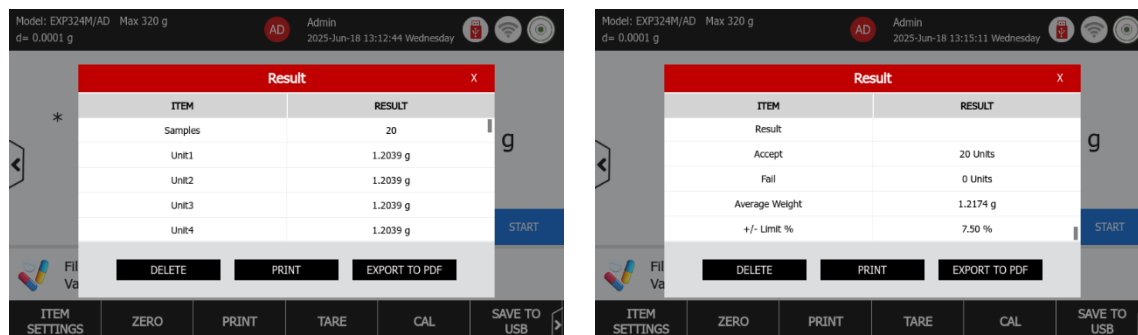

4.15.3 Sample Information – Flow Rate Control

The flow rate control application, the sample information can be setup in GLP/GMP menu. The user can enter the Sample Name, Sample ID, Batch ID, and Lot ID. Press NEW button to add additional 10 customized IDs.

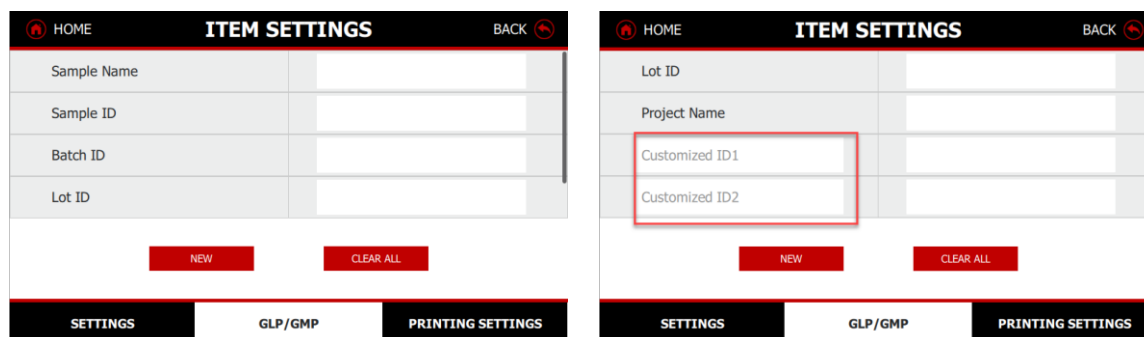

4.15.4 Print Settings

The Explorer Plus balance offers advanced print settings. Users can customize the output format and content and direct it to Excel or save it in a USB-compatible format. Additionally, users can review the print content to ensure all items are correctly selected before printing on paper or PC.

For details of Print Settings, please refer to section 6.0.

4.16 Flow Rate Control

Flow rate is a measure of the volume of fluid that passes through a given cross-sectional area per unit of time. It is a critical parameter in fluid dynamics and is used in various applications, from medical infusions to industrial processes. The flow rate can be calculated using different formulas depending on the context and the available information.

In the Explorer Plus balance, this function serves aims at managing the volume or mass of fluid (liquid or gas) that passes through a pump system over a specific period.

- In the lower portion of the home screen, select Flow Rate Control
- Press Tare or Zero to start weighing.
- Setup the Infusion Time, Pump Speed before you start the application mode

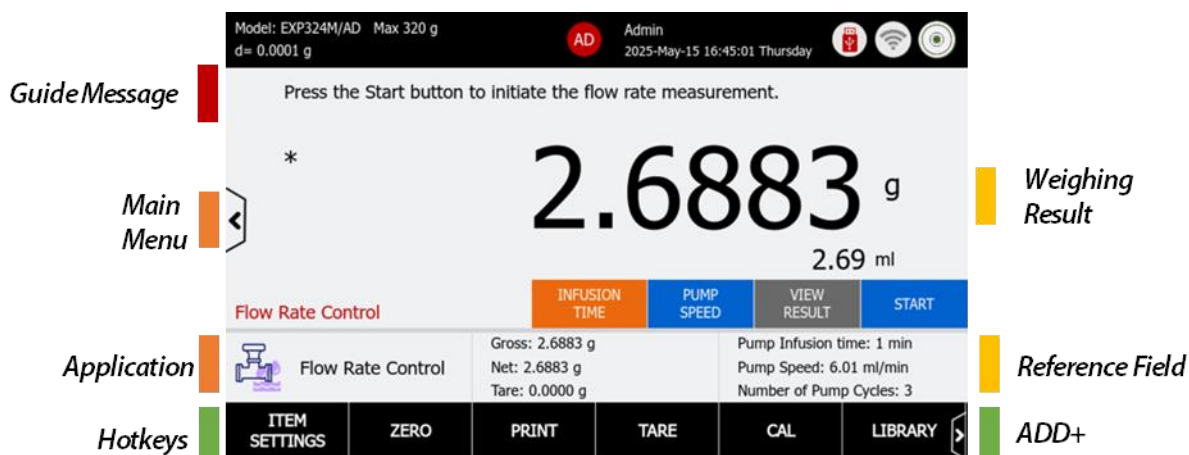

4.16.1 Application Buttons/ Reference Field

Application Button	Description
INFUSION TIME	Pump infusion time refers to the duration required for an intravenous (IV) infusion pump to deliver a specific volume of fluid.
PUMP SPEED	Input the pump speed
VIEW RESULT	Press this button to view the formulation results once the process has finished.
START	Start the flow rate calculation process
Numbers of Pump Cycles	Refers to the total number of complete operational cycles a pump performs.
Item Settings	Mode: Flow Rate Control/ Target Control Pump Speed: g/min, mL/s, mL/min, µL/s, µL/min Audible Signal: ON/ OFF

4.16.2 Flow Rate Control Setting

Step 1: Setup the Control Mode

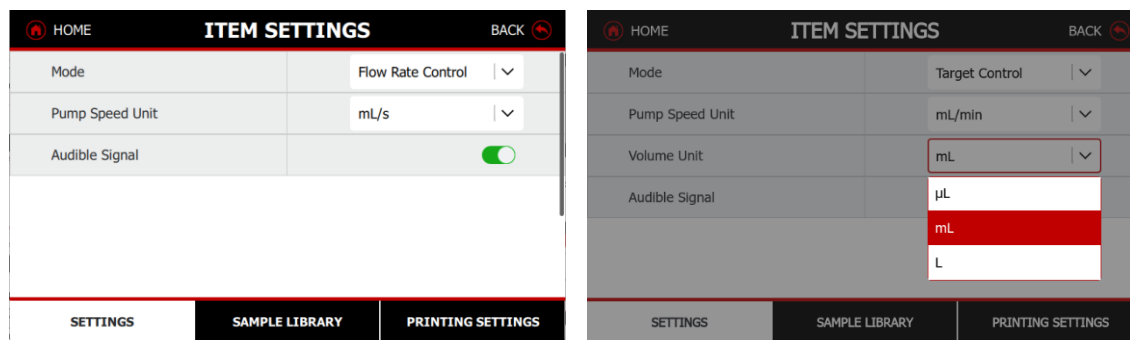

- Flow Rate Control
 - Flow Rate Control mode is to capture and calculate the average volume or mass of fluid (liquid or gas) that passes through a pump system over a specific period.
 - When the user selects “mL/ s”, “mL/min”, “µL/ s” and “µL/ min” as pump speed units, the volume Flow Rate Formulation is:

$$Volume\ Flow\ Rate = \frac{End\ Weight - Start\ Weight}{Liquid\ Density} / Infusion\ Time$$

- When the user selects “g/ min” as pump speed units, the Flow Rate Formulation is:

$$Mass\ Flow\ Rate = \frac{End\ Weight - Start\ Weight}{Infusion\ Time}$$

- Target Control
 - The Target Control mode is to test whether the output of the pump each time is consistent with the target weight, with the aim of determining the actual average output speed of the pump.
 - The Formulation is:

$$Target\ Control\ Flow\ Rate = \frac{End\ Weight - Start\ Weight}{Liquid\ Density} / End\ Time$$

Step 2: Setup the Pump Speed Unit

- Before starting the process, the user should input the infusion time and select the pump speed unit.

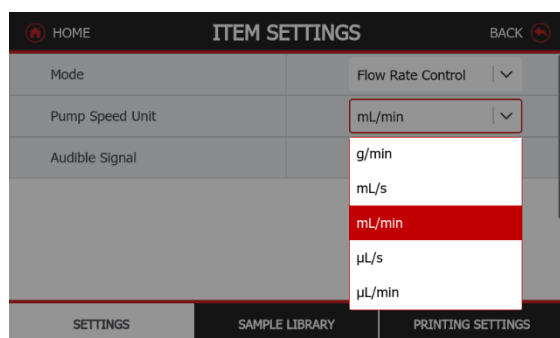

Step 3: Audible Signal

If the user requires a voice alert when the pump cycle is completed, they can enable the "Audible Signal" menu option.

Step 4: Create Pump Profile

- Press SAMPLE LIBRARY button to set up the pump profile, e.g. Pump Speed, Liquid Density, Pump Time, Number of Pump Cycles.
- On the main screen, users can configure both infusion time and pump speed using the available buttons.

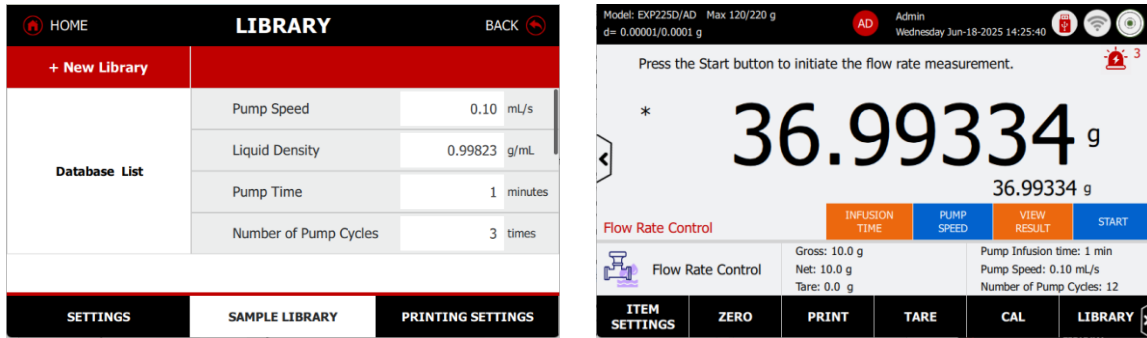

Step 5: Preparation and Start the Process

- After connecting the tubing to the laboratory micro pump, insert one end into a test tube bottle. Then, place the test tube into a container and put it on a balance.
- Tare the balance before starting the process.



4.16.3 Begin the Flow Rate Control

Step 1: Start the process

- Before starting the process, the user should input the infusion time and select the pump speed unit in ITEM SETTINGS
- Press **START** button to pump the first cycle to the test tube according to your Pump Profile setting. The balance will calculate the average weighing result for this cycle of liquid. After remaining time, pump the second cycle to test tube. The balance will calculate the average weighing result for this cycle of liquid.

Example: The screenshot below shows that the balance has calculated the first average weighing result within a 1-minute reminder period.

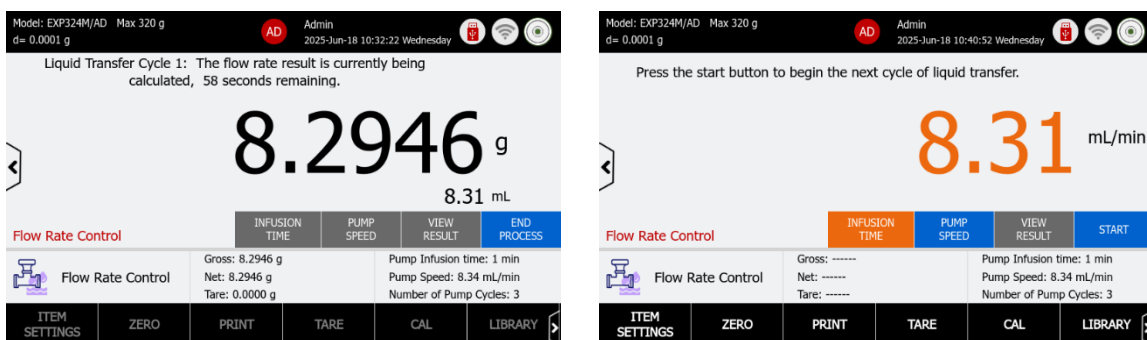

Step 2: Initiate the second pump output

- Press START button to pump the second cycle to the test tube. The balance will calculate the average weighing result for this cycle of liquid in remaining time.
- Continue this process until all the pump cycle has been captured and calculated.

Example: The screenshot below shows that the balance has calculated the second average weighing result within a 1-minute reminder period.

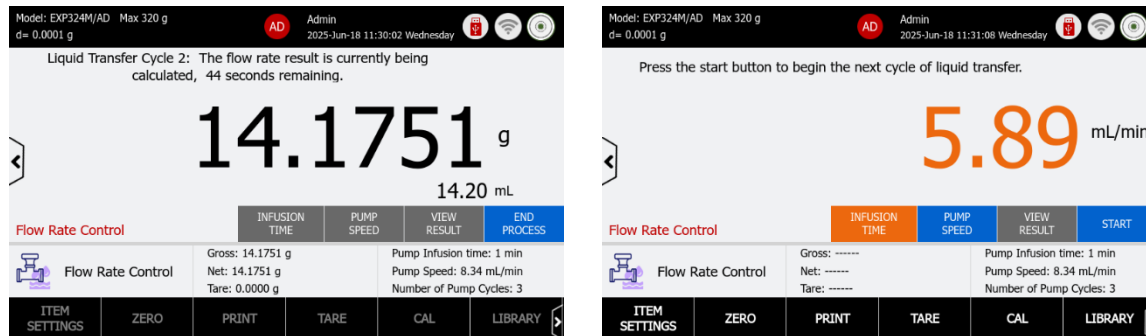

Step 3: View Result

After all the cycle is completed, the screen will automatically go to VIEW RESULT.

The result information is including:

- Pump Speed, Max Flow Rate, Min Flow Rate, Average Flow Rate and Number of Pump Cycles
- Example: The graphic below shows the result based on 12 times pump cycle testing, the average pump speed is 21.04 mL/ min
- The user can print the result using a printer or a PC and save the result in PDF format. The graphic chart cannot be saved on any storage device.



4.16.4 Begin the Target Control Mode

Step 1: Start the process

- Before starting the process, the user should input the target volume and select the pump speed unit and volume unit in ITEM SETTINGS.

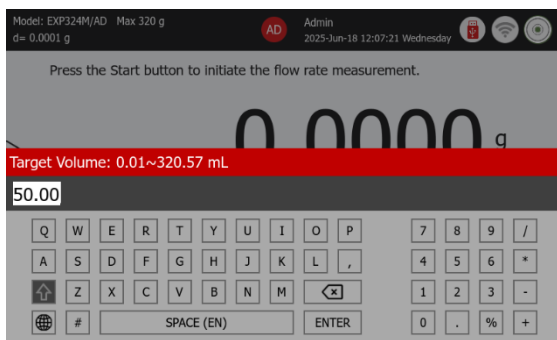
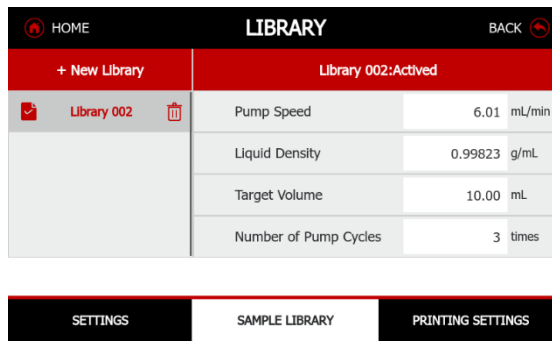
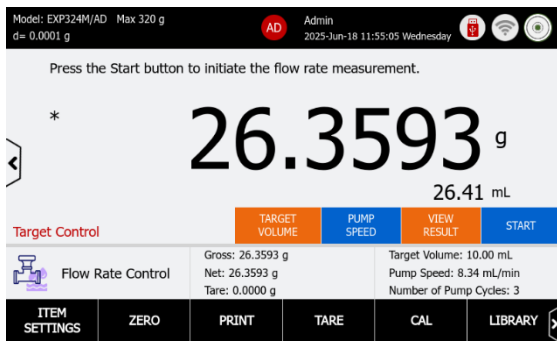

- Press START button to pump the liquid to the test tube when the volume is close to the target volume, the screen will capture the result.

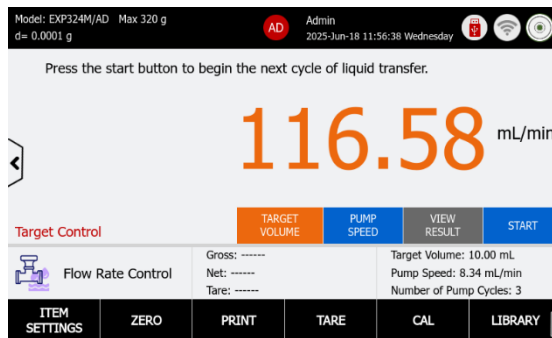
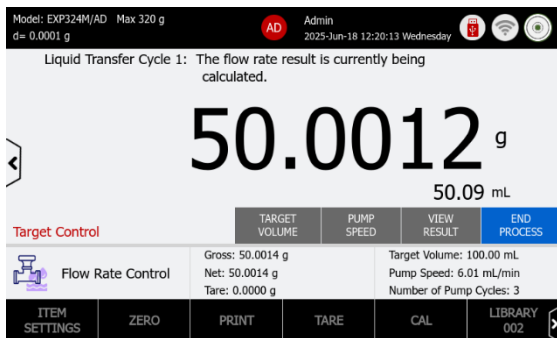

Step 2: Initiate the second pump output

- Press START button to pump the liquid to the test tube when the volume is close to the target volume, the screen will capture the result.
- Continue this process until all the pump cycle has been captured and calculated.

Step 3: View Result

After all the cycle is completed, the screen will automatically go to VIEW RESULT.

The result information is including:

- Pump Speed, Max Flow Rate, Min Flow Rate, Average Flow Rate and Number of Pump Cycles
- Example: The graphic below shows the result based on 3 times pump cycle testing, the average pump speed is 2784.67 mL/min
- The user can print the result using a printer or a PC and save the result in PDF format. The graphic chart cannot be saved on any storage device.

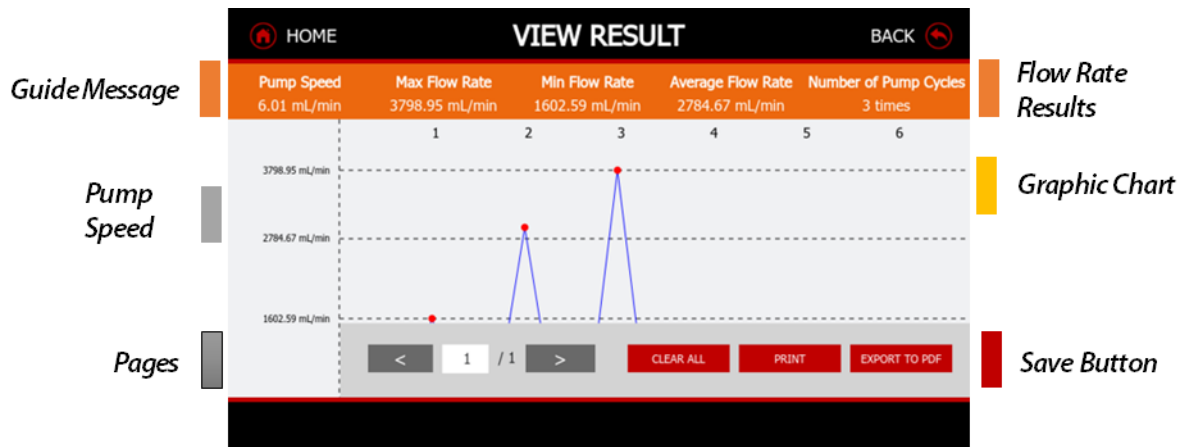

4.16.5 Sample Library – Flow Rate Control

Explorer Plus balance built in library simplifies working with multiple samples, allowing application settings to be saved and recalled for reuse.

The Sample Library can store up to 3000 records, without limitation on individual applications. To check the status of library usage, navigate to Main Menu > Library.

Note: In Main Menu > Library, the balance would notify users to delete or export libraries when the storage is used 80%.

Create, Activate and Delete a Library

- Press “+New Library” button to create a new Pump Library.
- When a new library is created, it remains inactive. The operator has to activate the library after ticking the box.
- Press on the RUBISH BIN button to delete a library.
- After the library item is activated, the main screen will show the activated library number.
- Library Example: In Library 003, the Pump Speed is 6.01 mL/min, Pump Speed is 1 minute, and 3 times of Pump Cycles will be calculated.

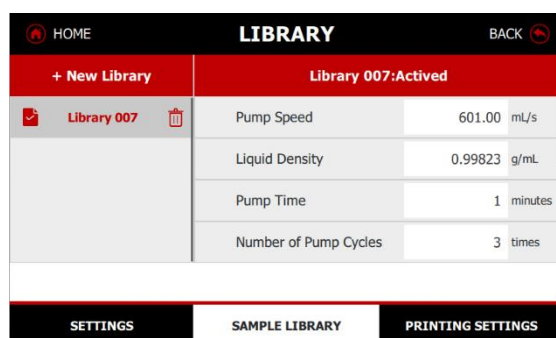

4.16.6 Print Settings

The Explorer Plus balance offers advanced print settings. Users can customize the output format and content and direct it to Excel or save it in a USB-compatible format. Additionally, users can review the print content to ensure all items are correctly selected before printing on paper or PC.

For details of Print Settings, please refer to section 6.0.

5.3 Quick Setup

The Quick Setup menu is designed for first-time users. By quickly navigating through this menu, you can easily configure the most desired functions.

5.3.1 Language

Set the language for menu display and pop-up messages. The default setting is configured based on the country of sale. The 13 available languages are English, German, French, Spanish, Italian, Polish, Czech, Hungarian, Portuguese, Chinese, Japanese, Korean, and Turkish.

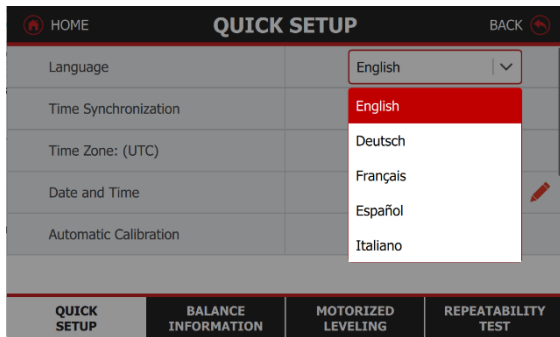

5.3.2 Time Synchronization/ Network Server

The new balance features Synchronization with Network (NTP function) which can use consistent time and data from the local network. The NTP system supports DNS domain name resolution.

- When you input the address of a public domain server, it will automatically convert it into an IP address. Here are some examples of NTP public time server address
 - “0.europe.pool.ntp.org” when the location is in Europe
 - “cn.ntp.org.cn” for China
 - “0.us.pool.ntp.org” for the US

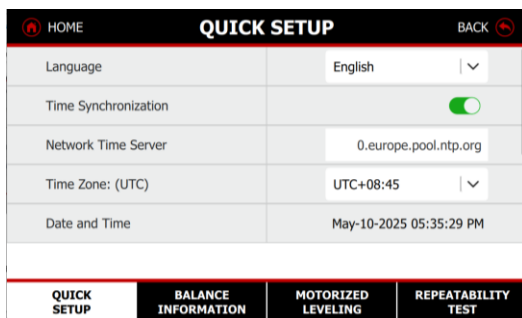

5.3.3 Date and Time

If you are using the balance offline, the new date/time setting fulfill your documentation needs with UTC time zone and customized the time format MMM-DD-YY HH-MM-SS and working weekdays setting.

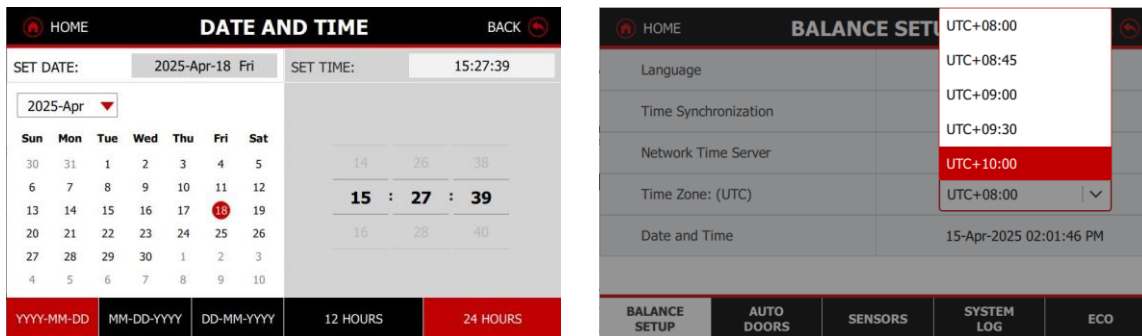

5.3.4 Automatic Calibration

When Automatic Calibration is set ON, the balance performs a self-calibration: AutoCal will automatically calibrate the Balance (using the internal mass) each time there is a change in temperature significant enough to affect accuracy or every 11 hours.

An information screen will appear when an Automatic Calibration is about to start. Three option buttons will be displayed:

- Now – Press to perform the calibration directly.
- After 5 min – Press to perform the calibration after 5 minutes.
- Deactivate – Press to deactivate the Automatic Calibration function

5.3.5 User Management

When **User Management** is set ON, the balance will be able to create up to 200 user accounts, featuring four predefined roles. 4-level user management with an underdefined user group with access rights to the balance.

- Administrator (1)
- Supervisor (maximum of 20)
- 179 allocated to other roles like operator, log viewer, and group users

Refer to Section 5.10 for detailed information on User Management.

5.3.6 System Log

When the **System Log** is enabled, the balance can store up to 100,000 log entries. It consists of System Log, Calibration Log, Printed Data Log, and Failure log. These electronic records include changes made on balance setting will keep records in system log file. e.g. every printed data, date/time change, balance setting changes, perform calibration action, user log in/log out, user account create/edit/delete and etc.

Refer to Section 5.8 for detailed information on System Log.

5.3.7 Balance Information

The balance information will display the Information displayed includes:

- Balance Information: Balance ID, Balance Model, Balance Software Version, Digital Loadcell Type, and Digital Loadcell Software Version
 - The balance max capacity, readability, d and (e) value are displayed in the Upper left corner of the main screen.
- Environmental Parameters: Loadcell Temperature, Humidity, and Atmospheric Pressure
 - The loadcell temperature, humidity, and air pressure are displayed in the reference field.
 - The user can click on the display to turn it off.

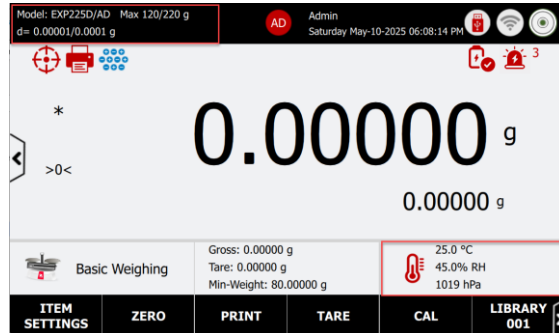

5.3.8 Motorized Leveling

The Motorized Leveling System is a simple and effective balance feature for the first user setup and the servicing dealers. Press Start button to level the balance automatically. The initial digital level bubble will indicate the bubble status in real time.

Before starting the motorized leveling process, kindly remove the weight from the weighing pan.

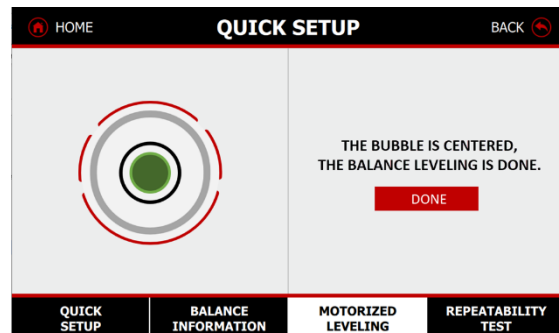

- After the balance is leveled, the digital bubble will display green at the upper right corner in the main screen
- If the leveling system fails to level the balance successfully, move the balance to a relatively flat surface. The warning notification will appear.

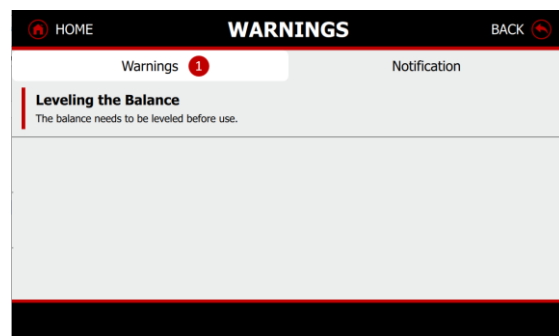
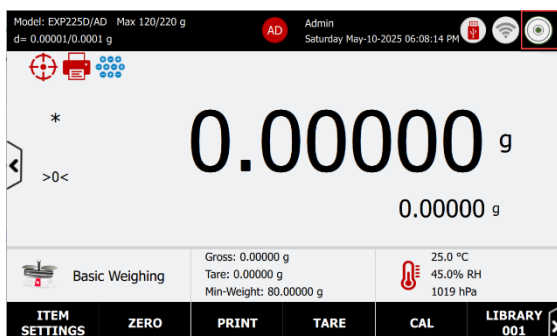

5.3.9 Repeatability Test

This function is designed to conduct the daily repeatability test of the balance. Users can perform a 10-time repeatability test using weights that are close to their daily working point.

Note: To determine the minimum weight in accordance with <USP41>, test environment must be equivalent to standard lab <USP1205> and the test weights must be certified and their values checked periodically.

- Press Repeatability Test tab and then follow the onscreen instruction.

Step 1: Set Number of Repeatability Tests, Test Weight ID, Test Weight Value and Test Weight Class in this menu.

The Number of Tests, Test Weight ID, Test Weight Value, and Test Weight Class can be set in accordance with the workshop's standard procedure.

- The default setting is 10 times in Number of Test

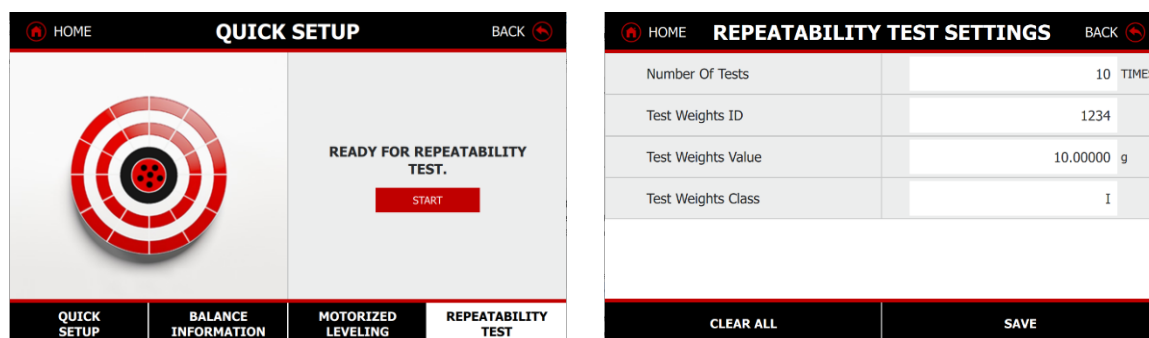

- Press Save button to store all the settings.

Step 2: Perform repeatability Test

- Place the balance in a stable environment and press Zero or Tare before starting.
- Press the Start button to place weights on the pan one by one.
- During the testing, do not tare or zero the pan, as the load will calculate all factors to produce accurate results.
- Example: After 10 tests with 10-gram weights, the balance will automatically display the repeatability test results.

Step 3: Review report

- Press the View History button to review the last repeatability test result.
- Press the Print button to print the repeatability test report and or export it to a PDF file when a USB flash drive is inserted.
- Press Min-weight to display the reference minimum weight.

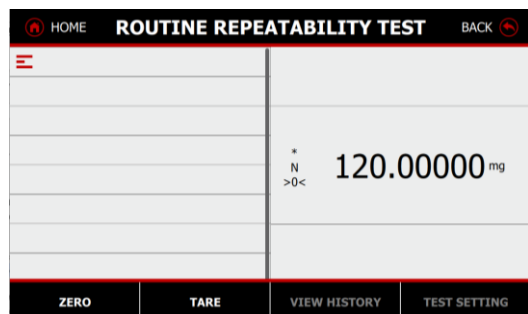

5.4 Calibration

Explorer Plus Balances have an Automatic Calibration System. The Explorer PLUS offers a choice of three calibration methods: Calibration Method: Automatic Calibration, Internal Calibration (User triggered), Span Calibration, and 3000 x Calibration History/ Log.

- Calibration is accomplished with the internal calibration mass. Internal calibration can be performed at any time, provided the balance has warmed up to operating temperature and is level.
- In the main screen, the user can press CAL button to perform Internal Calibration.

Note: Do not disturb the balance during any calibration.

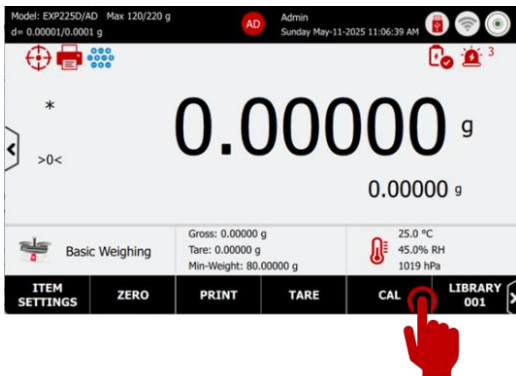

5.4.1 Calibration Settings

The Calibration Setting is used to configure the calibration method and the calibration points for Span Calibration.

- Internal Calibration
 - On/Off Internal Calibration function
 - Default setting: ON
- Automatic Calibration
 - When Internal Calibration is set ON, the balance performs a self calibration:
 - The environment temperature change of 1.5°C
 - Every 3 hours for Semi-Micro model, Every 11 hours for other models
 - Default setting: ON
- AutoCal Interval Hours: The automatic calibration is triggered by a time-based schedule.
 - Enable the Automatic Calibration function, user can defined the time.
 - The value can be set from 3-11 hours.
- Print Automatic Calibration
 - Enable the auto-print function. When the AutoCal is completed, the balance will send the calibration report to the PC or printer if connected.

- Span Calibration Points
 - The Span calibration uses two calibration points, one at zero load and the other at specified full load (span). For detailed calibration mass information please see the specification tables in section 9.
 - Refer to model specification table 11.2 for factory default span calibration points.
 - The user can defined the Span Calibration weights value by preset value and alternative weights.
 - ◆ Alternative Span Calibration Points: The weight value between 20% and 100% of the maximum balance capacity.

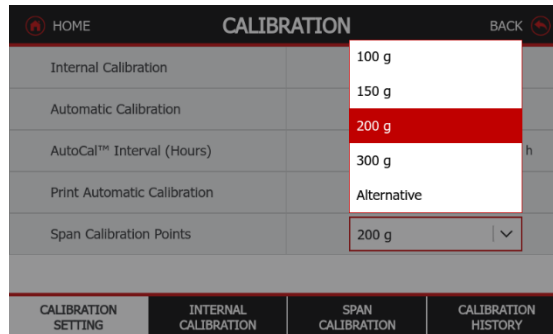
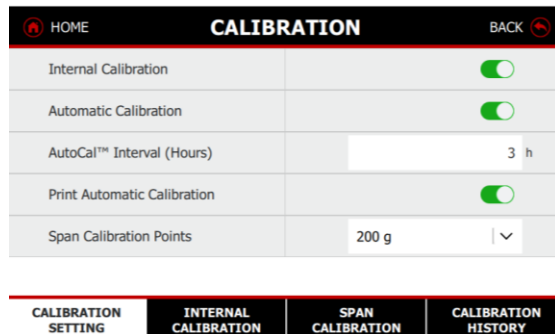

Note: Time out is 40 seconds

5.4.2 Internal Calibration

Internal calibration is performed using the built-in calibration weight. This process can be initiated at any time, as long as the balance has reached its operating temperature and balance is properly leveled.

Step 1: Start Calibration Process

- Press **Internal Calibration tab**, and press **Start**. The Balance will begin to calibrate. To cancel at any time, press **Cancel**.

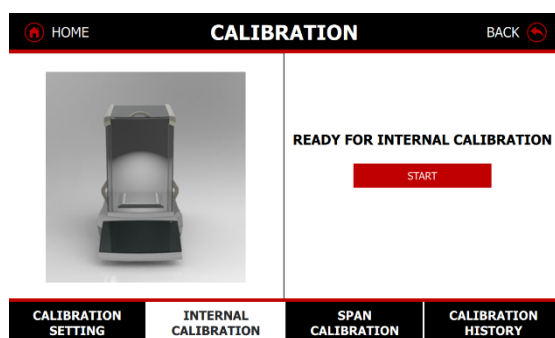

Step 2: Verify the calibration result

- After calibration, place the test mass on the pan and verify that the mass value now matches the displayed value. If not, repeat the procedure until the reading agrees with the test mass.

Step 3: Calibration Report

- When the calibration process is completed, the balance will generate a calibration report that includes the following information:
 - Date/Time: Week, Date and Time
 - Balance ID: Balance series number
 - Balance Name: Balance Model
 - Result: Successful or Failed
 - Signature: User ID (when the user management is set on)

- Verified by: User can input the User ID/ Password or use the Fingerprint accessory to input the User information automatically. The fingerprint accessory order number is in the accessory list in Section 11.5.
- Press the Print button to print the calibration report, and the results will be saved in the Calibration History for future reference.

5.4.3 Span Calibration

Step 1: Select Span Calibration weights value in the Calibration Setting

- Different capacity balances have different Span Calibration points. Users can choose the best Span Calibration points by using either the full load or half load of the balance's capacity.
- If the weights are certified with a tolerance value, users can input an **Alternative Weight Value** before starting the Span Calibration process.

Calibration Masses Table

Model	Span Calibration Points	Weight Class	
EXP125D/AD; EXP125DM/AD	25g, 50g, 75g, 100g	ASTM Class 1	OIML E2
EXP125/AD; EXP125M/AD	25g, 50g, 75g, 100g	ASTM Class 1	OIML E2
EXP225D/AD; EXP225DM/AD	50g, 100g, 150g, 200g	ASTM Class 1	OIML E2
EXP225/AD; EXP225M/AD	50g, 100g, 150g, 200g	ASTM Class 1	OIML E2
EXP124/AD	25g, 50g, 75g, 100g	ASTM Class 1	OIML E2
EXP224/AD	50g, 100g, 150g, 200g	ASTM Class 1	OIML E2
EXP324/AD, M, N	100g, 150g, 200g, 300g	ASTM Class 1	OIML E2
EXP223/AD	50g, 100g, 150g, 200g	ASTM Class 1	OIML E2
EXP423/AD	100g, 200g, 300g, 400g	ASTM Class 1	OIML E2
EXP623/AD	300g, 400g, 500g, 600g	ASTM Class 1	OIML E2
EXP1203/AD, M, N	400g, 600g, 800g, 1000g	ASTM Class 1	OIML E2
EXP2202	500g, 1000g, 1500g, 2000g	ASTM Class 1	OIML E2
EXP4202	1000g, 2000g, 3000g, 4000g	ASTM Class 1	OIML E2
EXP6202	2000g, 3000g, 4000g, 6000g	ASTM Class 1	OIML E2
EXP8202	2000g, 4000g, 6000g, 8000g	ASTM Class 1	OIML E2
EXP10202, M, N	6000g, 8000g, 10,000g, 12,000g	ASTM Class 1	OIML E2
EXP6201	2000g, 3000g, 4000g, 6000g	ASTM Class 2	OIML F1
EXP8201	2000g, 4000g, 6000g, 8000g	ASTM Class 2	OIML F1
EXP10201	2500g, 5000g, 7500g, 10,000g	ASTM Class 2	OIML F1
EXP24001	10000g, 15000g, 20000g, 24000g	ASTM Class 2	OIML F1
EXP35001	10000g, 20000g, 30000g, 35000g	ASTM Class 2	OIML F1
EXP65001	20000g, 40000g, 60000g, 65000g	ASTM Class 2	OIML F1

Step 1: Start Calibration Process

- Press **Span Calibration tab**, and press **Start**, the Balance will begin to calibrate. To cancel at any time, press **Cancel**.
- Follow the guide message to place the weights on the pan and wait until the balance is stable.

Step 2: Verify the calibration result

After calibration, place the test mass on the pan and verify that the mass value now matches the displayed value. If not, repeat the procedure until the reading agrees with the test mass.

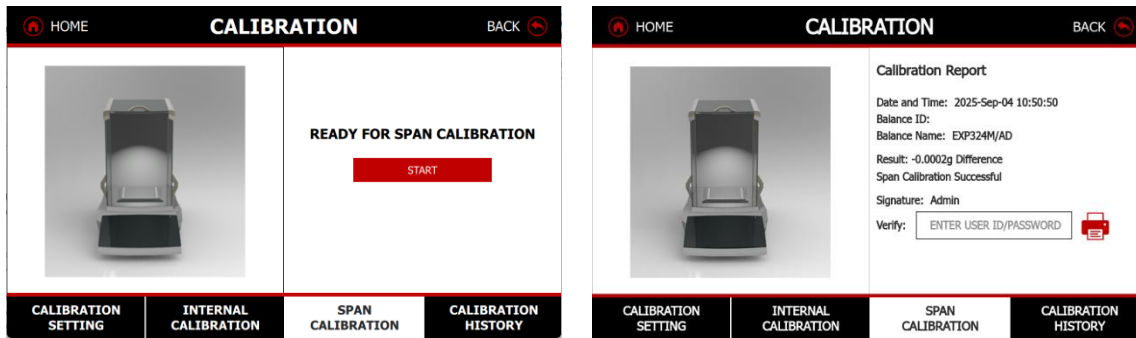

Step 3: Calibration Report

- When the calibration process is completed, the balance will generate a calibration report that includes the following information:
 - Date/Time: Week, Date and Time
 - Balance ID: Balance series number
 - Balance Name: Balance Model
 - Result: Successful or Failed
 - Signature: User ID (when the user management is set on)
 - Verified by: User can input the User ID/ Password or use the Fingerprint accessory to input the User information automatically. The fingerprint accessory order number is in the accessory list in Section 11.5.
- Press the Print button to print the calibration report, and the results will be saved in the Calibration History for future reference.

5.4.4 Calibration History

The balance can store up to 3000 x Calibration History/ Log whenever the calibration is performed.

The total memory is displayed as xx/xx% in the upper right corner. At any time, users can export the calibration records to a PDF file when a USB flash drive is inserted.

Note: When the user activates the **System Log** function, the calibration history will be recorded as **Calibration Log** in the Service Menu.

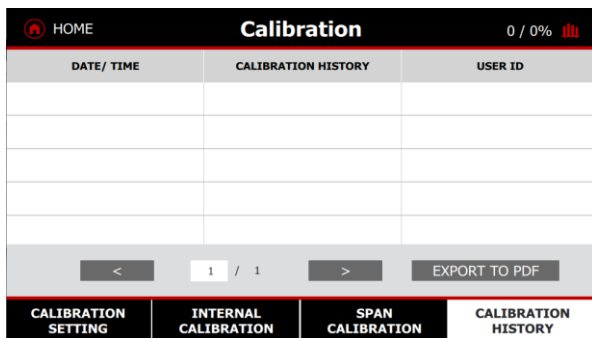

5.5 Balance Setup

Enter this sub-menu to customize Balance functionality

5.5.1 Language

Set the language for menu display and pop-up messages. The default setting is configured based on the country of sale. The 13 available languages are English, German, French, Spanish, Italian, Polish, Czech, Hungarian, Portuguese, Chinese, Japanese, Korean, and Turkish.

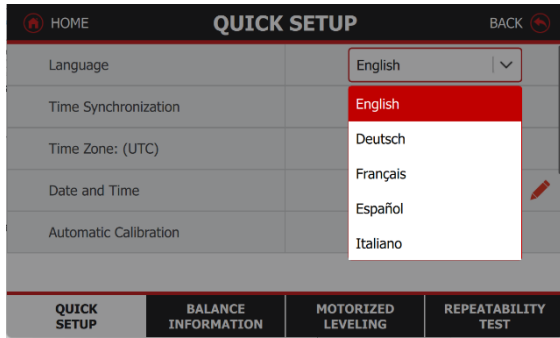

5.5.2 Time Synchronization/ Network Server

The new balance features Synchronization with Network (NTP function) which can use consistent time and data from the local network. The NTP system supports DNS domain name resolution.

- When you input the address of a public domain server, it will automatically convert it into an IP address. Here are some examples of NTP public time server address
 - “0.europe.pool.ntp.org” when the location is in Europe
 - “cn.ntp.org.cn” for China
 - “0.us.pool.ntp.org” for the US

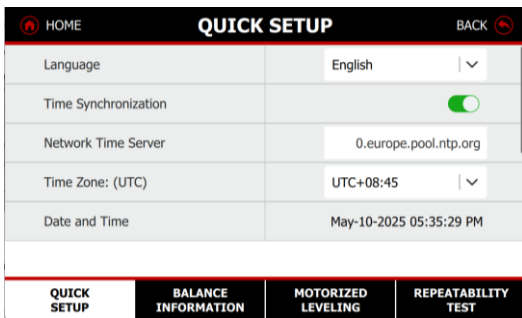

5.5.3 Date and Time

If you are using the balance offline, the new date/time setting fulfill your documentation needs with UTC time zone and customized the time format MMM-DD-YY HH-MM-SS and working weekdays setting.

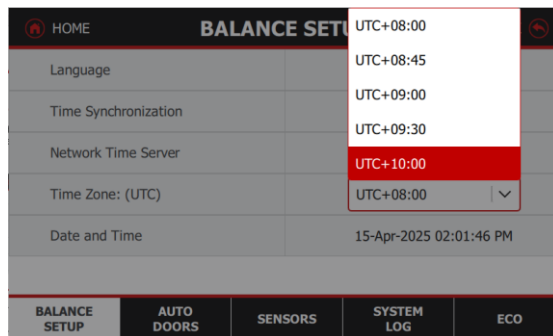

5.5.4 Balance Name

Set the balance identification. Alphanumeric settings up to 25 characters are available. The default setting is the model name of the balance

5.5.5 Change Password

- Change the password for the currently logged-in user. The Password Policy is defined in User Management:
- Option 1: Alphanumeric password containing 8 to 10 characters, combining letters and numbers.
- Option 2: Numeric password containing up to 25 characters.

Refer to Section 5.10 for detailed information on User Management.

Note: If you forget your password, please contact Ohaus or your local Ohaus dealer for assistance.

5.5.6 Fingerprint Log In / Fingerprint Setting

The fingerprint data is stored within the module itself. The OHAUS Balance cannot decrypt the original biometric data. A legal statement will be displayed on the terminal. The fingerprint data cannot be extracted from the module. This is because the module supplier defines the identification protocol for the fingerprint data. The OHAUS balance only manages the fingerprint ID derived from the original fingerprint data. The balance cannot transfer or copy the fingerprint ID from other balances.

2 Fingerprints per user, and total 100 x Fingerprint Identifications are available for user management control. Refer to the accessory list in Section 11.1.

Step 1: Connect terminal with the fingerprint accessory

Connect the cable to the terminal RJ11 port, and the fingerprint accessory will be ready for use.



Step 2: Enroll the first fingerprint

- Place your finger on the sensor and follow the prompts to add your fingerprint.
- Repeat this process five times. After five successful readings, the balance will enroll your fingerprint data.
- As a final step, place your finger on the sensor again to verify that the stored data matches your fingerprint.

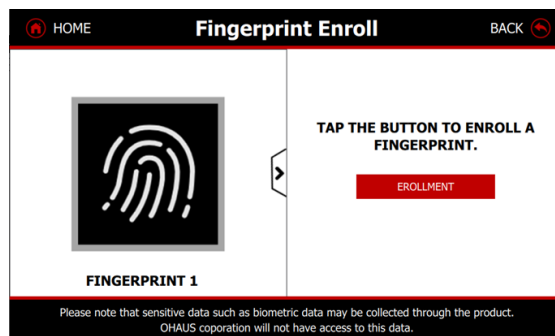
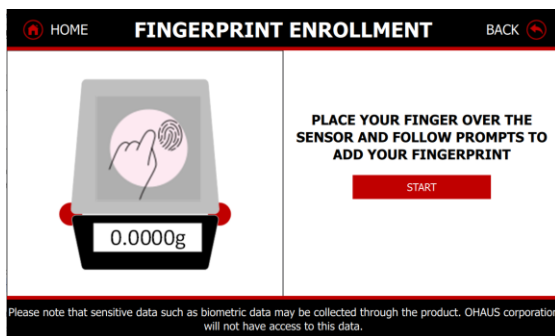

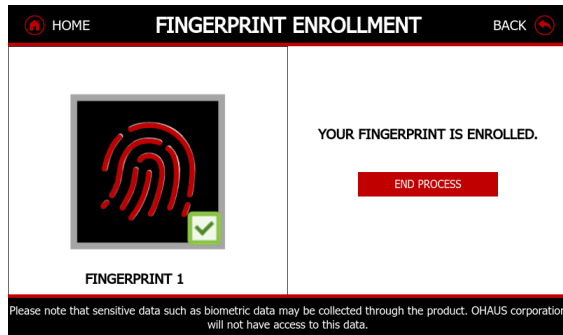
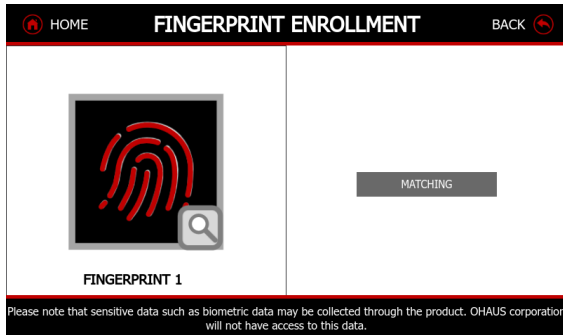
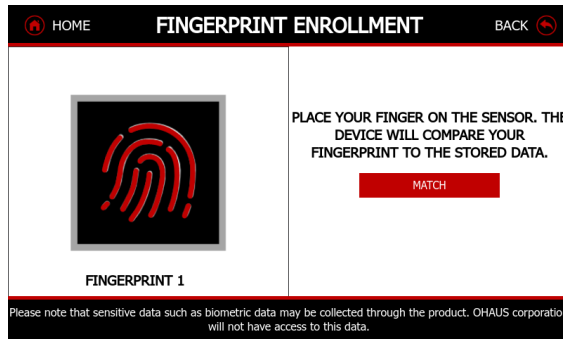
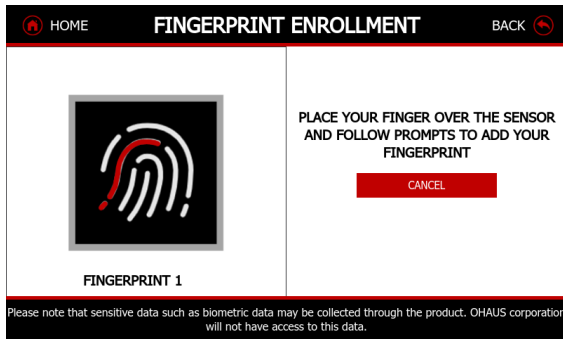

Step 2: Enroll the second fingerprint

- Tap the right arrow button to add new Fingerprint.
- The screen will show FINGERPRINT 2.

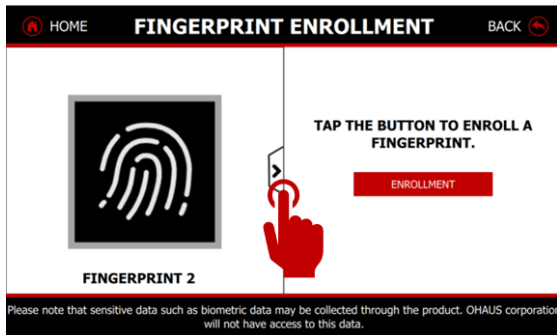

- Place your finger on the sensor and follow the prompts to add your fingerprint.
- Repeat this process five times. After five successful readings, the balance will enroll your fingerprint data.
- As a final step, place your finger on the sensor again to verify that the stored data matches your fingerprint.

Deactivate the Fingerprint Function

In user management, Administrator will turn on/off on user's fingerprint. Refer to Section 5.10 for detailed information on User Management.

Delete Fingerprint

- To delete a fingerprint record, press the trash bin button. If you need to delete another fingerprint, press the right arrow button.
- To delete all fingerprint records, go to the Factory Reset menu and perform a reset.

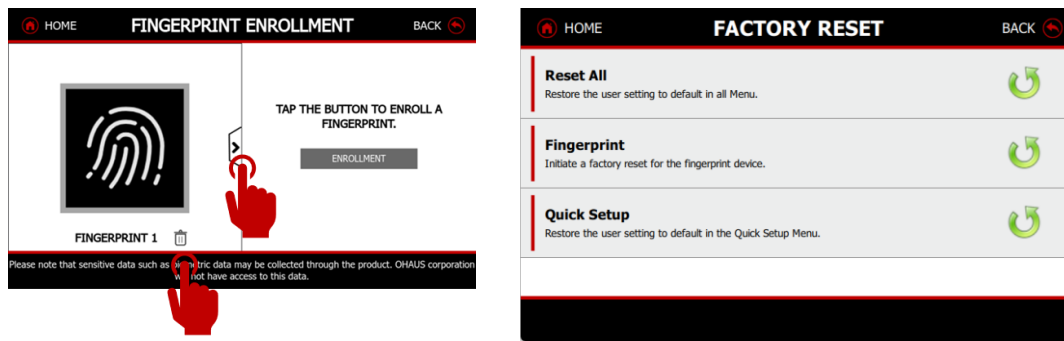

Legal Information

Legal Information will stay at the setting screen to comply with biometric authority regulation

Notes: The sensitive data such as biometric data may be collected through the product. OHAUS corporation will not have access to this data.

5.5.7 Filter Level

Set the amount of signal filtering: 1, 2, 3, 4, **5** (default), 6, 7, 8, 9. The higher the number means slower the stabilization time with more stability.

5.5.8 Stability Indicator Range

Set the amount the reading can vary while the stability symbol remains on.

- 0.25 = 0.25 stability factor
- 0.5 = 0.5 stability factor
- **1 = 1 stability factor (default)**
- 2 = 2 stability factor
- 3 = 3 stability factor
- 4 = 4 stability factor

5.5.9 Auto Zero Tracking

Set the automatic zero tracking functionality.

- Off = disabled.
- 0.5 d = display maintains zero up to a drift of 0.5 graduation per second
- 1 d = display maintains zero up to a drift of 1 graduation per second.
- 3 d = display maintains zero up to a drift of 3 graduations per second.

Note: When Legal for Trade is set to ON, the AZT setting is forced to 0.5 D.

The OFF setting is still available. The setting is locked at the current setting when the Legal for Trade switch is set to the ON position.

5.5.10 Gross Indicator

Set the symbol displayed for gross weights.

- Off = Disabled
- GROSS = the G symbol is displayed.
- BRUTTO = the B symbol is displayed.

The setting is locked at the current setting when the Legal for Trade switch is set to the ON position.

5.5.11 Graduation

Set the displayed readability of the balance.

- 1 d = standard readability.
- 10 d = readability is increased by a factor of 10.

For example, if the standard readability is 0.01g, selecting 10 Divisions will result in a displayed reading of 0.1g.

The setting is locked at the current setting when the Legal for Trade switch is set to the ON position.

5.5.12 Ionizer

Electrostatic charges on weighing containers and samples can result in false readings or instability as they create attractive and repulsive forces. The Explorer Plus Balance has built-in ionizers (Electrode brush) to neutralize the weighing chamber.

Set the ionizer's working time to either 5 or 10 seconds. Typically, 5 seconds is sufficient to eliminate static electricity from a sample. However, in cases where the air is extremely dry or the sample volume is large, a longer working time of 10 seconds may be necessary.

Note: For optimal results, it is recommended to place the lab spoon at the center of the ionizer electrodes before weighing.



5.5.13 Approved Mode

Use this menu to set the Legal for Trade mode.

- OFF = standard operation.
- ON = operation complies with Weights and Measures regulations.

Note:



- The security switch must be in the locked position to set Legal for Trade to ON.
- When Legal for Trade is set to ON, the menu settings are affected as follows:

■ Calibration Menu:

- ◆ Automatic Calibration is set to ON and the menu is hidden. Internal Calibration is available, while all other functions are concealed.
- ◆ For EXP...N... models: Automatic Calibration will be locked at its current setting.

If you set Internal Calibration to be ON before you turn on Approved Mode, Internal Calibration menu will still be available. If you set Internal Calibration to be OFF before you turn on Approved Mode, Internal Calibration menu will be locked.

- **Balance Setup Menu:**
 - ◆ Auto Tare and Gross Indicator are locked.
 - ◆ Graduations are forced to 1 Division and the menu item is hidden.
 - ◆ For EX...N...models, graduations will be locked at its current setting.
 - Weighing Units menu: all units are locked at their current settings.
- **Communication Menu:**
 - ◆ Stable Weight Only is locked ON.
 - ◆ For EX...N...models, auto print mode selections are limited to OFF, On Stability, and Interval. Continuous is not available. Numeric Value Only is locked OFF.
- **Legal for Trade Switch:**

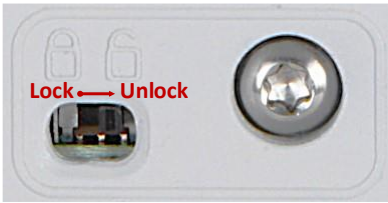
	Explorer Plus Analytical and Precision Balance	Explorer Plus High-Capacity Balance
Position		
Unlock / Lock		

5.6 Auto Door

The balances feature an anti-pinch, half open, and full open auto door function for safe and easy sample access.

- - If the user accidentally, the door will stop to prevent hitting the object.
- - If the user accidentally places their hands or other objects at the back of the doors while they are automatically opening, the door will retract to prevent hitting the object.

- To achieve a faster stabilization time when weighing powder samples, the door can be set to either half-open or fully open.

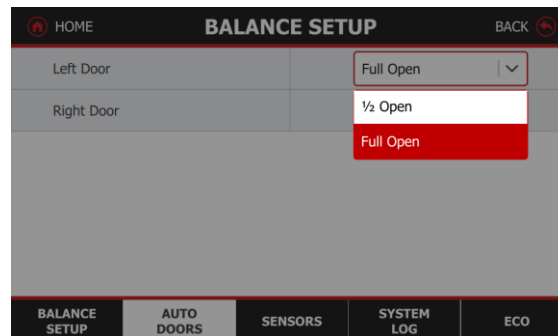

5.7 Sensor

There are 2 touchless sensors on the top of balance terminal.

When the user waves their hand over the sensor, the function will be activated, and a green light will flash for a second. The available settings are as follows: Print, Zero, Tare, Calibrate, Ionizer, Automatic Draft Shield Door, or Draft Shield Light. If the sensor is not activated, the sensor light will be red.

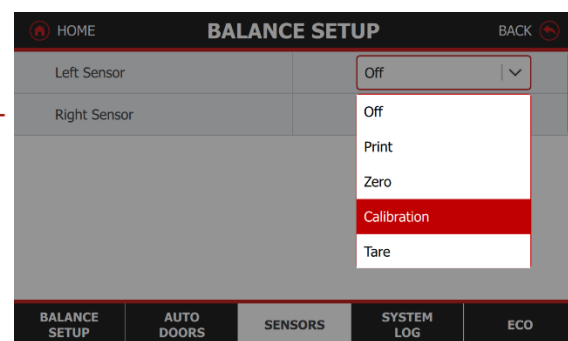

5.8 System Log

- All the changes made to the balance settings will keep records in system log file. e.g. every printed data, date/time change, balance setting changes, calibration actions, user log in/log out, user account create/edit/delete etc. These system log files can be reviewed and exported as a PDF to a USB flash drive.
- Internal system log capacity of 100,000 records can be stored in balance memories. When the memory is full, a message will appear for exporting the log files to a USB flash drive.
- System Log is saved in the Service Menu. See the detail function in section of Maintenance / System Log.

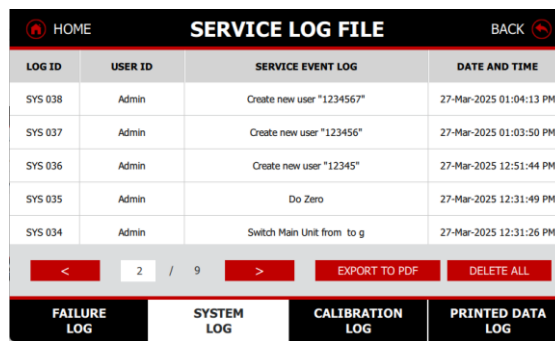
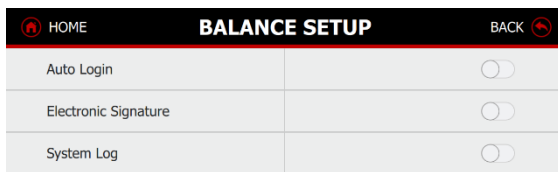

Auto Login

- Auto login is beneficial for Admin users who have not set a password, as no login is required after pressing the standby button.
- Other users cannot use this function when user management is enabled.

Electronic Signature

When the Electronic Signature feature is enabled, the User ID will be used in the printout field when the User ID content option is selected. For details, refer to the printout template in the Printing section.

System Log

Users can enable or disable the System Log as needed. When it is deactivated, changes to the balance will not be recorded in the balance memory.

5.9 ECO

OHAUS places energy-saving design as one of its top priorities, evident in all of its laboratory weighing products which feature power-saving capabilities. As a leading laboratory equipment manufacturer, this small step forward demonstrates our commitment to these important causes.

OHAUS electronic balances are designed with a three-tiered energy-saving strategy.

- **Off** means the touchscreen display will operate with default settings.
- **Auto Dim** means the display will shift to a darker shade when there is inactivity.
- **Auto Standby** indicates the machine will log itself off automatically.
- **Sleep Mode** indicates that the display will be turned off at a predetermined time, while only retaining the base operation power.

5.9.1 Power Saving

- When the user selects Auto Dim and Auto Standby, the ECO time will automatically be set to 20 minutes. Additionally, the brightness, volume, and light functions will be locked to conserve power.
- When the user selects Sleep mode, the ECO time will automatically be set to 0 minutes. Additionally, the brightness, volume, and light functions will be locked to conserve power.

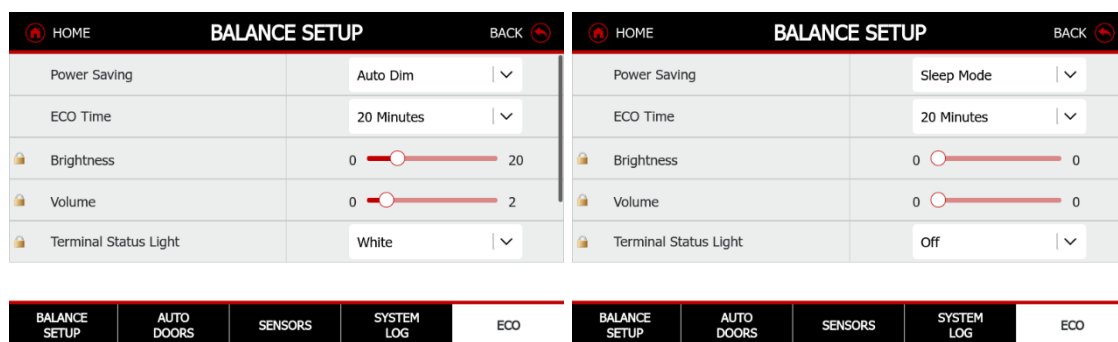

5.9.2 Brightness

Screen Brightness: Adjust the brightness from 0 to 100. Default value= 90

5.9.3 Volume

Adjust the volume from 0 to 20. Default value= 2

The Explorer Plus balance offers three sound options: a sound for click sound, successful actions, and an error sound.

5.9.4 Status lights

The lighting system can be customized into rainbow colors.

Terminal Status Lights: Users can change the light to different colors, such as Red, Pink, Yellow, Green, Cyan, Blue, and White.

Rainbow Draft Shield Lights: Users can change the light to different colors, such as Red, Pink, Yellow, Green, Cyan, Blue, and White.

- **Note:** Overload, Accept, Underload color applies to application mode: check weighing and check counting



Sample spotlight for enhanced visibility and make a “ClearView” environment. Users can turn on and off this light. Spotlight color: White.

5.10 User Management

The enhanced user management system enables administrators to create up to 200 user accounts, featuring four predefined roles. 4-level user management with an underdefined user group with access rights to the balance.

- Administrator (1)
- Supervisor (maximum of 20)
- 179 allocated to other roles like operator, log viewer, and group users

User Management: The User Name is generated from First Name and Last Name entries.

Note: The User ID is unique and cannot be changed once it is confirmed. This is especially important once you enable Electronic Signature.

The Group User function is designed to allow multiple users to share the same access permissions for balance settings.

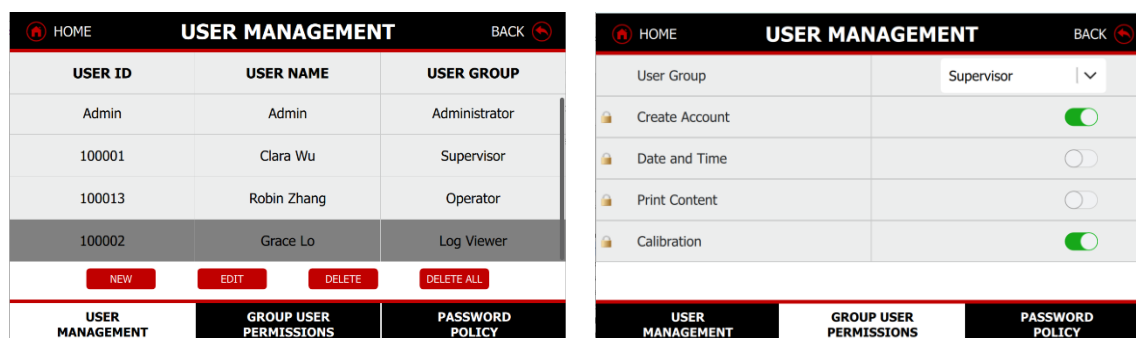

5.10.1 Create, Edit Delete a User

Admin can create, edit or delete Supervisor, Operator and Log Viewer, while Supervisor can create, edit or delete Operator. Operator and Log Viewer cannot access User management menu.

To create new users or edit or delete the current users

- Press to New button to add new user account, press Edit button to modify the user profiles
- Press delete or delete all user accounts by Administrator or Supervisor.

Note: Admin user cannot be deleted.

5.10.2 Preset User Role Accessibility

Settings	Administrator	Supervisor	Operator	Log Viewer (Auditor)	Group 1 User	
Number of Users	1 person	20 people	Total 179 people			
Create Account/Delete Account	Create/Edit/Delete: Supervisor, Operator, Log viewer or Group user	Create/Edit Operator	x	x	√/ x	
Date and Time	√	x	x	x	x	
Print Content		√	x	x	√/ x	
Calibration Function		√	x	x	√/ x	
Weighing Units		√	√	x	√/ x	
Library		√	New, Load, Edit/Delete (own)	x	√/ x	
Factory Reset		√	√	x	x	√/ x
Routine Test		√	√	Allow to operate, not allow to change the Weights setting	x	√/ x
Balance Name		x	x	x	x	√/ x
Setup a Min-Weight		√	√	x	x	√/ x
Service Mode		x	x	x	x	√/ x
System Log	Read/Export/Delete	Read/Export	x	Read/Export	√ (Read/Export/Delete) / x	
Graduation	√	√	x	x	√/ x	

1d/10d					
--------	--	--	--	--	--

5.10.3 Group User Permissions

The Group User Permission function allows for the streamlined assignment of identical access permissions to multiple users. Four predefined groups are available: Administrator, Supervisor, Operator, and Log Viewer. In addition, a customizable Group 1 can be configured with unique access permissions.

All access options, except for Date and Time, Print Content, and Balance Name, are pre-configured and ready for use.

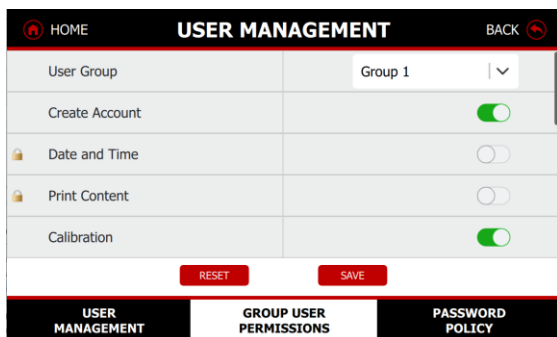

5.10.4 Password Policy

The system not only features alphanumeric password protection, but also incorporates an optional fingerprint login system.

The fingerprint login system offers a convenient and secure way to log in, eliminating the risk of forgetting passwords or unauthorized password leaks.

These measures safeguard the weighing data and the defined weighing process configurations, preventing them from being altered or deleted.

Expiration Days:

To set when password will expire. There are three selections, 30 days, 60 days and 90 days.

Password Requirement:

- Option 1: Alphanumeric password containing 8 to 10 characters, combining letters and numbers.
- Option 2: Numeric password containing up to 25 characters.

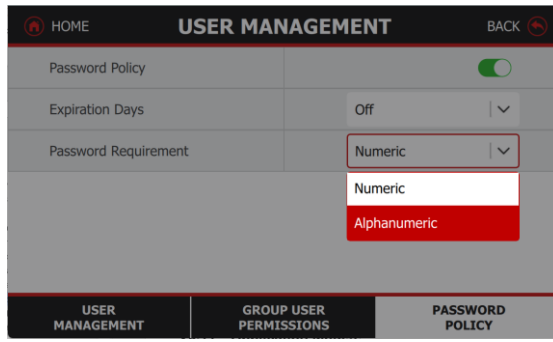
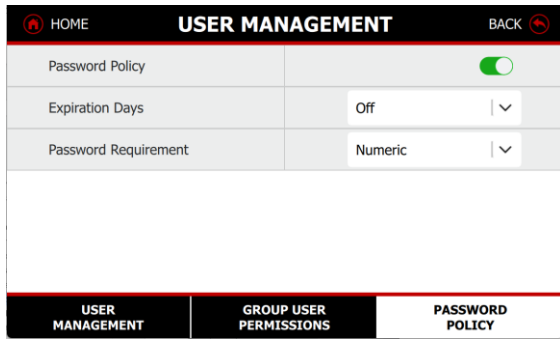

Note: If you forget your password, please contact Ohaus or your local Ohaus dealer for assistance.

5.11 Application Modes

The balance can be configured to operate in various Application modes.

Note: If an application mode does not appear in the list of available Applications, it must be enabled in the **Application Menu** touch Menu, then select Application Modes. The full list of modes appears. Touch the one you want to enable.

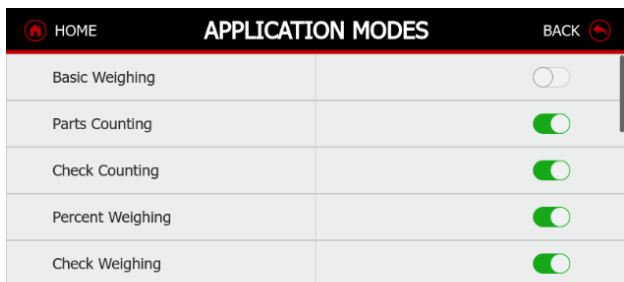
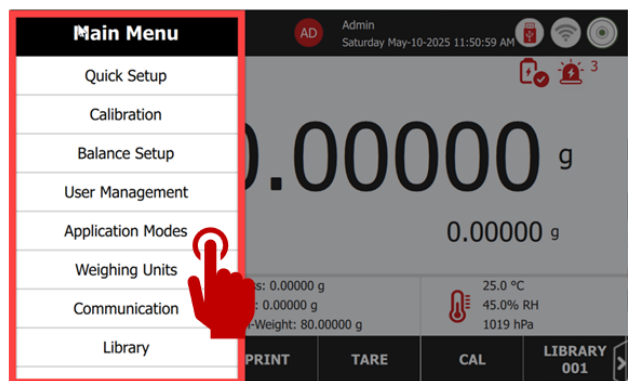
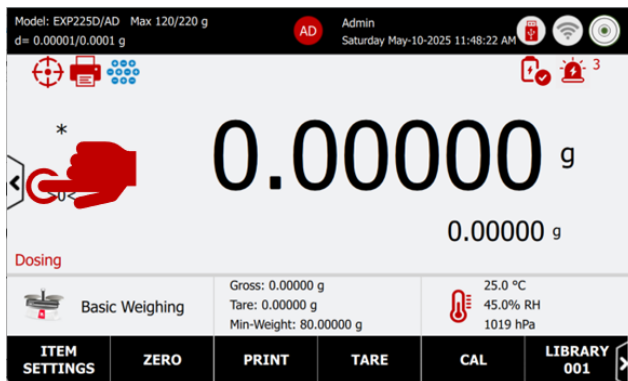

5.12 Weighing Units

The Explorer Plus balance can be configured to measure in a variety of weighing units, including 2 custom units. In the main screen, user can click “g” to switch an alternative weighing unit. The default unit is gram. In this menu, you can turn on/off the weighing unit according to the sample application.

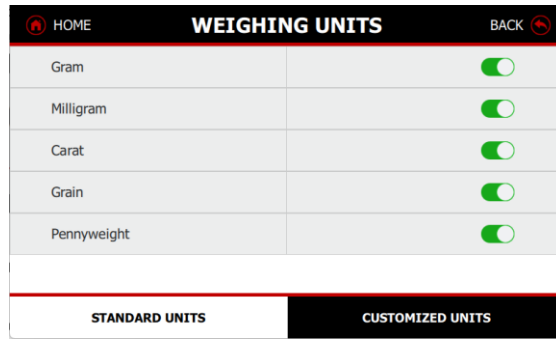
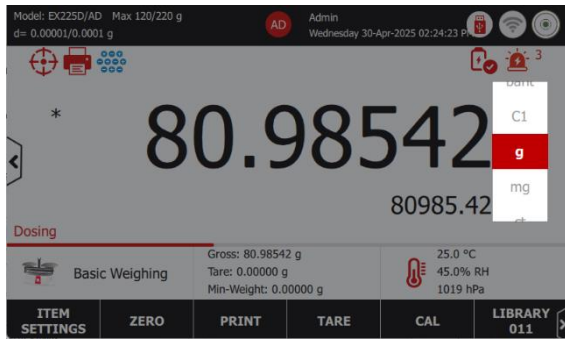

Customized Units

Use each Customized Unit to display weight in an alternative unit of measure. The custom unit is defined using a conversion factor, where the conversion factor is the number of custom units per kilogram expressed in scientific notation (Factor x 10^{Exponent}). For example: To display weight in troy ounces (32.15075 troy ounces per kilogram) enter a Factor of 0.321508 and an Exponent of 2. Set the status.

- OFF = disabled
- ON = enabled

When Customized Unit is set to ON, the Unit Name Factor, Exponent and Least Significant Digit must be set.

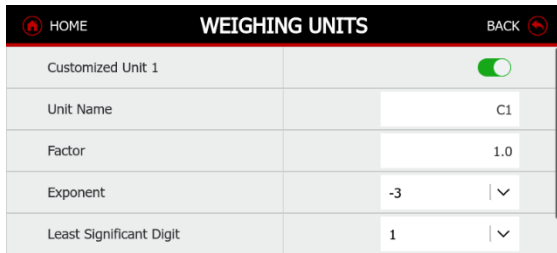

Factor: Set the conversion factor using the numeric keypad.

Settings of 0.00001 to 1.9999999 are available. The default setting is 1.000000

Exponent: Set the factor multiplier.

- 0 = multiply the Factor by 1 (1x10⁰)
- 1 = multiply the Factor by 10 (1x10¹)
- 2= multiply the Factor by 100 (1x10²)
- 3= multiply the Factor by 1000 (1x10³)
- -3 = divide the Factor by 1000 (1x10⁻³)
- -2 = divide the Factor by 100 (1x10⁻²)
- -1 = divide the Factor by 10 (1x10⁻¹)

Least Significant Digit: Set the graduation.

Settings of 0.00001, 0.00002, 0.00005, 0.0001, 0.0002, 0.0005, 0.001, 0.002, 0.005, 0.01, 0.02, 0.05, 0.1, 0.2, 0.5, 1, 2, 5, 10, 20, 50, 100, 200, 500 and 1000 are available.

Note: Least Significant Digit setting selections are dependent on the Factor and Exponent settings. Selections are limited.

5.13 Communication

The enhanced communication options include 2 USB Type-A ports, 1 USB Type-B port, 1 USB Type-C port, 1 Ethernet LAN, 1 RS232, 1 RJ11, and optional Bluetooth and Wi-Fi functionalities.

Additionally, the Explorer Plus balance supports HID (Human Interface Device) connection to a computer without requiring drivers. This enables users to use a mouse or keyboard to enter information such as User Name, USER ID, sample name, batch name, and other input details. The input field supports English and French characters, as well as numbers and symbols.

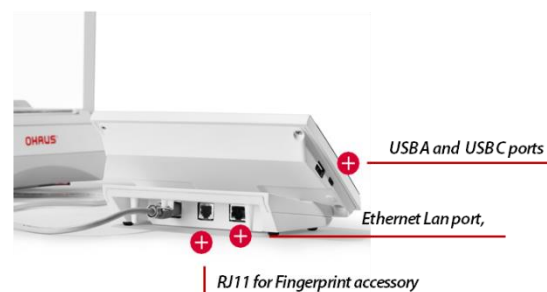

Enter this menu to define external communication methods and to set printing parameters. Data may be output to either a Printer, PC and or Fingerprint accessory.

-

USB Type A	USB Type A – Connect to USB flash driver, RFID Reader, Barcode Scanner and Wi-Fi & Bluetooth Dongle
USB Type B	Connect Balance to PC
USB Type C –	Connect Balance to PC
Ethernet Lan port	Connect Balance to PC
RS232	Connect Balance to Printer or PC
RJ11	Connect Balance to Fingerprint accessory

5.13.1 RS232

The RS232 port can connect to various peripheral devices such as printers, PCs, and label printers, each with different output formats. Ensure you select the appropriate peripheral device before transferring data.

- The connection settings for Printer and PC are as follows. Factory default settings are indicated in bold.
 - **Baud Rate** Set the baud rate (bits per second).
 - ◆ 1200 = 1200 bps
 - ◆ 2400 = 2400 bps
 - ◆ 4800 = 4800 bps
 - ◆ **9600 = 9600 bps**
 - ◆ 19200 = 19200 bps
 - ◆ 38400 = 38400 bps
 - ◆ 115200 = 115200 bps

- **Transmission Set the data bits, stop bit, and parity.**
 - ◆ 7 EVEN 1 = 7 data bits, even parity, 7 ODD 1 = 7 data bits, odd parity
 - ◆ 7 NONE 1 = 7 data bits, no parity
 - ◆ **8 NONE 1 = 8 data bits, no parity**
 - ◆ 7 EVEN 2 = 7 data bits, even parity, 7 ODD 2 = 7 data bits, odd parity, 7 NONE 2 = 7 data bits, no parity, 8 NONE 2 = 8 data bits, no parity
- **Handshake Set the flow control method.**
 - ◆ NONE = no handshaking
 - ◆ **XON-XOFF = XON/XOFF handshaking**
 - ◆ HARDWARE = hardware handshaking
- **12V Output**
 - ◆ Enable the function to allow the RS232 port to output 12V, which supports the Bluetooth Adaptor.
 - ◆ Example: When users connect an SF40A/BT printer to the balance, they need to enable this function.

Note: The purpose of this switch is to prevent damage to external devices from the 12V output.

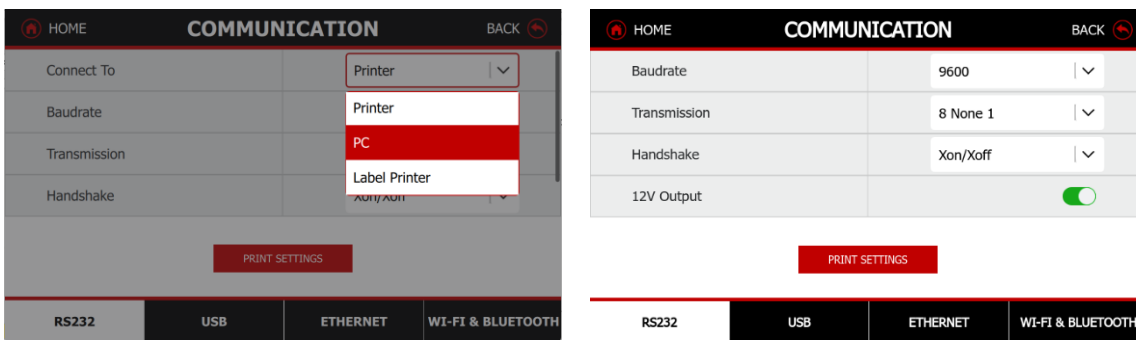

5.13.2 RS232 (DB9) Pin Connections

- Pin 2: Balance transmit line (TxD)
- Pin 3: Balance receive line (RxD)
- Pin 5: Ground signal (GND)
- Pin 7: Clear to send (hardware handshake) (CTS)
- Pin 8: Request to send (hardware handshake) (RTS)

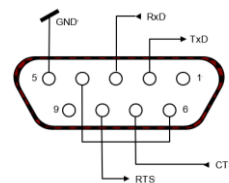

5.13.3 Connections for the Label Printer

All templates including the default template can be edited via OHAUS Label Designer. Please go to the website below to download the software. For how to use the software, please contact an authorized dealer to obtain the software's instructions. Overall, 5 label templates can be stored in the balance.

- When the user selects Label Printing, the Label Template menu appears with default selection, "100mm x 75mm".
 - ◆ This function is compatible with any label printer using the ZPLII programming language. We recommend Zebra printer with RS232 port.

- ◆ **#1-100mm x 75mm**, which is designed based on label size “100mm x 75mm”. This template includes all basic information “Data/Time”, “Sample ID”, “Sample Name”, “Batch ID”, “Result”, “Gross Weight”, “Tare Weight”, “Net Weight”, and “User Name”.
- ◆ **#2-100mm x 10mm**, which is designed for small label size “100mm x 10mm” with weighing result only.
- To select another label template, touch the other numbers. Templates #3 - #5 are empty templates in Explorer until they are edited by OHAUS label Designer and written to the balance.

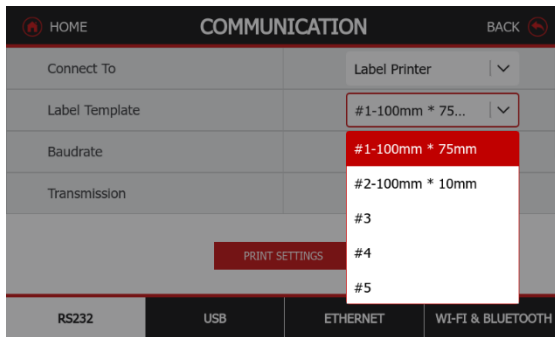

5.13.4 USB

The USB setting can individually setup the USB port to different setup appropriate peripheral device before transferring data.

- Option 1: USB Type B connection with the balance to PC or Transfer Data Direct to Microsoft Excel.
- Option 2: USB Type C connection with the balance to PC or Transfer Data Direct to Microsoft Excel.
- The format can be set in column or cell, see the detail print format in section of Print Setting xxx

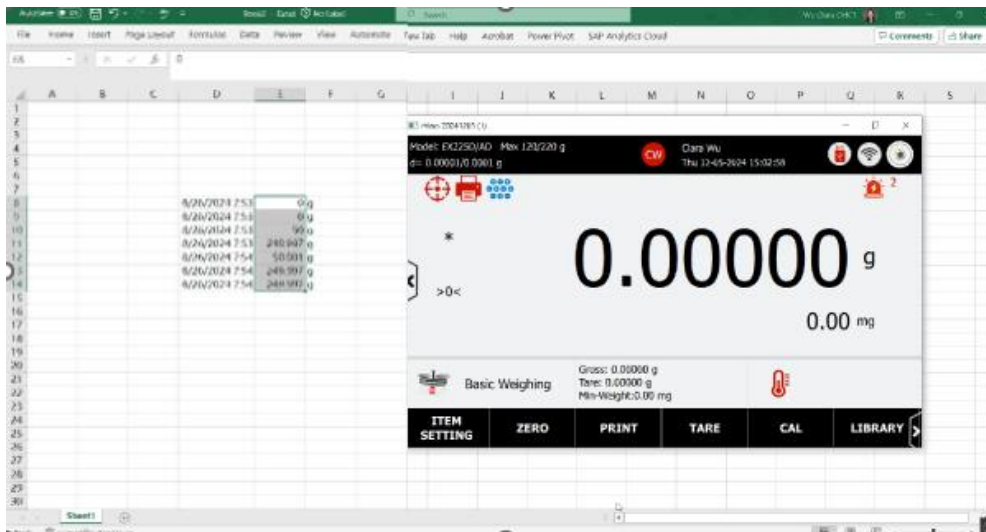

5.13.5 Ethernet

Using the Ethernet Port to connect to a Local Area Network. After successfully connection of the Ethernet cable with the balance, the user can set up the Ethernet options in the Communication Menu.

- **DHCP:** When connecting to a local area network (LAN) or a wireless network and the IP address is unknown, user can use DHCP to automatically obtain an IP address. Enable DHCP: the balance will automatically obtain IP, other ethernet settings will be locked.
- If you prefer to use a static IP address for the connection, you should disable DHCP and manually enter the IP address.

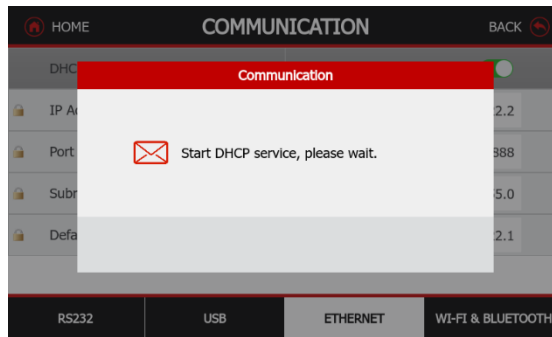
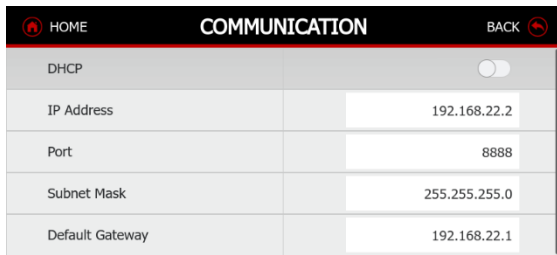

5.13.6 WI-FI & Bluetooth

The Explorer Plus balance uses LMB842 USB dongle to connect BT and Wi-Fi function.

- The LM842 USB Dongle complies with Bluetooth® 5.0 (Dual Mode) and IEEE 802.11ac WiFi Standards of operation. Refer to Section 11.1 for detailed information on specification of the LM842 USB Dongle.

Bluetooth Connection

- The user needs to enter the Bluetooth name to pair with another PC's Bluetooth.
- Once the balance connects to a Bluetooth device, an icon will appear in the upper right corner of the main screen.
- MAC address is used to identify the same Bluetooth device name

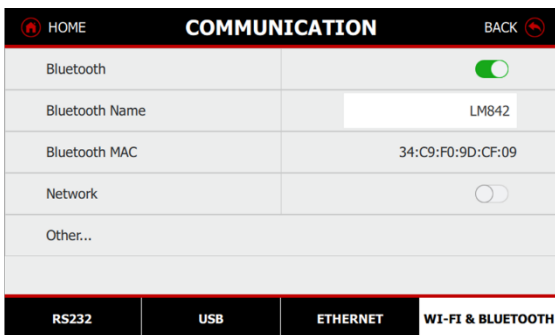

Wi-Fi Connection

- First, the user needs to enable the Network function. The balance will then search for available networks.
- Enter the password to pair and connect to the Wi-Fi.
- If the network is not visible, the user can press the "Other..." button to manually add the network.
- Once the balance connects to Wi-Fi, an icon will appear in the upper right corner of the main screen.

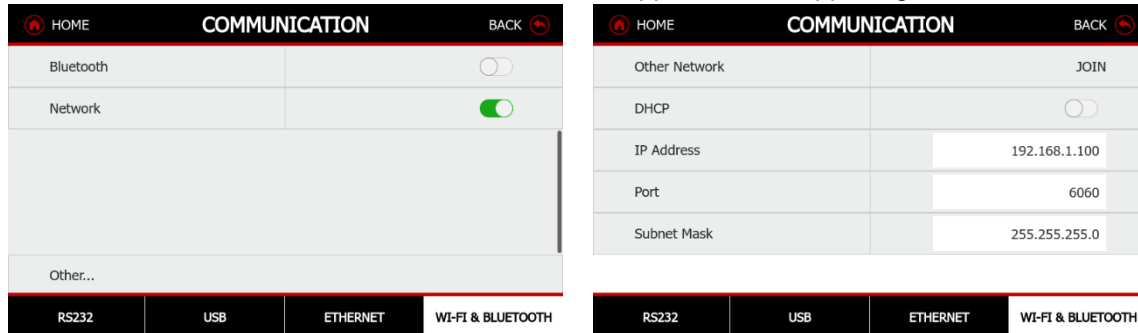

- **DHCP:** When connecting to a local area network (Wi-Fi) or a wireless network and the IP address is unknown, user can use DHCP to automatically obtain an IP address. Enable DHCP: the balance will automatically obtain IP, other ethernet settings will be locked.
- If you prefer to use a static IP address for the connection, you should disable DHCP and manually enter the IP address.

6 Print Settings

Users can configure this function individually based on their specific application requirements. The function allows users to select from the following settings:

- **Print Content:** Customize the content to be printed, including all desired results and titles along with the weighing value.
- **Connect to Printer:** Specify the data to be sent to the printer.
- **Connect to PC:** Specify the data to be transmitted to the PC.
- **Data to Excel:** Format the layout of the data that is sent directly to Microsoft Excel.
- **Save to USB:** Determine how data is saved to a USB flash device, such as the data format and whether the process is manual or automatic.

Note: When the balance is turned on in the Legal For Trade mode, the print settings will immediately be changed to comply with relevant Weights and Measures Regulation, such as those of the International Organization of Legal Metrology (OIML), the National Type Evaluation Program (NTEP) and other local approval agencies.

Refer to Section 9.1 for detailed information on Legal for Trade Setting.

6.1 Print Content

Access this sub-menu to specify the content of the printed data. Users can toggle the content on or off. The Print Review function will directly provide a layout template based on the selected options. The selected content use for “Connect to PC”, “Connect to Printer”, “Save to USB” PDF file.

The available print contents:

- Select All
- Date and Time, Balance ID and Balance name
- User ID, First Name/ Last Name
- Project Name
- Application Mode
- Sample Name, Sample ID
- Batch ID, Lot ID
- Customized IDs
- Result
- Gross, Net, and Tare
- Signature Line
- Verified Line
- Feeds Lines (1, 4, 10)

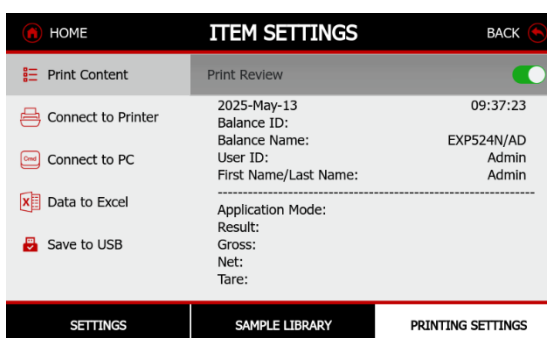
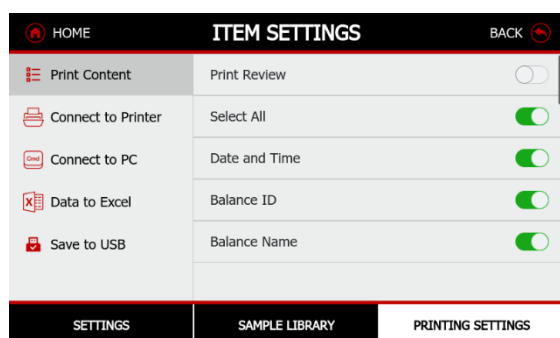

6.2 Connecting to a Printer

Numeric Only

On = Print only the numeric weight value.

Off = Print all the weighing value that enabled in the Print Content.

Single Header Only

When the user switches this to ON, the Header line will be printed only once every 24 hours. The header line includes the following elements:

- Date and Time, Balance ID, and Balance Name
- Project Name
- Application Mode
- Sample Name, Sample ID
- Batch ID, Lot ID
- Customized IDs

Manual Print

Stable only = Print only the stable value

All values = Print all values

Auto Print

Off = disabled

On Stability = printing occurs each time the stability criteria are met.

Interval = printing occurs at the defined time interval (1 to 3600 seconds)

Continuous = printing occurs continuously.

When ON STABLE is selected, set the conditions for printing.

- LOAD = Prints when the displayed load is stable.
- LOAD ZERO = Prints when the displayed load or zero reading is stable.
- When Approved Mode is On, users can only print stable only values

6.3 Connecting to a PC

Output Format

Users can choose the output format based on various output strings.

- OHAUS
- SICS = MT-SICS
- ST =ST-SICS (10)

Manual Print

Stable only = Print only the stable value

All values = Print all values

Auto Print

Off = disabled

On Stability = printing occurs each time the stability criteria are met.

Interval = printing occurs at the defined time interval (1 to 3600 seconds)

Continuous = printing occurs continuously.

When ON STABLE is selected, set the conditions for printing.

- LOAD = Prints when the displayed load is stable.
- LOAD ZERO = Prints when the displayed load or zero reading is stable.
- When Approved Mode is On, users can only print stable only values

6.4 Data to Excel

The balance supports HID (Human Interface Device) connection to a computer without the need for drivers.

The format:

DD-MMM-YYYY	Weight	Units
15-May-2025	100.0000	g

Manual Print

Stable only = Print only the stable value

All values = Print all values

Auto Print

Off = disabled

On Stability = printing occurs each time the stability criteria are met.

Interval = printing occurs at the defined time interval (1 to 3600 seconds)

Continuous = printing occurs continuously.

When ON STABLE is selected, set the conditions for printing.

- LOAD = Prints when the displayed load is stable.
- LOAD ZERO = Prints when the displayed load or zero reading is stable.
- When Approved Mode is On, users can only print stable only values

Text to

Direct to Excel Function:

- Column: Print all data into a single column in Microsoft Excel.
- Cell: Print all data into a single cell in Microsoft Excel.

6.5 Save to USB

- Off = Disable save to USB
- Manual = Save to USB manually
- Auto = Auto save to USB
 - Once the user has set the auto-print interval time, the data will be sent to the USB flash drive at the specified intervals.
 - The PDF format is not allowed when in Auto Save mode
- Format
 - PDF
 - CSV

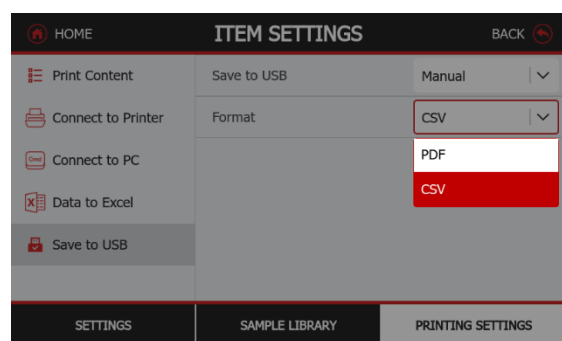

6.5.1 Application Print Out Template

Basic Weighing	Parts Counting	Check Counting
2025-Apr-08 09:31:46	2025-Apr-08 10:13:34	2025-Apr-08 10:17:42
Balance ID:	Balance ID:	Balance ID:
Balance Name:	Balance Name:	Balance Name:
User ID: Admin	User ID: Admin	User ID: Admin
First Name/Last Name: Admin	First Name/Last Name: Admin	First Name/Last Name: Admin
Project Name: PN058	Project Name: PN070	Project Name: PN081
-----	-----	-----
Application Name: Basic Weighing	Application Name: Parts Counting	Application Name: Check Counting
Sample Name: SN058	Sample Name: SN070	Sample Name: SN081
Sample ID: S058	Sample ID: S070	Sample ID: S081
Batch ID: B058	Batch ID: B070	Batch ID: B081
Lot ID: L058	Lot ID: L070	Lot ID: L081
Customer ID1: C1	Customer ID1: C1	Customer ID1: C1
Customer ID2: C2	Customer ID2: C2	Customer ID2: C2
Customer ID3: C3	Customer ID3: C3	Customer ID3: C3
Customer ID4: C4	Customer ID4: C4	Customer ID4: C4
Customer ID5: C5	Customer ID5: C5	Customer ID5: C5
Customer ID6: C6	Customer ID6: C6	Customer ID6: C6
Customer ID7: C7	Customer ID7: C7	Customer ID7: C7
Customer ID8: C8	Customer ID8: C8	Customer ID8: C8
Customer ID9: C9	Customer ID9: C9	Customer ID9: C9
Customer ID10: C10	Customer ID10: C10	Customer ID10: C10
Result: 3.5275	Result: 25 PCS	Result: 74 PCS
oz N	Gross: 78.48 g	Status: Accept
Gross: 6.2960	Net: 78.48 g N	Gross: 178.49 g
oz	Tare: 0.00 g T	Net: 178.49 g N
Net: 3.5275 oz N	Library: Library 070	Tare: 0.00 g T
Tare: 2.7690 oz T	APW: 3.124 g	Library: Library 081
Library: Library 058	Samples: 10 PCS	APW: 2.412 g
Signature: _____	Signature: _____	Samples: 81 PCS
Verify By: _____	Verify By: _____	Over: 254 PCS
		Under: 51 PCS
		Signature: _____
		Verify By: _____

Percent Weighing		Check Weighing		Dynamic	
2025-Apr-08	13:30:04	2025-Apr-08		2025-Apr-08	13:36:21
Balance ID:		13:33:25		Balance ID:	
Balance Name:		Balance ID:		Balance Name:	
User ID :	Admin	Balance Name:		User ID:	Admin
First Name/Last Name:		User ID:	Admin	First Name/Last Name:	
Project Name:	PN010	First Name/Last Name:		Project Name:	PN055
-----		Project Name:	PN028	-----	
Application Name:	Percent Weighing	-----		Application Name:	Dynamic Weighing
Sample Name:	SN010	Application Name:	Check Weighing	Sample Name:	SN055
Sample ID:	S010	Sample Name:	SN028	Sample ID:	S055
Batch ID:	B010	Sample ID:	S028	Batch ID:	B055
Lot ID:	L010	Batch ID:	B028	Lot ID:	L055
Customer ID1:	C1	Lot ID:	L028	Customer ID1:	C1
Customer ID2:	C2	Customer ID1:	C1	C2:	C2
Customer ID3:	C3	Customer ID2:	C2	Customer ID3:	C3
Customer ID4:	C4	Customer ID3:	C3	Customer ID4:	C4
Customer ID5:	C5	Customer ID4:	C4	Customer ID5:	C5
Customer ID6:	C6	Customer ID5:	C5	Customer ID6:	C6
Customer ID7:	C7	Customer ID6:	C6	Customer ID7:	C7
Customer ID8:	C8	Customer ID7:	C7	Customer ID8:	C8
Customer ID9:	C9	Customer ID8:	C8	Customer ID9:	C9
Customer ID10:	C10	Customer ID9:	C9	Customer ID10:	C10
Result:	361.69 %	Customer ID10:	C10	Result:	367.00 g
Gross:	198.93 g	Result:	Accept	Gross:	198.93 g
Net:	198.93 g N	Gross:	198.92 g	Net:	198.93 g N
Tare:	0.00 g T	Net:	198.92 g N	Tare:	0.00 g T
		Tare:	0.00 g T		
Library:	Library 010			Library:	Library 055
Reference Weight:	550.00 g	Library:	Library 028	Averaging Time:	3 seconds
Reference Adjust:	10.0 %	Over Limit:	214.25 g		
Difference Weight:	143.93 g	Under Limit:	12.54 g	Signature:	_____
Difference Factor:	261.69 %			Verify By:	_____
Signature:	_____	Signature:	_____		
Verify By:	_____	Verify By:	_____		

Totalization		Formulation		Differential	
2025-Apr-08	15:11:42	2025-Apr-08		2025-Apr-08	19:58:46
Balance ID:		16:30:04		Balance ID:	
Balance Name:		Balance ID:		Balance Name:	
User ID:	Admin	Balance Name:		User ID:	Admin
First Name/Last Name:		User ID:	Admin	First Name/Last Name:	
Project Name:	PN072	First Name/Last Name:		Project Name:	
-----		Project Name:		-----	
Application Name:	Totalization	-----		Application Mode:	Differential
Sample Name:	SN072	Application Name:	Formulation	Result:	3.89[3] g N
Sample ID:	S072	Result:	199.09 g N	Gross:	18.42[0] g
Batch ID:	B072	Gross:	299.09 g	Net:	3.89[3] g N
Lot ID:	L072	Net:	199.09 g N	Tare:	14.52[7] g T
Customer ID1:	C1	Tare:	100.00 g T	Start Time:	2025-Apr-08 19:57:07
Customer ID2:	C2	Recipe:	Recipe 001	End Time:	2025-Apr-08 19:58:41
Customer ID3:	C3	Item Name	Item Weight	Reciprocal Proportion	On
Customer ID4:	C4	Item 1	100.00 g	Absolute Value	On
Customer ID5:	C5	Item 2	199.08 g	Item Name:	ITEM1
Customer ID6:	C6	Start Time:	12-26-2024 16:29:44	Initial Weight:	0.766 g
Customer ID7:	C7	End Time:	12-26-2024 16:30:01	Final Weight:	0.760 g
Customer ID8:	C8	-----Sample Data-----		Difference Weight:	0.006 g
Customer ID9:	C9	Item Name:	Item 1	Different Percent:	0.8 %
Customer ID10:	C10	Target Weight:	100.00 g	Item Name:	ITEM2
Result:	278.33 g	Actual Weight:	100.00 g	Initial Weight:	1.528 g
Gross:	0.00 g	Difference:	0.00 %	Final Weight:	1.534 g
Net:	0.00 g N	Item Name:	Item 2	Difference Weight:	0.006 g
Tare:	0.00 g T	Target Weight:	199.08 g	Different Percent:	0.4 %
Library:	Library 072	Actual Weight:	199.08 g	Item Name:	ITEM3
Start Time:	12-26-2024 15:08:29	Difference:	0.00 %	Initial Weight:	2.292 g
End Time:	12-26-2024 15:11:42	Total Weight:	299.08 g	Final Weight:	2.325 g
-----Sample Data (g)-----		Signature: _____		Difference Weight:	0.033 g
'1:	198.93	Verify By: _____		Different Percent:	1.4 %
'2:	19.85			Item Name:	ITEM4
'3:	19.86			Initial Weight:	3.094 g
'4:	19.87			Final Weight:	3.110 g
'5:	19.88			Difference Weight:	0.016 g
Samples:	5			Different Percent:	0.5 %
Average:	55.67 g			Item Name:	ITEM5
Maximum:	198.93 g			Initial Weight:	3.871 g
Minimum:	19.85 g			Final Weight:	3.893 g
Range:	179.08 g			Difference Weight:	0.022 g
Standard Deviation:	71.63 g			Different Percent:	0.6 %
Relative Deviation(std%):	128.68 %			Signature: _____	
Signature: _____				Verified By: _____	
Verify By: _____					

Density Determination		Peak Hold		Pipette Adjustment	
2025-Apr-08	20:01:25	2025-Apr-08	20:25:41	2025-Apr-08	20:11:58
Balance ID:		Balance ID:		Balance ID:	
Balance Name:		Balance Name:		Balance Name:	
User ID:	Admin	User ID:	Admin	User ID:	Admin
First Name/Last Name:		First Name/Last Name:		First Name/Last Name:	
-----		-----		Project Name:	
Application Mode:	Density Determination	Application Mode:	Peak Hold	-----	
Result:	7.435 g/cm ³	Result:	355.512 g	Application Mode:	Pipette Adjustment
Gross:	19.44[1] g	Gross:	0.000 g	Result:	Pass
Net:	4.91[4] g N	Net:	0.000 g N	Gross:	24.76[4] g ?
Tare:	14.52[7] g T	Tare:	0.000 g T	Net:	1.01[1] g ? N
				Tare:	23.75[3] g T
Weight in air.:	5.67[4] g	On Stability:	No	Start Time:	2025-Apr-08 20:09:03
Weight in liquid.:	4.91[3] g	Signature: _____		End Time:	2025-Apr-08 20:11:52
Auxiliary liquid.:	Water	Verified By: _____		Liquid Density:	0.99823 g/cm ³
Liquid Density:	0.99823 g/cm ³			Pressure:	1.0 ATM
Water Temp.:	20.0 °C			Pipette Test Method:	Method 001
Porous Material:	Off			Nominal Inaccuracy Imprecision Number	
Signature: _____				1000 ul	5.00 % 5.00 % 3
Verified By: _____				Pipette Test Results	

				Pipette Name:	pip001
				Pipette Number:	
				Nominal Volume:	1000 ul Pass
				-----Sample Data-----	
				1	1023 ul 1.021 g
				2	1032 ul 1.030 g
				3	1016 ul 1.014 g
				Inaccuracy	
				E%:	2.64 %
				E% Limit:	5.00 %
				Average:	1026 ul
				Imprecision	
				CV%:	0.97 %
				CV% Limit:	5.00 %
				Standard Deviation:	10 ul
				> +2S:	0.00 % , 0
				> +1S:	0.00 % , 0
				+1S > Mean > -1S:	0.00 % , 0
				< -1S:	0.00 % , 0
				< -2S:	100.00 % , 10
				Signature: _____	
				Verified By: _____	

SQC		Fill Weight Variation		Flow Rate Control	
2025-Apr-08	20:13:55	2025-Apr-08	20:17:46	2025-Apr-08	19:49:45
Balance ID:		Balance ID:		Balance ID:	
Balance Name:		Balance Name:		Balance Name:	
User ID:	Admin	User ID:	Admin	User ID:	Admin
First Name/Last Name:		First Name/Last Name:		First Name/Last Name:	
Project Name:		Project ID:		Project Name:	
-----		-----		-----	
Application Mode:	SQC	Application Mode:	Fill Weight Variation	Application Mode:	Flow Rate Control
Result:	Accept	Sample Name:		Result:	
Average:	100.010 g	Sample ID:		Max Flow Rate:	0.543 ml/min
Minimum:	100.010 g	Batch ID:		Min Flow Rate:	0.526 ml/min
Maximum:	100.011 g	Lot ID:		Average Flow Rate:	0.533 ml/min
Standard Deviation:	0.000 g	Samples:	5	Pump Cycle:	3 times
Test Result:		Unit1:	100.01[1] g	Test Result:	
Sample ID Weight T1/T2		Unit2:	100.01[1] g	1:	0.529 ml/min
Sample 001 100.011 g >=-T1 & <=+T1		Unit3:	100.01[1] g	2:	0.526 ml/min
Sample 002 100.010 g >=-T1 & <=+T1		Unit4:	100.01[1] g	3:	0.543 ml/min
Sample 003 100.010 g >=-T1 & <=+T1		Unit5:	100.01[1] g	Pump Speed:	0.500 ml/min
Batch:	Batch 01	Difference:		Liquid Density:	0.99823 g/ml
Number in Batch:	100% Inspection	1: 0.00[3] g 0.00 %		Target Volume:	10.00 ml
Inspection Quantity:	3	2: 0.00[3] g 0.00 %		Number of Pump Cycles:	3 times
Tare Mode:	Off	3: 0.00[3] g 0.00 %		Mode:	Flow Rate Control
Pretare:	0.000 g	4: 0.00[3] g 0.00 %		Signature:	_____
Sample Type:	Solid	5: 0.00[3] g 0.00 %		Verified By:	_____
EU Criteria:	Off	Result:			
Nominal Weight:	100.000 g	Accept:	5 Units		
+T1:	0.300 g	Fail:	0 Units		
-T1:	-0.300 g	Acceptance Criteria:	Off		
+T2:	0.600 g	Average Weight:	100.00[8] g		
-T2:	-0.600 g	+/- Limit %:	7.50 %		
Signature:	_____	Signature:	_____		
Verified By:	_____	Verified By:	_____		

6.6 Printout Examples

Here are the examples for each application displayed with all items enabled in the Print Content menu. The default values for Header lines 1-5 are also indicated.

Notes:

- When the user management and electronic signature are active, the User ID will display in the Signature Line. The electronic signature is disabled by default.
- When a library is activated, "Library Name:" will appear below "Application" in the printout.

6.6.1 Calibration Report Template

Internal Calibration	Span Calibration	Repeatability Test																								
Calibration Report -----Internal Calibration----- Date and Time: 2025-May-12 10:34:02 Balance ID: Balance Name: EXP224/AD Result: 0.0000g Difference Internal Calibration Successful Signature: User ID Verified By: _____	Calibration Report -----Span Calibration----- Date and Time: 2025-May-12 10:34:02 Balance ID: Balance Name: EXP224/AD Result: 0.0000g Difference Span Calibration Successful Signature: User ID Verified By: _____	Routine Test: Repeatability Test Date: 2025-Apr-11 Start Time: 19:13:45 End Time: 19:15:52 Test Weights ID: Test Weights Value: 25.00000 g Test Weights Class: Test Result: <table border="1"> <thead> <tr> <th>Number</th> <th>Zero Load</th> <th>Full Load</th> </tr> </thead> <tbody> <tr> <td>1</td> <td>0.00000 g</td> <td>25.00496 g</td> </tr> <tr> <td>2</td> <td>-0.00002 g</td> <td>25.00262 g</td> </tr> <tr> <td>3</td> <td>-0.00013 g</td> <td>25.00063 g</td> </tr> <tr> <td>4</td> <td>-0.00006 g</td> <td>25.01753 g</td> </tr> <tr> <td>5</td> <td>0.00001 g</td> <td>25.00375 g</td> </tr> <tr> <td>6</td> <td>0.00002 g</td> <td>25.00014 g</td> </tr> <tr> <td colspan="2">SD (Span):</td> <td>0.006441 g</td> </tr> </tbody> </table> Signature: _____ Verified By: _____	Number	Zero Load	Full Load	1	0.00000 g	25.00496 g	2	-0.00002 g	25.00262 g	3	-0.00013 g	25.00063 g	4	-0.00006 g	25.01753 g	5	0.00001 g	25.00375 g	6	0.00002 g	25.00014 g	SD (Span):		0.006441 g
Number	Zero Load	Full Load																								
1	0.00000 g	25.00496 g																								
2	-0.00002 g	25.00262 g																								
3	-0.00013 g	25.00063 g																								
4	-0.00006 g	25.01753 g																								
5	0.00001 g	25.00375 g																								
6	0.00002 g	25.00014 g																								
SD (Span):		0.006441 g																								

6.6.2 Export to PDF for Batch Printing Example

Export to PDF

EXPLORER BALANCEPAGE 1

BATCH PRINTING RESULTS

Date and Time:2025-Jul-02 07:45:34

Balance ID:C525192348

Balance Name:EXP224/AD

User ID:Admin

First Name/Last Name:Admin

Sample Name:TARA

Sample ID:250

EMAIL:TARA.YAO@OHAUS.COM

SAMPLE ID	WEIGHT	DATE	TIME
001	2.6878 g	2025-Jul-02	07:45:22
002	2.6878 g	2025-Jul-02	07:45:22
003	2.6878 g	2025-Jul-02	07:45:23
004	2.6877 g	2025-Jul-02	07:45:26

/EXP224_AD/Weighing_Data/2025-Jul-02/

7 Library

Each Explorer Plus balance is equipped with an advanced library function that makes it easy to create, edit, and activate libraries within seconds. The substantial memory capacity accommodates up to 15 weighing application modes and can store 3000 library records.

In the Library menu, users can review the list of libraries they have generated for various application modes. These libraries can be exported to PC software and imported whenever necessary.

In the upper right corner, the total library memory is displayed. For instance, 9/1% indicates that 9 libraries have been created and are occupying approximately 1% of the total capacity. When the memory usage reaches 80%, the balance will display a message prompting the user to delete or back up library records.

Note:

The library name will change to Method, Recipe and Batch according to different application modes.

HOME		LIBRARY			3 / 1%
LIBRARY ID	USER ID	APPLICATION	SAMPLE NAME	DATE AND TIME	
Library 003	Admin	Basic Weighing		2025-Aug-29 13:58:33	
Library 002	Admin	Basic Weighing		2025-Aug-29 13:58:31	
Library 001	Admin	Basic Weighing		2025-Aug-29 13:58:03	
< 1 / 1 >					
DELETE ALL		IMPORT LIBRARY		EXPORT LIBRARY	

7.1 Library Data

The library can hold up to 3000 records in total. The following data is stored for the Application used:

Application Mode	Library Function	Data Specific to Application Modes	Sample Data
Basic Weighing	Yes	Minimum Weight	Sample Name Sample ID Batch ID Lot ID Project Name 10 x Customer IDs
Parts Counting	Yes	APW, Sample Size	
Check Counting	Yes	APW, Sample Size, Over Limit, Under Limit	
Percent Weighing	Yes	Reference weight, Reference adjust	
Check Weighing	Yes	Over Limit, Under Limit, Nominal Weight, +Weight Tolerance, -Weight Tolerance, +Percent Tolerance, -Percent Tolerance	
Dynamic Weighing	Yes	Average Time	
Totalization	Yes		
Density Determination	Yes	Sinker Volume, Water Temp., Liquid Density, Oil Density	
Peak Hold	Yes		
Formulation	Recipe*	Recipe Name, Item Name, Item Weight	
Differential Weighing	No Library		

Pipette Adjustment	Method*	Method Name, Nominal, Pipette Name, Pipette Number, Inaccuracy, Impression, Number of Samples	N/A
SQC	Batch*	Number in Batch, Inspection Quantity, Tare Mode, Sample Type, EU Criteria, Nominal Weight +T1, -T1, +T2, -T2	Sample Name Sample ID Batch ID Lot ID Project Name 10 x Customer IDs
Fill Weight Variation	No Library		
Flow Rate Control	Yes	Pump Speed, Pump Time, Liquid Density, Target Volume	Sample Name Sample ID Batch ID Lot ID Project Name 10 x Customer IDs

*Notes:

- Up to 25 methods can be stored in the Pipette Adjustment application.
- Up to 25 recipes can be stored in the Formulation/Recipe-based application.
- Up to 25 batches can be stored in the SQC application, with the ability to perform statistics on 5 open batches.

7.2 Import and Export Library

Users can import a "library.db" file into the balance.

- Save the "library.db" file to a USB flash drive. Connect the USB drive to the balance. Once connected, the IMPORT button will become active.
- Press the IMPORT button to initiate the import process.

Users can export a "library.db" file to a USB flash device.

- Connect the USB flash drive to the balance. Once connected, the EXPORT button will become active.
- Press the EXPORT button to download the "library.db" file to the USB flash device.

Note:

- In the import process, the library will be renamed if import the same library name in the USB flash driver.

8 Maintenance

This function allows a user to diagnose hardware functions, update software, review the service log file, and provide service technicians access to the service menu.

Notes:

- Service Menu is locked to prevent authority change make the incorrect weighing performance.
- If you encounter any issues while using the balance, please contact Ohaus or your local Ohaus dealer for assistance.

8.1 Maintenance Menu

User can diagnose hardware functions, such as Auto Door, IR sensor, Digital Leveling Bubble, Terminal Status Lights, Draftshield Lights, and Fingerprint Accessory if connected.

Auto Doors: Press **Auto Doors** to start testing. If this function is working properly, the doors will open and then close automatically.

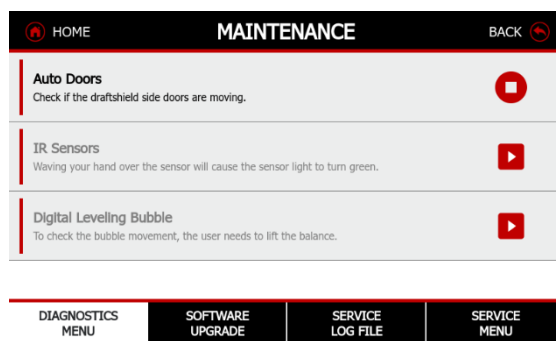

IR Sensors: Press **IR Sensors** to start testing. Waving your hand over it will trigger that function and cause the sensor light to turn green. When the function is working properly, the status icon on the right side will turn green.

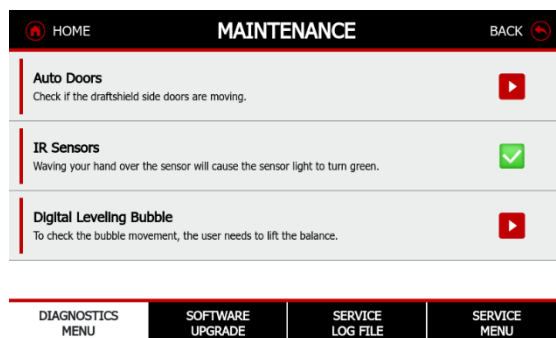

Digital Leveling Bubble: To check the bubble movement, the user needs to lift the balance. When the function is working properly, the status icon on the right side will turn green. If the leveling bubble is not moving, the status icon will display a warning sign.

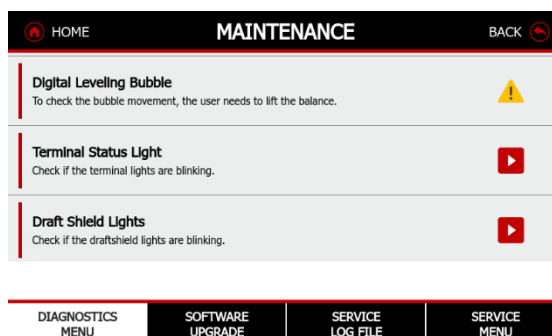
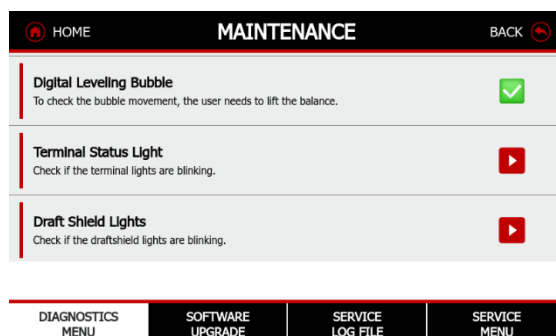

Terminal Lights: Press **Terminal Lights** button to check if the lights are functioning. The balance will cycle through all the light colors on the terminal.

Draft Shield Lights: Press **Draft Shield Lights** button to check if the lights are functioning. The balance will cycle through all the light colors in the draft shield.

Fingerprint: Press **Fingerprint** button to check if the accessory is functioning. When the function is working properly, the balance will identify the serial number of the fingerprint module.

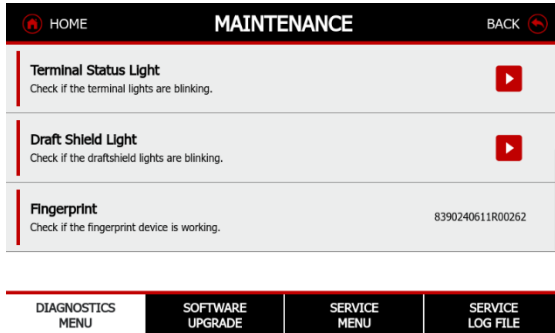

8.2 Software Upgrade

In this function, users need to obtain the correct software to upgrade the balance for feature enhancements or bug fixes. If you encounter any issues while using the balance, please contact Ohaus or your local Ohaus dealer for assistance.

8.2.1 Software Upgrade Process

- Save the upgrade file into a USB flash drive.
- Connect the USB flash drive to the Balance.
- Press START button to upgrade the system.
- When completed, the balance will reboot automatically.

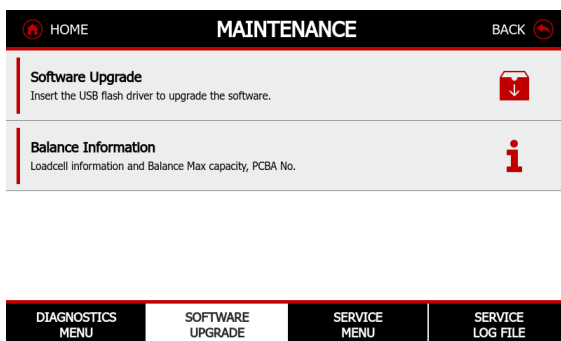

8.2.2 Balance Information

This screen will provide essential information for the balance.

8.3 Service Menu

Service Menu is locked to prevent unauthorized changes resulting in incorrect weighing performance. If you encounter any issues while using or service the balance, please contact Ohaus or your local Ohaus dealer for assistance.

8.4 Service Log File

The Service Log file is record the balance Failure log, System Log, Calibration Log, Printed Data Log

- Failure Log: 100 electronic records of the number of times an overload /underload occurs.
- System Log: 100,000 entries which contain electronic records of the menu change on the balance, create/delete user, log in/off, date and time change etc. Only Administrator and supervisor can be export to PDF as the un-editable format.
- Calibration Log: 3000 electronic records of the user performed calibration reports and service performed calibration reports. Only Administrator and supervisor can export to PDF as the un-editable format.
- Printed Data Log: 100,000 electronic records of the routine weighing data that is sent either by manually pressing the print key or through a command from a PC.

8.5 Factory Reset

Use this sub-menu to reset the menus to their Factory default settings.

- Reset All
- Fingerprint
- Quick Setup
- Calibration
- Balance Setup
- Application Modes
- Weighing Units
- Communication
- Library

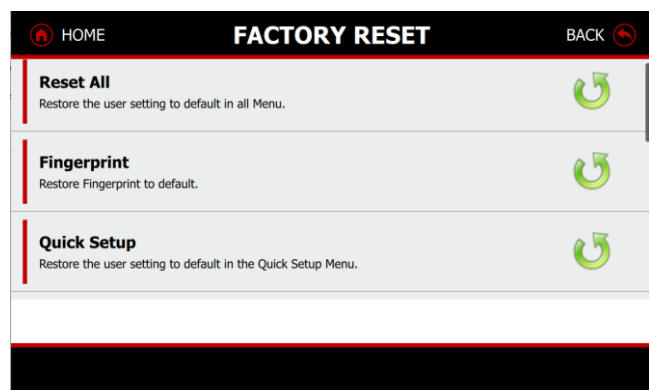

8.6 Log Off

Press this button to log out of the current user account.

8.7 Power Off

Press this button to turn off the balance.

9 Legal For Trade Application

When the balance is used in trade or a legally controlled application it must be set up, verified and sealed in accordance with local weights and measures regulations. It is the responsibility of the purchaser to ensure that all pertinent legal requirements are met.





*For Explorer Plus...N...models, please refer to Legal for Trade Settings.

9.1 Legal for Trade Setting

Before verification and sealing, perform the following steps in Order:

- Verify that the menu settings meet the local weights and measures regulations.
- Weighing Unit menu should be reviewed. Verify the units turned On meet the local weights and measures regulations.
- Perform a calibration as explained in 5.4 Calibration.
- Set the position of the Legal for Trade Switch to the locked position.

■ Legal for Trade Switch:

	Explorer Plus Analytical and Precision Balance	Explorer Plus High-Capacity Balance
Position		
Lock/Unlock		

- Set Legal for Trade to ON in the Balance Setup menu (refer to Approved Mode in section 5.5.13).

9.2 Balance Setting Changes

When Legal for Trade is set to ON, the menu settings are affected as follows:

Menu	Changes
Calibration Menu	<ul style="list-style-type: none"> • Internal Calibration will be locked at On. For EXP...N... models: <ul style="list-style-type: none"> ○ If Internal Calibration is Off before turning on Approved Mode, the Internal Calibration field in Calibration Settings will be locked at Off. ○ If Internal Calibration is On before turning on Approved Mode, the field and tab will remain unchanged. • AutoCal™ will be locked at its current setting. • AutoCal™ Interval (Hours) will be locked at current setting. • Span Calibration will be locked at off and greyed out.
Balance Setup Menu	<ul style="list-style-type: none"> • Auto Zero Tracking is limited to 0.5d or Off. • If AZT is Off before turning on Approved Mode, then the field will be locked at “Off”. • If AZT is on before turning on Approved Mode, the field will be forced to “0.5d” and locked. • Gross Indicator will be locked at the current setting. • Graduations will be forced to 1 Division and the field will be hidden. • For EXP...N...models, graduations will be locked at its current setting. • In System Log menu, Auto Login will be locked at Off.
Maintenance Menu	<ul style="list-style-type: none"> • Software Upgrade will be locked at Off. • Service Menu will be locked at Off.
Weighing Units Menu	<ul style="list-style-type: none"> • Units will be restricted to metric units. • For EXP...N...models, Units will be restricted to metric and imperial units.
Printing Settings Menu	<ul style="list-style-type: none"> • In Connect to Printer, Numeric Only will be locked at off, and Manual Print will be locked at Stable only. • In Connect to PC, Numeric Only will be locked at off, and Manual Print will be locked at Stable only. • In Data to Excel, Manual Print will be locked at Stable only
Terminal Setting:	<ul style="list-style-type: none"> • After turning on Approved Mode, it will not be allowed to switch terminal.
Applications	<ul style="list-style-type: none"> • In Item Settings menu, Auto Tare will be locked at Off.

9.3 Verification

The calibration weights and measures official or authorized service agent must perform the verification procedure.

9.4 Sealing

After the Balance has been verified, it must be sealed to prevent undetected access to the legally controlled settings. Before sealing the device, ensure that the security switch is in the Locked position and the Legal for Trade setting in the Balance Setup menu has been set to ON.

If using a wire seal, pass the sealing wire through the holes in the security switch and Bottom Housing as shown.

If using a paper seal, place the seal over the security switch and Bottom Housing as shown.

- Semi-Micro, Analytical and Precision Balance



- High-Capacity Balance



9.5 Output Format

Strings Definition

Field:	Label ¹	Space ²	Weight ³	Space ²	Unit ⁴	Space	Stability ⁵	Space	G/N ₆	Space	Term. Characters ⁷
Length:		1	11	1		1	≤ 1	≤ 1	≤ 3	0	≤ 8

- In certain cases, a Label field of up to 11 characters is included.
- Each field is followed by a single delimiting space (ASCII 32).
- The Weight field is 9 right justified characters. If the value is negative, the “-” character is located at the immediate left of the most significant digit.
- The Unit field contains the unit of measure abbreviation up to 5 characters.
- The Stability field contains the “?” character if the weight reading is not stable. The Stability field and the following Space field are omitted if the weight reading is stable.
- The G/N field contains the net or gross indication. For net weights, the field contains “NET”. For gross weights, the field contains nothing, “G” or “B”, depending on the GROSS INDICATOR menu setting.
- The Termination Characters field contains CRLF, Four CRLF or Form Feed (ASCII 12), depending on the LINE FEED menu setting.

10 MAINTENANCE

10.1 Calibration

Periodically verify calibration by placing an accurate weight on the balance and viewing the result. If calibration is required, perform a Balance internal calibration.

10.2 Cleaning



WARNING: Electric Shock Hazard. Disconnect the equipment from the power supply before cleaning. Make sure that no liquid enters the interior of the instrument.



Attention: Do not use solvents, harsh chemicals, ammonia or abrasive cleaning agents.

The housing may be cleaned with a cloth dampened with a mild detergent if necessary.

10.3 Battery Power



CAUTION: Battery is to be replaced only by an authorized Ohaus service dealer. Risk of explosion can occur if the rechargeable battery is replaced with the wrong type or if it is not properly connected. Dispose of the rechargeable battery according to local laws and regulations.

10.4 Troubleshooting

Symptom / Display	Possible Cause	Remedy
Balance will not turn on	<ul style="list-style-type: none"> No power supply to the Balance 	<ul style="list-style-type: none"> Verify connection and voltage
Inaccuracy weighing results	<ul style="list-style-type: none"> Improper calibration Unstable environment 	<ul style="list-style-type: none"> Perform calibration Move balance to suitable location
Cannot calibrate	<ul style="list-style-type: none"> Calibration Menu locked Approved Mode set to on Instable environment Incorrect calibration masses 	<ul style="list-style-type: none"> Turn Calibration menu lock off Turn Approved Mode off Move balance to suitable location Use correct calibration masses
Cannot change menu settings	<ul style="list-style-type: none"> Sub-menu locked Approved Mode set to on 	<ul style="list-style-type: none"> Unlock sub-menu Turn Approved Mode off
Low Reference Weight	<ul style="list-style-type: none"> Reference weight too small The weight on the pan is too small to define a valid reference weight. 	<ul style="list-style-type: none"> Increase sample size
Invalid Piece Weight	<ul style="list-style-type: none"> Average piece weight is too small 	<ul style="list-style-type: none"> Increase average piece weight
Operation Timeout	<ul style="list-style-type: none"> Weight reading is not stable 	<ul style="list-style-type: none"> Move balance to suitable location
-----	<ul style="list-style-type: none"> Busy (tare, zero, printing) 	<ul style="list-style-type: none"> Wait until completion

10.5 End of Life Instruction

OHAUS electronic balances are precision instruments consisting of a metal housing, coated aluminum weighing cells, stainless steel parts, ABS/PC plastic parts, cardboard and foam packaging, and other materials. Kindly comply with the sustainable instructions for handling the balance when it is not in use or reaches the end of its operational lifespan.

Data Management: Before disposing of the electronic balance, ensure that all sensitive data or user information is erased from the device. Follow the balance instruction manual for data removal or seek OHAUS service engineer provider assistance.

Reuse or Donate: Consider donating your electronic balance to a school, community center, or charitable organization that might have a use for it. Reusing the equipment is the most sustainable option.

Recycling: If the electronic balance is no longer functional or cannot be reused, consider recycling it. Look for electronic recycling centers in your area that accept electronic equipment. Make sure to choose a reputable recycling center that follows proper e-waste disposal regulations. In both the US and the EU, aluminum and stainless steel are considered readily recyclable while ABS/PC plastic can be recycled, but not as easily. In the UK, aluminum, stainless steel, and ABS/PC plastics are considered readily recyclable.

Disposal: If recycling is not an option, dispose of the electronic balance responsibly. Do not throw it in the regular trash, as it can potentially harm the environment. Check with your local waste management authorities for guidance on properly disposing of electronic equipment, such as EU directive 2002/96/EC (WEEE), refer to www.ohaus.com/weee.

Packaging: When transporting the electronic balance for recycling or disposal, use minimal packaging material and consider using eco-friendly packaging options. Avoid single-use plastics and opt for recyclable or biodegradable materials.

Sustainable Alternatives: When purchasing a new electronic balance, choose a product from a manufacturer that prioritizes sustainability.

10.5.1 Material Composition of 1mg, 0.1mg and 0.01mg Draftshield Models

- Material Composition for Explorer Draftshield Models

#	Material Composition	Main Usage	Recycled Materials Ratio	Weight (kilograms)	Ratio to Total Weight (%)
Products	Metal Parts	Housing, Loadcell	100% Aluminum	4.54 kg	41%
	Plastic Parts	Leveling feet, Wing Rings, In-use-cover	50% ABS	1.74 kg	12%
	Glass	Draftshield Doors	N/A	1.58 kg	14%
	Electronic Parts	PCB		0.74 kg	7%
	Fastener	Screws	70% SST	0.08 kg	1%
	Cables	Connections	Copper and Rubber skin	0.12 kg	1%
Packaging	Paper Parts	Carton Box	100% recycle	1.88 kg	17%
	Foams	Shipping Foams	100% EPP	1.32 kg	8%
Total Weights				12 kg	100%

10.6 Service Information

OHAUS prioritizes energy-efficient design, eco-friendly packaging, and other sustainable objectives, reflected in all its laboratory weighing products that incorporate sustainable product goals. By following these sustainable end-of-life instructions, you can ensure that your electronic balance is disposed of in an environmentally friendly and sustainable manner. Thank you for choosing the OHAUS instrument and taking the necessary steps to protect the environment.

If the troubleshooting section does not resolve your problem, contact an Authorized Ohaus Service Agent. Please visit our website www.ohaus.com to locate the Ohaus office nearest you. An Ohaus Product Service Specialist will be available to assist you.

11 TECHNICAL DATA

11.1 Specifications

Ambient Conditions

- Indoor use only
- Altitude: 2000 m
- Specified Temperature range: 10°C to 30°C. Operability is assured at ambient temperatures between 5°C and 40°C. For EXP...4N.. NTEP models the temperature range should be 15°C to 25°C.
- Humidity: Maximum relative humidity 80% for temperatures up to 31 °C decreasing linearly to 50% relative humidity at 40°C.
- Electrical supply:
 - 12VDC, 1.5A. (For use with certified or approved power supply, which must have a SELV and limited energy output.). (For the models powered by external power adapter.)
 - 100 - 240V~, 0.5A, 50/60Hz. (For Explorer Plus High-Capacity models)
- Mains supply voltage fluctuations: up to ±10% of the nominal voltage
- Installation category II
- Pollution degree: 2

Materials

- Bottom Housing;
 - Die-cast Aluminum, Painted
 - IP54 waterproof protected base (EXP24001, EXP35001, and EXP65001)
- Top Housing: Die-cast Aluminum, Painted
- Terminal: Glass, Die-cast Aluminum
- Weighing Platforms:
 - Plastic (PC)
 - Die-cast Aluminum (EXP24001, EXP35001, and EXP65001)
- Weighing Pan:
 - Zink alloy (0.01mg models)
 - 316 SST (0.1mg, 1mg, 0.01g, 0.1g models)
 - 304 SST (EXP24001, EXP35001, and EXP65001)
- In-use Cover: plastic (PET)
- Draft Shield; Glass, Aluminum, Plastic

11.2 Model Specification Tables

MODEL	EXP125D/AD	EXP125/AD	EXP225D/AD	EXP225/AD
	EXP125DM/AD	EXP125M/AD	EXP225DM/AD	EXP225M/AD
Capacity (g)	82 g / 120 g	120 g	120 g / 220 g	220 g
Readability d, fine range (g)	0.01 mg	0.01 mg	0.01 mg	0.01 mg
Readability d, full range (g)	0.1 mg	0.01 mg	0.1 mg	0.01 mg
Repeatability (sd.), ≤5% of full load	0.01 mg	0.01 mg	0.01 mg	0.01 mg
Repeatability (sd.), 5% of full load to fine range max	0.02 mg	0.02 mg	0.02 mg	0.02 mg
Repeatability (sd.), fine range max to full range	0.1 mg	0.02 mg	0.1 mg	0.02 mg
Linearity deviation typical	0.06 mg	0.06 mg	0.06 mg	0.06 mg
Linearity deviation	0.2 mg	0.1 mg	0.2 mg	0.1 mg
Verification interval, e (EXP...M..models only)	1 mg	1 mg	1 mg	1 mg
Approval Class (EXP...M.. models only)	Class I	Class I	Class I	Class I
Span Calibration Points	25g, 50g, 75g, 100g	25g, 50g, 75g, 100g	50g, 100g, 150g, 200g	50g, 100g, 150g, 200g
Weighing units*	15 weighing units: g, mg, ct, N, oz, ozt, Grain, dwt, mo, msg, tcl, tola, baht, Custom 1, Custom 2			
Weighing units* (EXP...M.. models only)	g, mg, ct			
Applications	15 application modes: Basic Weighing, Parts Counting, Check Counting, Percent Weighing, Check Weighing, Dynamic Weighing, Totalization, Formulation, Differential, Density Determination, Peak Hold, Pipette Adjustment, SQC, Fill Weight Variation, Flow Rate Control			
Stabilization time (typical)	0.1 mg: ≤2 seconds; 0.01 mg: ≤ 5 seconds			
Sensitivity Temperature Drift (ppm/K)	0.8			
Min-Weight (typical) (USP, K=2, U=0.10%)	20 mg			
Min-Weight (optimal) (USP, K=2, U=0.10%, SRP≤0.41d)	8.2 mg			
Terminal Display	7-inch TFT 16.7M Color Press Screen with Glass Overlay, Detachable Terminal			
Number of Dots	800 x 480 DOTS			
Communication	USB Host (Type A) x 2 USB Device (Type B) x 1 USB Device (Type C) x 1 Ethernet (RJ45) x 1 RS232 x 1 Optional Wi-Fi/Bluetooth Dongle			
Leveling System	Motorized Leveling System with Digital Leveling Bubble			
Power Supply	AC Adapter Output: 12 VDC 1.5A			
Weighing Pan Size	Aero Pan 80 x 80 mm			
Build-in Ionizer	Standard Equipped			
Environmental Sensor (Load Cell)	Temperature Sensor, Relative Humidity Sensor (RH), Air Pressure Sensor			
IR Sensor	2 Touchless Sensors on the terminal			
Anti-static glass panel	Standard			
Automatic Draftshield Door Function	Standard, Open Range: 1/2 open and fully open			
Draftshield & Terminal Status Lights	Standard			
Terminal Housing Dimensions (W x D x H)	205mm x 126mm x 66mm			

Base Housing Dimensions (W x D x H)	229mm x 275mm x 78mm
Assembled Dimensions (W x D x H)	229mm x 408mm x 372mm
Shipping Dimensions (W x D x H)	415mm x 630mm x 561mm
Net Weight	7.8 kg
Shipping Weight	12.0 kg

MODEL	EXP124/AD	EXP224/AD	EXP324/AD
	EXP124M/AD	EXP224M/AD	EXP324M/AD
	EXP124N/AD	EXP224N/AD	EXP324N/AD
Capacity (g)	120 g	220 g	320 g
Readability d, full range (mg)	0.1 mg	0.1 mg	0.1 mg
Readability d (EXP...N...model)	0.1 mg (EXP...N...model: 0.1mg or 1mg)		
Repeatability (sd.), ≤5% of full load	0.05 mg	0.05 mg	0.05 mg
Repeatability (sd.), 5% of full load to fine range max	0.1 mg	0.1 mg	0.1 mg
Linearity deviation typical	0.06 mg	0.06 mg	0.06 mg
Linearity deviation	0.2 mg	0.2 mg	0.2 mg
Verification interval, e (EXP...M..models only)	1 mg	1 mg	1 mg
Approval Class (EXP...M.. models only)	Class I	Class I	Class I
Span Calibration Points (g)	25g, 50g, 75g, 100g	50g, 100g, 150g, 200g	100g,150g, 200g, 300g
Weighing units*	18 weighing units: g, mg, ct, N, oz, ozt, Grain, dwt, mo, msg, tl H, tl S, tl T, tcl, tola, baht, Custom 1, Custom 2		
Weighing units* (EXP...M.. models)	g, mg, ct		
Weighing units* (EXP...N. models)	g, mg, ct, oz, ozt, Grain, dwt		
Applications	15 application modes: Basic Weighing, Parts Counting, Check Counting, Percent Weighing, Check Weighing, Dynamic Weighing, Totalization, Formulation, Differential, Density Determination, Peak Hold, Pipette Adjustment, SQC, Fill Weight Variation, Flow Rate Control		
Stabilization time (typical)	2 seconds		
Sensitivity Temperature Drift (ppm/K)	1.5		
Min-Weight (typical) (USP, K=2, U=0.10%)	100 mg		
Min-Weight (optimal) (USP, K=2, U=0.10%, SRP≤0.41d)	82 mg		
Terminal Display	7-inch TFT 16.7M Color Press Screen with Glass Overlay, Detachable Terminal		
Number of Dots	800 x 480 DOTS		
Communication	USB Host (Type A) x 2, USB Device (Type B) x 1, USB Device (Type C) x 1 Ethernet (RJ45) x 1, RS232 x 1; Optional Wi-Fi, Bluetooth Dongle		
Leveling System	Motorized Leveling System with Digital Leveling Bubble		
Power Input	12 VDC, 1.5A		
Power Supply	AC Adapter Input: 100-240 VAC 0.5A 50-60 Hz AC Adapter Output: 12 VDC 1.5A		
Weighing Pan Size	Square Pan 90 x 90 mm		
Build-in Ionizer	Standard Equipped		
Environmental Sensor (Load Cell)	Temperature Sensor, Relative Humidity Sensor (RH), Air Pressure Sensor		
IR Sensor	2 Touchless Sensors on the terminal		
Anti-static glass panel	Standard		
Automatic Draftshield Door Function	Standard , Open Range: 1/2 open and fully open		

Draftshield & Terminal Status Lights	Standard
Terminal Housing Dimensions (W x D x H)	205mm x 126mm x 66mm
Base Housing Dimensions (W x D x H)	229mm x 275mm x 78mm
Assembled Dimensions (W x D x H)	229mm x 408mm x 372mm
Shipping Dimensions (W x D x H)	415mm x 630mm x 561mm
Net Weight	7.8 kg
Shipping Weight	12.0 kg

MODEL	EXP223/AD	EXP423/AD	EXP623/AD	EXP1203/AD
	EXP223M/AD	EXP423M/AD	EXP623M/AD	EXP1203M/AD
	EXP223N/AD	EXP423N/AD	EXP623N/AD	EXP1203N/AD
Capacity (g)	220 g	420 g	620 g	1200 g
Readability d, full range (mg)	1mg	1mg	1mg	1mg
Readability d (mg) (EXP...N...model)	1 mg (EXP...N...model: 1mg or 10mg)			
Repeatability (sd.), ≤5% of full load (mg)	0.7 mg	0.7 mg	0.7 mg	0.7 mg
Repeatability (sd.), 5% of full load to fine range max (mg)	1 mg	1 mg	1 mg	1 mg
Linearity Deviation typical	0.6 mg	0.6 mg	0.6 mg	0.6 mg
Linearity Deviation	2 mg	2 mg	2 mg	2 mg
Verification interval, e (EXP...M models and EXP...N models only)	10 mg	10 mg	10 mg	10 mg
Approval Class (EXP...M.. models and EXP..N..models only)	Class II	Class II	Class II	Class I
Span Calibration Points	50g, 100g, 150g, 200g	100g, 200g, 300g, 400g	300g, 400g, 500g, 600g	400g, 600g, 800g, 1000g
Weighing units*	20 weighing units: g, mg, ct, N, oz, ozt, Grain, dwt, mo, msg, tl H, tl S, tl T, tcl, tola, baht, Custom 1, Custom 2, lb (models with capacity ≥ 620 g), kg (models with capacity ≥ 1200 g)			
Weighing units* (EXP...M.. models and EXP..N..models only)	EXP...M.. models: g, mg, ct, kg (models with capacity ≥ 1200 g) EXP...N.. models: g, mg, ct, oz, ozt, Grain, dwt, lb (models with capacity ≥ 620 g), kg (models with capacity ≥ 1200 g)			
Applications	15 application modes: Basic Weighing, Parts Counting, Check Counting, Percent Weighing, Check Weighing, Dynamic Weighing, Totalization, Formulation, Differential, Density Determination, Peak Hold, Pipette Adjustment, SQC, Fill Weight Variation, Flow Rate Control			
Stabilization time (typical)	≤ 1.5 seconds			
Sensitivity Temperature Drift (ppm/K)	3			
Min-Weight (typical) (USP, K=2, U=0.10%)	1.4 g			
Min-Weight (optimal) (USP, K=2, U=0.10%, SRP≤0.41d)	0.82 g			
Terminal Display	7-inch TFT 16.7M Color Press Screen with Glass Overlay, Detachable Terminal			
Number of Dots	800 x 480 DOTS			
Communication	USB Host (Type A) x 2, USB Device (Type B) x 1, USB Device (Type C) x 1 Ethernet (RJ45) x 1, RS232 x 1; Optional Wi-Fi, Bluetooth Dongle			
Leveling System	Motorized Leveling System with Digital Leveling Bubble			

Power Input	12 VDC, 1.5A
Power Supply	AC Adapter Input: 100-240 VAC 0.5A 50-60 Hz AC Adapter Output: 12 VDC 1.5A
Weighing Pan Size	Square Pan 130 x 130 mm
Build-in Ionizer	Standard
Environmental Sensor (Load Cell)	Temperature Sensor, Relative Humidity Sensor (RH), Air Pressure Sensor
IR Sensor	2 Touchless Sensors on the terminal
Anti-static glass panel	Standard
Automatic Draftshield Door Function	Standard Equipped, Open Range: 1/2 open and fully open
Draftshield & Terminal Status Lights	Standard
Terminal Housing Dimensions (W x D x H)	205mm x 126mm x 66mm
Base Housing Dimensions (W x D x H)	229mm x 275mm x 78mm
Assembled Dimensions (W x D x H)	229mm x 408mm x 372mm
Shipping Dimensions (W x D x H)	415mm x 630mm x 561mm
Net Weight	7.8 kg
Shipping Weight	12.0 kg

MODEL	EXP2202	EXP4202	EXP6202	EXP8202	EXP12202
	EXP2202M	EXP4202M	EXP6202M	EXP8202M	EXP12202M
	EXP2202N	EXP4202N	EXP6202N	EXP8202N	EXP12202N
Capacity (g)	2200 g	4200 g	6200 g	8200 g	12200 g
Readability d, full range (g)	0.01 g	0.01 g	0.01 g	0.01 g	0.01 g
Readability d (g) (EXP...N...model)	0.01g (EXP...N...model: 0.01g or 0.1g)				
Repeatability (sd.), ≤5% of full load (g)	0.007 g	0.007 g	0.007 g	0.007 g	0.007 g
Repeatability (sd.), 5% of full load to fine range max (g)	0.01 g	0.01 g	0.01 g	0.01 g	0.01 g
Linearity Deviation Typical	0.006 g	0.006 g	0.006 g	0.006 g	0.006 g
Linearity Deviation	0.02 g	0.02 g	0.02 g	0.02 g	0.02 g
Verification interval, e (EXP...M.. models and EXP...N..models only)	0.1 g	0.1 g	0.1 g	0.1 g	0.1 g
Approval Class (EXP...M.. models and EXP...N..models only)	Class II	Class II	Class II	Class II	Class I
Span Calibration Points	500g, 1000g, 1500g, 2000g	1000g, 2000g, 3000g, 4000g	2000g, 3000g, 4000g, 6000g	2000g, 4000g, 6000g, 8000g	6000g, 8000g, 10000g, 12000g
Weighing units*	19 weighing units: g, ct, N, oz, ozt, Grain, dwt, mo, msg, tl H, tl S, tl T, tcl, tola, baht, lb, kg Custom 1, Custom 2,				
Weighing units* (EXP...M.. models and EXP...N..models only)	EXP...M.. models: g, ct, kg EXP...N.. models: g, ct, oz, ozt, Grain, dwt, lb, kg				
Applications	15 application modes: Basic Weighing, Parts Counting, Check Counting, Percent Weighing, Check Weighing, Dynamic Weighing, Totalization, Formulation, Differential, Density Determination, Peak Hold, Pipette Adjustment, SQC, Fill Weight Variation, Flow Rate Control				
Stabilization time (typical)	≤ 1 second				
Sensitivity Temperature Drift (ppm/K)	3				
Min-Weight (typical) (USP, K=2, U=0.10%)	14 g				
Min-Weight (optimal) (USP, K=2, U=0.10%, SRP≤0.41d)	8.2 g				
Terminal Display	7-inch TFT 16.7M Color				

	Press Screen with Glass Overlay, Detachable Terminal
Number of Dots	800 x 480 DOTS
Communication	USB Host (Type A) x 2, USB Device (Type B) x 1, USB Device (Type C) x 1 Ethernet (RJ45) x 1, RS232 x 1; Optional Wi-Fi, Bluetooth Dongle
Leveling System	Motorized Leveling System with Digital Leveling Bubble
Power Input	12 VDC, 1.5A
Power Supply	AC Adapter Input: 100-240 VAC 0.5A 50-60 Hz AC Adapter Output: 12 VDC 1.5A
Weighing Pan Size	Trapezoid Pan 178 x 201 mm
Build-in Ionizer	Standard
Environmental Sensor (Load Cell)	Temperature Sensor, Relative Humidity Sensor (RH), Air Pressure Sensor
IR Sensor	2 Touchless Sensors on the terminal
Terminal Status Lights	Standard
Terminal Housing Dimensions (W x D x H)	205mm x 126mm x 66mm
Base Housing Dimensions (W x D x H)	229mm x 275mm x 78mm
Assembled Dimensions (W x D x H)	229mm x 408mm x 97mm
Shipping Dimensions (W x D x H)	385mm x 590mm x 311mm
Net Weight	5.5 kg
Shipping Weight	7.7 kg

MODEL	EXP6201	EXP8201	EXP10201
	EXP6201M*	EXP8201M*	EXP10201M*
Capacity (g)	6200 g	8200 g	10200 g
Readability d, full range (g)	0.1 g	0.1 g	0.1 g
Repeatability (sd.), ≤5% of full load	0.07 g	0.07 g	0.07 g
Repeatability (sd.), 5% of full load to fine range max	0.1 g	0.1 g	0.1 g
Linearity Deviation Typical	0.06 g	0.06 g	0.06 g
Linearity Deviation	0.2 g	0.2 g	0.2 g
Verification interval, e (EXP...M..models only)	0.1 g	0.1 g	0.1 g
Approval Class (EXP...M.. models only)	Class II	Class II	Class I
Span Calibration Points (g)	2000g, 3000g, 4000g, 6000g	2000g, 4000g, 6000g, 8000g	2500g, 5000g, 7500g, 10000g
Weighing units*	19 weighing units: g, ct, N, oz, ozt, Grain, dwt, mo, msg, tl H, tl S, tl T, tcl, tola, baht, lb, kg, Custom 1, Custom 2		
Weighing units* (EXP...M.. models only)	EXP...M.. models: g, ct, kg		
Applications	15 application modes: Basic Weighing, Parts Counting, Check Counting, Percent Weighing, Check Weighing, Dynamic Weighing, Totalization, Formulation, Differential, Density Determination, Peak Hold, Pipette Adjustment, SQC, Fill Weight Variation, Flow Rate Control		
Stabilization time (typical)	≤ 1 second		
Sensitivity Temperature Drift (ppm/K)	5	3	3
Min-Weight (typical) (USP, K=2, U=0.10%)	140 g		
Min-Weight (optimal) (USP, K=2, U=0.10%, SRP≤0.41d)	82 g		
Terminal Display	7-inch TFT 16.7M Color Press Screen with Glass Overlay, Detachable Terminal		
Number of Dots	800 x 480 DOTS		
Communication	USB Host (Type A) x 2, USB Device (Type B) x 1, USB Device (Type C) x 1 Ethernet (RJ45) x 1, RS232 x 1; Optional Wi-Fi, Bluetooth Dongle		
Leveling System	Motorized Leveling System with Digital Leveling Bubble		
Power Input	12 VDC, 1.5A		

Power Supply	AC Adapter Input: 100-240 VAC 0.5A 50-60 Hz AC Adapter Output: 12 VDC 1.5A
Weighing Pan Size	Trapezoid Pan 178 x 201 mm
Environmental Sensor (Load Cell)	Temperature Sensor, Relative Humidity Sensor (RH), Air Pressure Sensor
IR Sensor	2 Touchless Sensors on the terminal
Terminal Status Lights	Standard
Terminal Housing Dimensions (W x D x H)	205mm x 126mm x 66mm
Base Housing Dimensions (W x D x H)	229mm x 275mm x 78mm
Assembled Dimensions (W x D x H)	229mm x 408mm x 97mm
Shipping Dimensions (W x D x H)	385mm x 590mm x 311mm
Net Weight	5.5 kg
Shipping Weight	7.7 kg

MODEL	EXP24001	EXP35001	EXP65001
	EXP24001M*	EXP35001M*	EXP65001M*
	EXP24001N*	EXP35001N*	EXP65001N*
Capacity (g)	24000 g	35000 g	65000 g
Readability d, full range (g)	0.1 g	0.1 g	0.1 g
Readability d (g) (EXP...N...model)	0.1g (EXP...N...model: 0.1g or 1g)		
Repeatability (sd.), ≤5% of full load	0.08 g	0.08 g	0.08 g
Repeatability (sd.), 5% of full load to fine range max	0.1 g	0.1 g	0.1 g
Linearity deviation Typical	0.07 g	0.07 g	0.07 g
Linearity deviation	0.2 g	0.2 g	0.2 g
Verification interval, e (EXP...M models and EXP...N..models only)	1 g	1 g	1 g
Approval Class (EXP...M.. models and EXP..N..models only)	Class II	Class II	Class II
Span Calibration Points (g)	10000g, 15000g, 20000g, 24000g	10000g, 20000g, 30000g, 35000g	20000g, 40000g, 60000g, 65000g
Weighing units*	19 weighing units: g, ct, N, oz, ozt, Grain, dwt, mo, msg, tl H, tl S, tl T, tcl, tola, baht, lb, kg, Custom 1, Custom 2		
Weighing units* (EXP...M.. models and EXP..N..models only)	EXP...M.. models: g, ct, kg EXP...N.. models: g, ct, oz, ozt, Grain, dwt, lb, kg		
Applications	14 application modes: Basic Weighing, Parts Counting, Check Counting, Percent Weighing, Check Weighing, Dynamic Weighing, Totalization, Formulation, Differential, Density Determination, Peak Hold, SQC, Fill Weight Variation, Flow Rate Control		
Stabilization time (typical)	≤ 1 second		
Sensitivity Temperature Drift (ppm/K)	5		
Min-Weight (typical) (USP, K=2, U=0.10%)	160 g		
Min-Weight (optimal) (USP, K=2, U=0.10%, SRP≤0.41d)	82 g		
Terminal Display	7-inch TFT 16.7M Color Press Screen with Glass Overlay, Detachable Terminal		
Number of Dots	800 x 480 DOTS		
Communication	USB Host (Type A) x 2, USB Device (Type B) x 1, USB Device (Type C) x 1 Ethernet (RJ45) x 1, RS232 x 1; Optional Wi-Fi, Bluetooth Dongle		
Leveling System	4 leveling feet with Digital Leveling Bubble		
Power Input	12 VDC, 1.5A		
Power Supply	AC Adapter Input: 100-240 VAC 0.5A 50-60 Hz AC Adapter Output: 12 VDC 1.5A		
Weighing Pan Size	Square Pan 377 mm x 311 mm		

Environmental Sensor (Load Cell)	Temperature Sensor, Relative Humidity Sensor (RH), Air Pressure Sensor
IR Sensor	2 Touchless Sensors on the terminal
Rechargeable Battery	Li-ion, ICR18650, 14.4 V, 2600 mAh
Battery Life	Up to 8 hours with brightness ≤50% Up to 5 hours with brightness ≤90% Full charging time: 6 hours
Terminal Status Lights	Standard
Terminal Housing Dimensions (W x D x H)	205mm x 126mm x 66mm
Base Housing Dimensions (W x D x H)	378mm x 311mm x 125mm
Assembled Dimensions (W x D x H)	378mm x 438mm x 125mm
Shipping Dimensions (W x D x H)	525mm x 665mm x 330mm
Net Weight	11.0 kg
Shipping Weight	13.8 kg

Note 1: M = EC Type approved
 N = NTEP certified and Measurement Canada approved
 C1= Custom Unit 1; C2= Custom Unit 2

Note 2: Default Calibration weights shown in Bold

Note 3: * Availability is dependent on region.

11.3 Accessory Specifications

The LM842 USB Adapter (Dongle)

TECH SPEC



WIRELESS STANDARD	5 ac
BACKWARD COMPATIBILITY	4.2 4.1 4.0 3.0 2.1 b g n
FREQUENCY	24 GHz and 5 GHz
ADAPTER TYPE	Host Controller Interface (HCI)
INTERFACES	USB
ANTENNA	2 x Metal Frame Antennas, SMA Connector
ANTENNA OPTION	1 x Metal Frame Antenna + 1 x SMA Connector
COMPATIBLE ANTENNAS	LM256 2dBi, LM255 1.5dBi, LM251 2dBi
DIMENSIONS	32-37mm x 17.1mm x 94mm
OPERATING TEMPERATURE	-20°C to +85°C
BLUETOOTH TECHNOLOGY	Bluetooth Classic, Bluetooth Low Energy (LE)
COMPATIBILITY	
CERTIFICATIONS	
COMPLIANCE	

11.4 Drawings and Dimensions

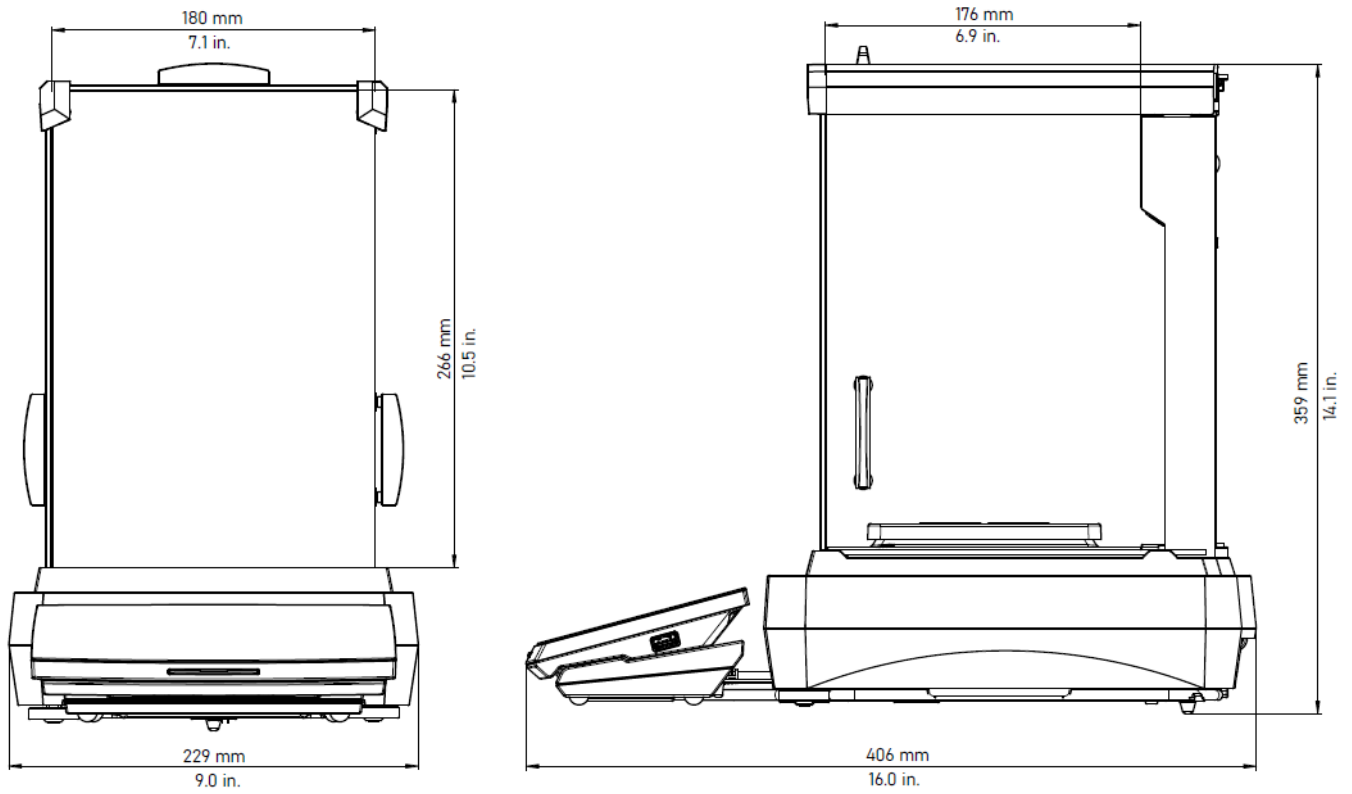

Figure 9-1. Draft Shield models

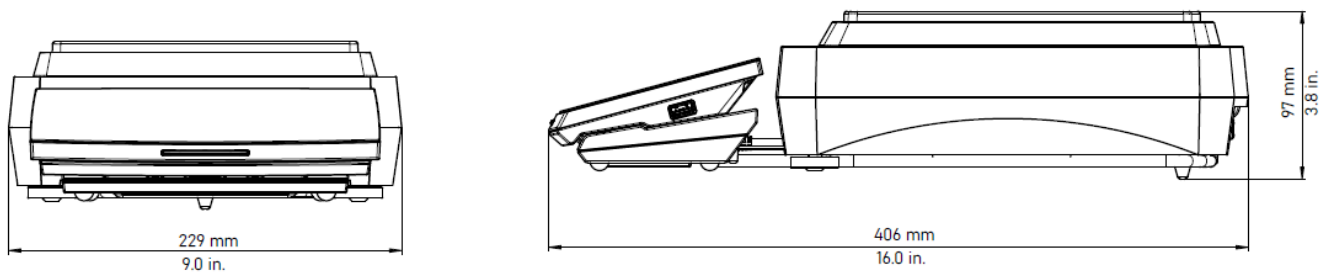

Figure 9-2. Non-Draft Shield models

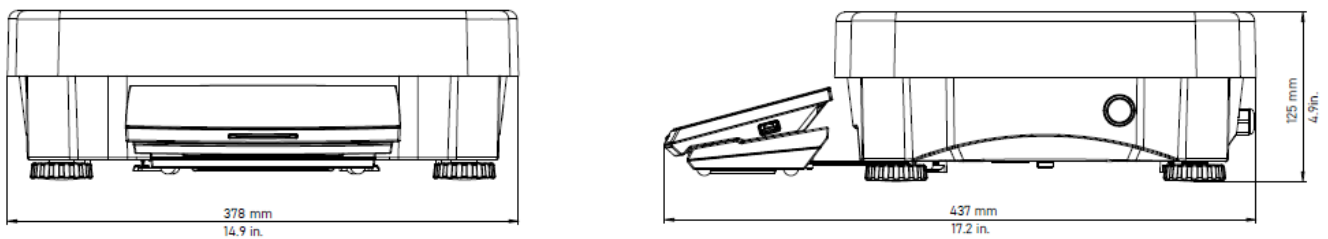

Figure 9-3. EXP24001, EXP35001 and EXP65001 models

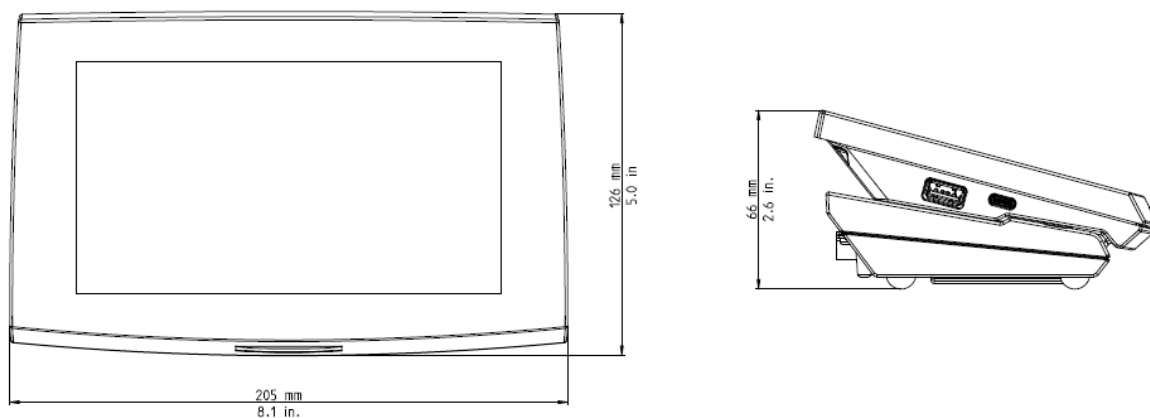











Figure 9-4. Terminal

11.5 Accessories

Image	Description
	<p>Item Number 30095929 (EU) 30130303 (AP) 30130302 (US)</p> <p>Accessory Name Static Ionizer, ION-100A</p>
	<p>Item Number 80253384</p> <p>Accessory Name Density Kit, Solids</p>
	<p>Item Number 83034024</p> <p>Accessory Name Sinkers, Glass, Liquid, Density Kit</p>
	<p>Item Number 31059237</p>

	<p>Accessory Name Weighing Kit</p>
	<p>Item Number 31059238</p> <p>Accessory Name Fingerprint scanner FIN-100A</p>
	<p>Item Number 30252145</p> <p>Accessory Name Pipette Evaporation Trap</p>
	<p>Item Number 31059239</p> <p>Accessory Name BT dongle and Wi-Fi dongle LM842</p>
	<p>Item Number 30064202 (EU) 30045641 (AP) 30064203 (US)</p> <p>Accessory Name Printer, Impact, SF40A</p>
	<p>Item Number 30960983 (EU) 30960982 (AP) 30960984 (US)</p> <p>Accessory Name Bluetooth Printer, Impact, SF40A/BT</p>
	<p>Item Number 12120799</p>

	<p>Accessory Name SF40A Paper roll (57,5mm 2pcs)</p>
	<p>Item Number 30529322</p> <p>Accessory Name SF40A Ink Ribbon Cassette</p>
	<p>Item Number 30808539</p> <p>Accessory Name Tower Kit for EXP High-Capacity Model</p>
	<p>Item Number 31052750</p> <p>Accessory Name Rechargeable Battery for EXP High-Capacity Model</p>
	<p>Item Number 30041470</p> <p>Accessory Name Wheel Kit, Set (4) for EXP High-Capacity Model</p>
	<p>Item Number 30078078</p> <p>Accessory Name Terminal Extension Cable, RS422, 9 m</p>

11.6 Interface Commands

Commands listed in the following table will be acknowledged by the balance.

- Commands sent to the indicator must be terminated by a carriage return-line feed (CRLF).
- Data output is always terminated with a carriage return-line feed (CRLF).
- The balance will return “ES” for invalid commands.

Command	Function
IZ	Trigger Ionizer
AUF	Auto login (Only work when User Management function is off)
LEVEL	Start Leveling
I2	Inquiry of balance data
I3	Inquiry of balance SW version and type definition number
I4	Inquiry of serial number
SIR	Send weight value immediately and repeat
IP	Immediate Print of displayed weight (stable or unstable). IP could be used to stop continuous print and interval print.
P	Print displayed weight according to “ Stable only ” setting in the communication menu. Attention: when APPROVED MODE IS ON, P could only print stable displayed weight.
CP	Continuous Print.
SP_x	Print on Stability. (x: stable time, print if stability is achieved within this time)
P_x	Interval Print x = Print Interval (1-3600 sec) IP/P ends interval Print. Attention: the corresponding settings in the communication menu are modified too.
Z	Same as pressing Zero Key
ZI	Zero Immediately
@	Reboot
T	Same as pressing Tare Key.
TI	Tare Immediately
M_x	Set current application mode to x. x depends on application, use application list.
U_x	Set balance to unit x: g, Kg, lb, oz, etc. . x depends on unit list.
ON	Brings out of Standby
OFF	Goes to Standby.

SIU	Send weight value with currently displayed unit immediately
C3	Begin internal Calibration, same as trigger from calibration menu.
PSN	Print Serial Number.
PV	Print terminal software version, base software version and Approved Mode is set to ON.
#_x _Unit	Set Counting APW (x) in Unit. (must have APW stored, unit can be any unit, g, lb, etc)
%_x _Unit	Set Percent application reference weight (x) in Unit. (must have reference weight stored, unit can be any unit, g, lb, etc)
CO_x _Unit	Set Check weighing Over Limit in x Unit.
CU_x _Unit	Set Check weighing Under Limit in x Unit.
TIM	Print current time.
DAT	Print current date.
TIM_x	Set Time, x format: hh mm ss.
DAT_x	Set Date, x format: mm dd yyyy.
WI 0	Left door open or close.
WI 1	Right door open or close.
WI 2	Both doors open or close.
\EscP	Print weight immediately
\EscT	Tare
\EscU	Tare
\EscV	Zero
\EscW	External calibration
\EscZ	Internal calibration
\Escx1_#_	Print model
\Escx3_#_	Print software version

Note:

There is 40-second timeout control for print under stable requirement. If the unstable condition continues over 40 seconds, balance will back to previous display.

Application list:





ID	application name	Abbreviation
0	Basic weighing	Weighing
1	Parts Counting	Counting
2	Percent weighing	Percent
3	Check weighing	Check
4	Dynamic weighing	Dynamic
6	Totalization	Totalization
7	Formulation	Formulation
8	Differential	Differential
9	Density Determination	Density
10	Peak hold	Peak
12	Pipette adjustment	Pipette
13	SQC	SQC
15	Fill weight variation	Fill
18	Flow Rate Control	
19	Check Counting	

Unit list:

ID	Unit name	Abbreviation
0	Gram	g
1	Kilogram	kg
2	Ton	t
3	Milligram	mg
4	Microgram	ug
5	Carat	ct
6	New ton	N
7	Pound	lb
8	Ounce	oz
9	Ounce (troy)	ozt
10	Grain	GN
11	Penny	dwt
12	Momme	mom
13	Mesghal	msg
14	Tael Hongkong	HKt
15	Tael Singapore	SGt
16	Tael Taiwan	TWt
17	Tical	tcl
18	Tola	tola
19	Baht	baht
20	Pound:Ounces (for U.S. postal / industrial / retail applications)	lb:oz
21	Custom unit 1	C1
22	Custom unit 2	C2

12 COMPLIANCE

Compliance to the following standards is indicated by the corresponding mark on the product.

Mark	Standard
	This product complies with the applicable harmonized standards of EU Directives 2011/65/EU (RoHS), 2014/30/EU (EMC), 2014/35/EU (LVD) and 2014/31/EU (NAWI). The EU Declaration of Conformity is available online at www.ohaus.com/ce .
	This product complies with the EU Directive 2012/19/EU (WEEE). Please dispose of this product in accordance with local regulations at the collecting point specified for electrical and electronic equipment. For disposal instructions in Europe, refer to www.ohaus.com/weee .
	EN 61326-1
	CAN/CSA-C22.2 No. 61010-1 UL 61010-1
LM842 USB Dongle	Compliant to: IEEE 802.11ac, abgn additional standards, Compliant to: Bluetooth® 5.02 and backward compatible with Bluetooth v2.1+EDR / v3.0 / v3.0+HS / v4.0, 4.1, & 4.2 with both BR/EDR. Classic and LE can operate simultaneously. The Realtek IC, RTL8822CU uses a USB main interface. LM842 offers high throughput for both WiFi and Bluetooth® connections, connected via a (HCI) USB 2.0 TYPE A interface The LM842 is certified for United States of America, under FCC and Europe under CE standards.

Important notice for Explorer Plus...M verified weighing instruments in the EU.

When the instrument is used in trade or a legally controlled application it must be set up, verified and sealed in accordance with local weights and measures regulations. It is the responsibility of the purchaser to ensure that all pertinent legal requirements are met.

Weighing Instruments verified at the place of manufacture must bear one of the following supplementary metrologies marking on the descriptive plate.



Weighing Instruments to be verified in two stages have no supplementary metrology marking on the descriptive plate. The second stage of conformity assessment must be carried out by the applicable weights and measures authorities.

If national regulations limit the validity period of the verification, the user of the weighing instrument must strictly observe the re-verification period and inform the weights and measures authorities.

As verification requirements vary by jurisdiction, the purchaser should contact their local weights and measures office if they are not familiar with the requirements.

Industry Canada Note

CAN ICES-003(A) / NMB-003(A)

ISO 9001 Registration

The management system governing the production of this product is ISO 9001 certified.

Notes:

All the icons used for terminal design are sourced from a free platform: (<https://icons8.com/icons>).

Note: All the sound used for volume design are sourced from a free platform: (<https://pixabay.com/sound-effects>).

FCC Supplier Declaration of Conformity

Unintentional Radiator per 47CFR Part B

Trade Name: OHAUS CORPORATION

Model: Explorer Plus™ EXP...

Party issuing Supplier's Declaration of Conformity:

Ohaus Instruments (Changzhou) Co., Ltd.

Building C, No. 6 Zhengqiang Road, Xuejia Town, Xinbei District, Changzhou

Jiangsu 213022,

China

Phone: +86 519 85287270

Responsible Party – U.S. Contact Information:

Ohaus Corporation

8 Campus Drive, Suite 105

Parsippany, NJ 07054

United States

Phone: +1 973 377 9000

Web: www.ohaus.com

FCC Compliance Statement:

Note: This equipment has been tested and found to comply with the limits for a Class A digital device, pursuant to part 15 of the FCC Rules. These limits are designed to provide reasonable protection against harmful interference when the equipment is operated in a commercial environment. This equipment generates, uses, and can radiate radio frequency energy and, if not installed and used in accordance with the instruction manual, may cause harmful interference to radio communications. Operation of this equipment in a residential area is likely to cause harmful interference in which case the user will be required to correct the interference at his own expense. Changes or modifications not expressly approved by the party responsible for compliance could void the user's authority to operate the equipment.

13 LIMITED WARRANTY

Ohaus products are warranted against defects in materials and workmanship from the date of delivery through the duration of the warranty period. During the warranty period Ohaus will repair, or, at its option, replace any component(s) that proves to be defective at no charge, provided that the product is returned, freight prepaid, to Ohaus.

This warranty does not apply if the product has been damaged by accident or misuse, exposed to radioactive or corrosive materials, has foreign material penetrating to the inside of the product, or because of service or modification by other than Ohaus. In lieu of a properly returned warranty registration card, the warranty period shall begin on the date of shipment to the authorized dealer. No other express or implied warranty is given by Ohaus Corporation. Ohaus Corporation shall not be liable for any consequential damages.

As warranty legislation differs from state to state and country to country, please contact Ohaus or your local Ohaus dealer for further details.