

350-ADA-1

*Dual-ramp ADA Compliant Wheelchair Scale
Software Version 11525*

Operation Manual



© Rice Lake Weighing Systems. All rights reserved.

Rice Lake Weighing Systems® is a registered trademark of
Rice Lake Weighing Systems.

All other brand or product names within this publication are trademarks or
registered trademarks of their respective companies.

All information contained within this publication is, to the best of our knowledge, complete and
accurate at the time of publication. Rice Lake Weighing Systems reserves the right to make
changes to the technology, features, specifications and design of the equipment without notice.

Revision History

This section tracks and describes the current and previous manual revisions for awareness of major updates and when the updates took place.

Revision	Date	Description
A	December 4, 2025	Initial manual release with product; software version 11525
B	February 10, 2026	Updated platform dimensions

Table i. Revision Letter History

Contents

1.0 Introduction	5
1.1 Safety	5
1.2 FCC Compliance	6
1.3 Disposal	6
2.0 Assembly	7
2.1 Unpacking	7
2.1.1 Repacking	11
2.2 Scale Setup	11
2.2.1 Attaching Feet to the Scale	11
2.2.2 Installing Ramps onto the Scale	12
2.2.3 Leveling the Scale Base	12
2.2.4 Hinge Setup	13
2.2.5 Insert Alkaline Batteries	14
2.2.6 Power Connection	14
3.0 Operation	15
3.1 Key Descriptions	15
3.2 Weighing	16
3.3 Hold/Release Function	16
3.4 Preset Tare	16
3.5 Toggle Tare	16
3.6 Using the Body Mass Index (BMI) Function	17
3.6.1 LB Mode	17
3.6.2 KG Mode	17
3.7 Troubleshooting	18
4.0 RS-232 Communication	19
4.1 Push-button Keypad Print	19
4.2 USB Connection	20
5.0 Maintenance	21
5.1 Basic Maintenance	21
5.2 Cleaning	21
5.3 Periodic Maintenance	21
6.0 Specifications	22

1.0 Introduction

The 350-ADA-1 dual-ramp digital wheelchair scale is a user-friendly and ADA compliant quality scale, designed for safe weighing of ambulatory and non-ambulatory patients. Movement compensation technology ensures sound, accurate weighments.

The scale is set up to use motion sensing technology, to determine actual weight of a moving patient. The weight can be displayed in pounds or kilograms. To obtain a tare weight, See [Section 3.0 on page 15](#).

The wheelchair scale has a unique folding feature that enables easy transportation and simplifies assembly, avoiding the need for field wiring and recalibration.



Manuals are available from Rice Lake Weighing Systems at www.ricelake.com/manuals

Warranty information is available at www.ricelake.com/warranties

1.1 Safety

Safety Definitions:



DANGER: Indicates an imminently hazardous situation that, if not avoided, will result in death or serious injury. Includes hazards that are exposed when guards are removed.



WARNING: Indicates a potentially hazardous situation that, if not avoided, could result in serious injury or death. Includes hazards that are exposed when guards are removed.



CAUTION: Indicates a potentially hazardous situation that, if not avoided, could result in minor or moderate injury.



IMPORTANT: Indicates information about procedures that, if not observed, could result in damage to equipment or corruption to and loss of data.

General Safety



Do not operate or work on this equipment unless this manual has been read and all instructions are understood. Failure to follow the instructions or heed the warnings could result in injury or death. Contact any Rice Lake Weighing Systems dealer for replacement manuals.



WARNING

Failure to heed could result in serious injury or death.

Ensure every individual who operates or works with this unit has read and understands all safety information.

Do not transport the scale while someone is on the scale.

Do not allow minors (children) or inexperienced persons to operate this scale.

Do not use in the presence of flammable materials.

Do not use this product if any of the components are loose or cracked.

Do not use near water.

Do not use the scale on slippery surfaces, such as a wet floor.

Do not use this scale when a person's body or feet are wet, such as after taking a bath.

Do not place fingers into slots or possible pinch points.

To avoid cross contamination, the scale should be cleaned regularly.

Prior to cleaning, make sure the scale is disconnected from the power source.

People with disabilities, or who are physically fragile, should always be assisted by another person when using this scale.



IMPORTANT

Do not drop the scale or subject it to violent shocks.

Do not jump on the scale.

For accurate weighing, the scale must be placed on a flat, stable surface.

Operating at voltages and frequencies other than specified could damage the equipment.

Avoid contact with excessive moisture.

Do not make alterations or modifications to the scale.

Rice Lake Weighing Systems offers optional AC adapters; utilizing an adapter not supplied by Rice Lake Weighing Systems voids all warranties and approvals.

Weight exceeding the maximum capacity may damage the scale.

1.2 FCC Compliance

United States

This equipment has been tested and found to comply with the limits for a Class A digital device, pursuant to Part 15 of the FCC Rules. These limits are designed to provide reasonable protection against harmful interference when the equipment is operated in a commercial environment. This equipment generates, uses, and can radiate radio frequency energy and, if not installed and used in accordance with the instruction manual, may cause harmful interference to radio communications. Operation of this equipment in a residential area is likely to cause harmful interference in which case the user will be required to correct the interference at his own expense.

Canada

This digital apparatus does not exceed the Class A limits for radio noise emissions from digital apparatus set out in the Radio Interference Regulations of the Canadian Department of Communications.

Le présent appareil numérique n'émet pas de bruits radioélectriques dépassant les limites applicables aux appareils numériques de la Class A prescrites dans le Règlement sur le brouillage radioélectrique édicté par le ministère des Communications du Canada.

1.3 Disposal



Product Disposal

The product must be brought to appropriate separate waste collection centers at the end of its life cycle.

Proper separate collection to recycle the product helps prevent possible negative effects on the environment and to health, and promotes the recycling of the materials. Users who dispose of the product illegally shall face administrative sanctions as provided by law.

Battery Disposal

Dispose of batteries at appropriate waste collection centers at the end of their life cycle in accordance with local laws and regulations. Batteries and rechargeable batteries may contain harmful substances that should not be disposed of in household waste. Batteries may contain harmful substances including but not limited to: cadmium (Cd), lithium (Li), mercury (Hg) or lead (Pb). Users who dispose of batteries illegally shall face administrative sanctions as provided by law.



WARNING: Risk of fire and explosion. Do not burn, crush, disassemble or short-circuit lithium batteries.

2.0 Assembly

Use the following information to unpack and set up the 350-ADA-1 digital wheelchair scale.

2.1 Unpacking

The following procedure describes how to unpack the scale and scale components from the shipping crate.

1. Place the unopened crate in an open area that has ample room for unpacking the scale.



NOTE: Due to its size, at least two people are recommended for unpacking the scale.

2. Use a Phillips drill bit to remove the ten screws securing the shipping crate cover (see [Figure 2-1](#)).



Screw locations
marked with blue
paint

Figure 2-1. Crate Cover Screw Removal

3. Remove and set aside the crate cover.
4. Remove the two cardboard blocks.

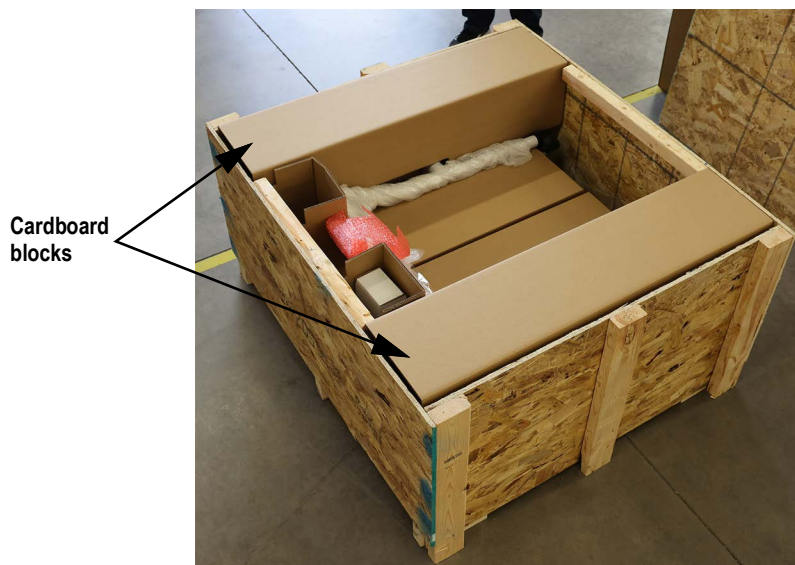

Figure 2-2. Opened Shipping Crate

5. Remove the six screws securing the side panel to the crate.



Figure 2-3. Side Panel Screw Removal

6. Remove and set aside the side panel.
7. Repeat [Step 5](#) and [Step 6](#) for the second side panel.
8. Locate and set aside the parts box and manual.

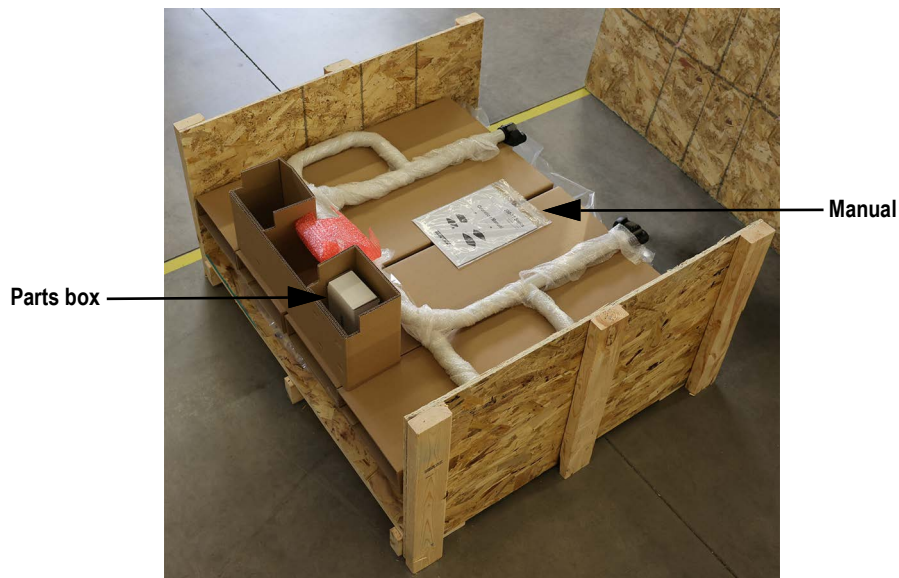

Figure 2-4. Crate with Side Panels Removed

9. Loosen the clamps to raise the handrail (see [Figure 2-5](#)).
10. Remove the four cardboard platforms.



Figure 2-5. Raising Handrail and Removing Cardboard Platforms

11. Lift and remove the scale ramps from the crate.



Figure 2-6. Unpacking Scale Ramp

12. Remove the remaining cardboard pieces.



NOTE: For ease of removal, fold the handrail back down before moving the scale.

13. With assistance, lift and remove the scale base from the crate and gently set it down on the floor (see [Figure 2-7](#)).



CAUTION: Rice Lake Weighing Systems recommends using two people for lifting the scale and to use proper lifting techniques to prevent injury.



IMPORTANT: Do not lift the scale out of the crate by its handrail as this can cause the hinges to break or affect the scale operation.



Figure 2-7. Unpacking Scale



NOTE: Visually inspect the scale to ensure all parts are included and undamaged. If parts were damaged in shipment, notify Rice Lake Weighing Systems and the shipper immediately.

Parts contained in the shipping crate include:

- * Scale
- * Manual
- * AA batteries (6) (see “Parts Inside” box in [Figure 2-8 on page 10](#))
- * Scale feet (4) (see “Parts Inside” box in [Figure 2-8 on page 10](#))
- * Scale ramps (2)
- * 5 mm Allen wrench (see “Parts Inside” box in [Figure 2-8 on page 10](#))
- * Allen bolt (10) (see “Parts Inside” box in [Figure 2-8 on page 10](#))



Figure 2-8. Parts Box

2.1.1 Repacking

Retain the packaging for use in the event that the scale must be returned or moved. The product must be properly packed with sufficient packing materials. Whenever possible, use the original carton and packing materials when shipping the scale back.



IMPORTANT: *Damage caused by improper packaging is not covered by the warranty.*

2.2 Scale Setup

Move the scale into the area where the weighing process will occur. Place the scale on a hard, level surface for the most accurate weighments. Placing the scale on thin carpeting is not recommended.

2.2.1 Attaching Feet to the Scale

The 350-ADA-1 digital wheelchair scale comes with four feet that must be attached to the scale base for proper operation. The four feet are located in the parts box in the original shipping crate. Use the following steps to attach the feet to the scale.

1. Tip the scale onto it's side on a level surface so the scale base is accessible.
2. Remove the plastic packaging from the scale base.



Figure 2-9. Tipped Scale



CAUTION: *When tipping the scale, be cautious of surroundings to prevent potential injuries.*



IMPORTANT: *To avoid damaging the threading, ensure the feet are correctly aligned during installation.*

3. Rotate the four round feet clockwise into the scale base until finger-tight as shown in [Figure 2-10](#).

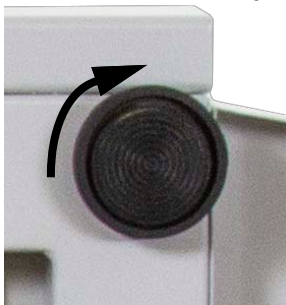

Figure 2-10. Secure Scale Platform Feet

2.2.2 Installing Ramps onto the Scale

1. Hold the ramp vertically against the end of the scale (see Figure 2-11).
2. Starting from the top, thread each of the five screws through the ramp into the scale without fully tightening.

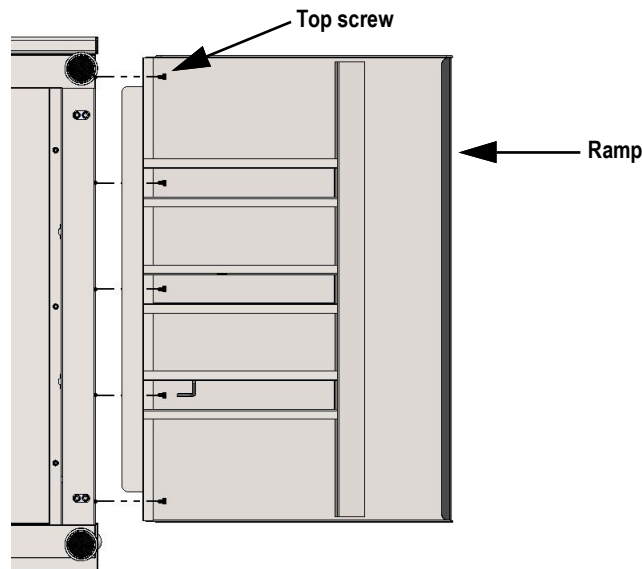

Figure 2-11. Attaching Ramp to Scale

3. Once all screws are threaded, tighten each screw with the 5 mm Allen wrench provided.

IMPORTANT: To avoid damaging the threading, ensure all screws are properly aligned before tightening.

4. Repeat Step 1 to Step 3 for the second ramp.

2.2.3 Leveling the Scale Base

CAUTION: Lowering the scale should be accomplished by two people. Do not lower the scale by the handrails. Instead, lower the scale by the scale base.

1. With assistance, gently set the scale base down on to the floor. Ensure there is minimal clearance between the scale base and the floor without having the scale base contacting the floor.



Figure 2-12. Scale Base Clearance

2. It is important to ensure that the scale is completely level. Gently press down on all corners of the scale base to ensure that there are no high spots or rocking of the scale base.
3. Adjust feet as needed to level the scale.

NOTE: An uneven base will produce inaccurate weight readings.

2.2.4 Hinge Setup

1. Remove the bubble wrapping from the handrail and indicator.
2. Loosen the knobs by rotating counterclockwise and set the scale arms upright.



Figure 2-13. Loosen the Durable Hinges to Set Handles Upright

3. Tighten the two hinges on the 350-ADA-1 digital wheelchair scale by tightening the two knobs by rotating clockwise to secure the handrail mounted indicator.

2.2.5 Insert Alkaline Batteries

The six AA batteries supplied with the scale provide an average of 25 hours of continuous use.

To install the batteries:

1. Turn thumbscrew counterclockwise then remove battery cover.
2. Insert batteries into the battery chamber as illustrated.



Figure 2-14. Battery Chamber

3. Put the cover in place and turn the thumbscrew clockwise to secure.



NOTE: Remove the batteries prior to storing if the product is not going to be used for an extended period of time.



NOTE: If the LO BAT indicator activates, for accurate weighing, replace the batteries or connect the scale to an AC power source as soon as possible.

2.2.6 Power Connection

An optional AC power adapter can be used when a power outlet is available.



IMPORTANT: Only use power adapters supplied by or purchased from Rice Lake Weighing Systems. The use of a power adapter not from Rice Lake Weighing Systems voids the warranty.



Figure 2-15. Power Connection Site



NOTE: The battery annunciator on the display turns off when using an AC power connection. The brightness of the backlight is reduced to 60% when using battery power.

3.0 Operation

This section describes the front panel and includes procedures for operation of the scale.



Figure 3-1. Front Panel Keypad

3.1 Key Descriptions

The display has 10 front panel keys. Key functions are described in the table below.

IMPORTANT: The front panel keys are very sensitive, so only a gentle press is required.













Key	Name	Function
 On/Off	On/Off	Powers the scale on or off
 Print LB/KG	Print LB/KG	Sends data out from the RS-232 port; Allows to toggle between kilograms and pounds providing that it is enabled in Configuration mode; Cannot toggle while in the BMI mode
 Zero	Zero	Only functions if the current weight is stable and less than 2% of the capacity of the scale. Anything over 2% requires a recalibration
 Hold Release	Hold Release	Displays most current weight value on the display and holds that value when the patient is off the scale. A second press releases the weight value. Not active while in BMI mode
 BMI	BMI	Pressing the BMI key enables access to the BMI (Body Mass Index) mode (defaults when scale is turned on). The patient is gets on the scale, weight stabilizes and press the BMI key. The display then asks for the patient height to calculate out the patient BMI.
 TARE	TARE	Used to remove the weight initially of anything on the scale that shouldn't be included in the total weight of the patient on the scale
 CLEAR	CLEAR	When using the BMI function, the display looks for a height entry. Pressing Clear changes this entry back to 190.0 cm (default) or 5 ft, 7.5 in. Once BMI is displayed, pressing the Clear key exits BMI
 ENTER	ENTER	Used to accept height in BMI mode; accepts the value of the parameter last entered and moves to the next stage. Pressing and holding Enter during startup will display ID. This is the first setup on entering into configuration mode
 Up Arrows	Up Arrows	Adjusts the value of the flashing digit/number Adjusts height input (0.5 in/0.5 cm) while in BMI mode
 Down Arrows	Down Arrows	Adjusts the value of the flashing digit/number Adjusts height input (0.5 in/0.5 cm) while in BMI mode

Table 3-1. Key Functions



3.2 Weighing

Use the following steps to weigh.

1. Press  to turn on the scale. **0.0** appears on the display along with the **ZERO** annunciator.
2. Place the patient on the scale. The patient's weight is displayed, the **LOCK** annunciator is on and the indicator beeps to indicate the end of the weighing process.
3. Press  to change the display from lb to kg and vice-versa.
4. Press and hold  until **OFF** displays to turn off the scale.

3.3 Hold/Release Function

Use the following steps to use the Hold/Release function.

1. Press  to turn on the scale. **0.0** prompts along with **ZERO** on the display.
2. Press  once the patient's weight stabilizes. The patient's weight and the **HOLD** and **LOCK** annunciators remain on the display when the patient is off the scale.
3. Press  again to return the scale to zero.





NOTE: Pressing  will not work while using Hold/Release function.



NOTE: Pressing  prior to the patient getting on the scale will also hold the weight display.

3.4 Preset Tare

Use the following steps for the Preset Tare function prior to patient weighing if additional items are being used by the patient.

1. Press  to turn on the scale. **0.0** appears on the display along with the **ZERO** annunciator.
2. Place additional item(s) on the scale.
3. Press  until the display returns to **0.0** and **NET** annunciator appears on the display.
4. Remove additional item(s) from the scale. The weight displays with a negative symbol to the left of it.



NOTE: Not removing the additional item(s) prior to patient weighing will also work.





5. Position the patient and additional item(s) on the scale. The display identifies the patient weight. The **NET** annunciator is still active. The weight of the additional item(s) remains stored in memory for the duration of this weigh in.
6. To cancel the tare weight, remove patient from the scale and press  until **NET** disappears from the display and the display turns back to **0.0** and **GROSS** appears.



NOTE: Tare weight is also canceled when the scale is turned off.

3.5 Toggle Tare





Use the following steps to use the Toggle Tare function when the additional item to be weighed is known.

1. Press  when the scale is empty and **0.0** displays. The default values prompts while **0.0** is flashing on the display (default is programmed to be 33.0 lb/15.0 kg).
2. Use  and  to adjust the value. Press  to start the tare function. The **NET** annunciator turns on instead of the **GROSS** annunciator.





3.6 Using the Body Mass Index (BMI) Function

Use the following steps in determining the BMI.

3.6.1 LB Mode

1. Ensure that the scale is at zero.
2. Place the patient on the scale to obtain a weight. The **LOCK** annunciator appears on the display.
3. Press . The **BMI** and **FT/IN** annunciators appear on the display and a default height value of 5 feet - 7.5 inch (5 - 07.5) is flashing.
4. Use  and  to adjust the height value.
5. Press .
6. The BMI value and **BMI** annunciator are shown on the display. Press  to return to the **Weighing** mode and the BMI function will be turned off.

3.6.2 KG Mode

1. Ensure that the scale is at zero.
2. Place the patient on the scale to obtain a weight. The **LOCK** annunciator appears on the display.
3. Press . The **BMI** and **CM** annunciators appear on the display and a default height value of 170.0 cm (170.0) is flashing.
4. Use  and  to adjust the height value.
5. Press .
6. The BMI value and **BMI** annunciator are shown on the display. Press  to return to the **Weighing** mode and the BMI function will be turned off.

3.7 Troubleshooting

Refer to the following table to check and correct any failure before contacting service personnel.

Symptom	Possible Cause	Corrective Action
Scale does not turn on	Dead batteries	Replace batteries or connect to AC power
	Faulty electrical outlet	Use a different electrical outlet
	Bad power supply	Replace adapter
Questionable weight or the scale does not zero	External object is interfering with the scale	Remove the interfering object from the scale
	Display did not show 0.0 before weighing	Help the patient off the scale, zero the scale and begin the weighing process again
	Scale is not placed on a level floor	Ensure scale is level and begin the weighing process again
	Scale is out of calibration	Check the weight with a certified calibration weight
	Scale base is touching floor during a weighment	Adjust height of feet so fingers can slide between the base of scale and the floor all the way around the platform
The display shows a STOP message	The load on the scale exceeds the capacity of the scale	Remove the excess weight and use the scale according to manufacture specifications
The display shows LO Bat message	The battery is low	Replace batteries
The display shows E and Err messages as detailed below		
E06	Identifier - ADC	AD too high
E07		AD too low
E10	Overload	Scale has been overloaded. Remove load from scale
E4L	BAT	Battery low, but still usable- one bar left on indicator display
E4U		Battery low and unstable - no bars left on indicator display
E11	CAL	Calibration Error - recalibrate scale
Err 1	Load cell cable may be plugged into wrong connection port	Ensure cable is connected to the load cell connection port. Note: Load cell connection point is located underneath the curved plastic cover of the indicator. Remove four back retaining screws, remove curved back cover to access load cell connection point.
Err 2	Low saturation state (low A/D)	The load cell is not connected properly; Check the cables and mechanical connections; if the problem persists, replace the set of load cells
Err 3	High saturation state (high A/D)	See Err 2
Err 6	Unstable weight; Cannot calibrate	Check the load cell mechanical surroundings and ensure nothing is contacting the load cell and that the cables are properly welded
Err 7	Scale isn't moving	Make sure feet are installed on the scale. Turn the feet all the way in and then back them out three full turns, then level the scale
SAT	Damaged load cell cable	Replace load cell cable
	Load cell cable may be plugged into wrong connection port	Ensure cable is connected to the load cell connection port. Note: Load cell connection point is located underneath the curved plastic cover of the indicator. Remove four back retaining screws, remove curved back cover to access load cell connection point.

Table 3-2. Troubleshooting Table

4.0 RS-232 Communication

The unit comes with an RS-232 port that enables weight data to be transmitted to other equipment, such as a computer or printer. The RS-232 cable with DB-9 connector (PN 100719) is available from Rice Lake Weighing Systems. That connection is shown in USB Connection section on the next page.

The RS-232 parameters are:

- 9600 baud (selectable in the programming mode)
- 8 data bits
- 1 stop bit
- no parity
- no handshaking

There are three methods of communication:

- Push-button keypad print
- Standard remote protocol
- Escape protocol

4.1 Push-button Keypad Print

With a stable, in-range weight, press and hold  for at least three seconds, or until the scale emits two quick beeps.



NOTE: If the scale does not beep after five seconds, release  as the weight was either in motion or out of range.

If displaying weight and not BMI, the scale will send out the following 21 character string:

```
xxxxxxxx<SP>uu<SP>mmmmm<SP><CR><LF>
```

Token	Description
xxxxxxxx	Weight with decimal point and “-” sign
<SP>	Space
uu	Unit - lb or kg
mmmmm	Mode - gross or net
<CR>	Carriage return
<LF>	Line feed (moves cursor down to the next line)

Table 4-1. Print Format Tokens

Example:

```
-10 Lb net = <SP><SP><SP><SP>-10.0<SP>lb<SP><SP>Net<SP><SP><SP><CR><LF>
```

```
10 Lb gross = <SP><SP><SP><SP><SP>10.0<SP>lb<SP>Gross<SP><CR><LF>
```

- The scale will send out the following data while in **BMI** mode (displaying the BMI value):

Setting	Value
Gross Weight	215 Lb
Tare Weight	0.0 Lb
Net Weight	215 Lb
Patient Height	6-01.0 ft
Patient BMI	28.4

Table 4-2. BMI Data

4.2 USB Connection

The scale has the capability of connecting to a Windows® computer (PC) using a USB cable (not included) and a terminal emulation program. A terminal emulation program allows the transfer of data between the scale and PC using a serial port.



Figure 4-1. Connection Ports



NOTE: Apple® and Macintosh® computers are unable to transfer the necessary data to the scale. Only use a PC for data transfer.

Connecting software and downloads should always be addressed by the IT department for safety reasons and can vary depending on what type of computer platform is being used.



NOTE: Consult the IT department if driver protections are preventing the use of the USB driver. Driver protections may need to be temporarily disabled on Windows 10 or later computers to allow for the installation of the USB driver.

1. Connect the scale's indicator to a PC using a USB-Type B to USB-Type A cable (not included).
2. Turn the indicator on.



NOTE: In most cases, the PC should find the driver and automatically configure the driver when the scale is plugged into a USB port.

3. Open a terminal emulation program, such as Advanced Serial Port Terminal, pUttY or Hercules (used in this example).
4. Connect to the serial port assigned by the PC (COM5 in example). This can be found in Device Manager. Once selected, press **Open**.

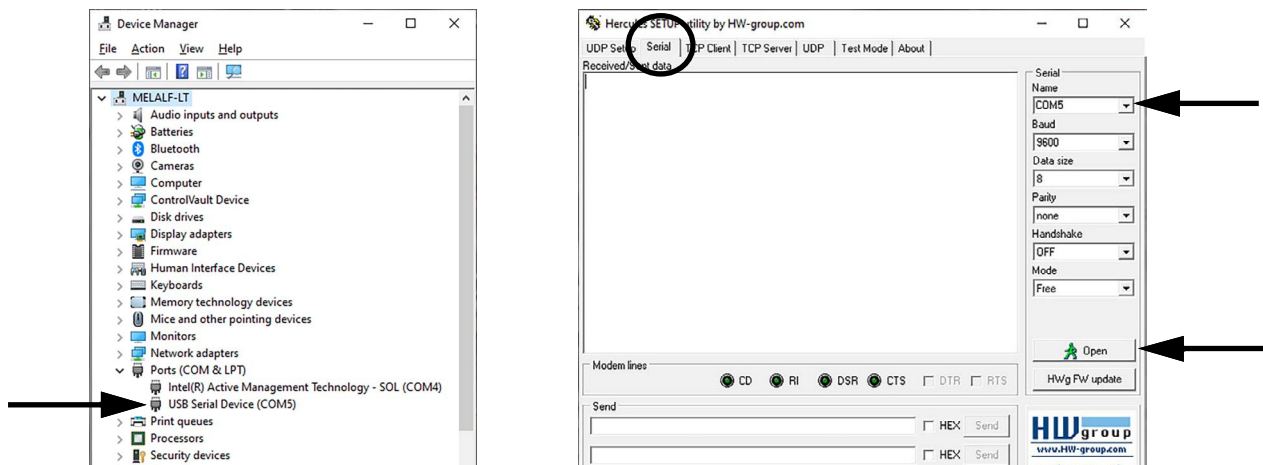

Figure 4-2. Connecting to a Serial Port

5. With weight on the scale, press and hold the **Print** button on the indicator for three seconds. The patient's weight is sent to the PC.

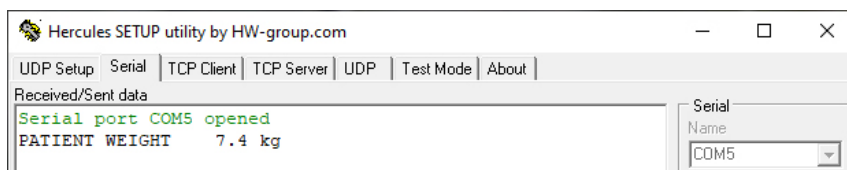

Figure 4-3. Patient Weight Displayed

5.0 Maintenance

The following section provides instructions for maintaining and cleaning the unit.



IMPORTANT: Do not immerse the scale in cleaning or other liquid solutions.

Do not use Isopropyl alcohol or other solutions to clean the indicator display surface.

5.1 Basic Maintenance

Before the first use of the scale and after periods of non-use, check the scale for proper operation and function. If the scale does not operate correctly, contact a qualified service personnel.

Go through the following steps for basic maintenance.

- Check the overall appearance of the entire scale for any obvious signs of damage
- Inspect the condition of the AC power adapter cord for cracking, fraying or for broken or bent prongs

5.2 Cleaning

Proper care and cleaning is essential to ensure a long life of accurate and effective operation. Before beginning the cleaning process, disconnect the scale from the AC power source.

- Clean all external surfaces with a clean, damp cloth or tissue. Mild soap and water solution may be used. Dry with a clean soft cloth
- Do not immerse the scale into cleaning or other liquid solutions
- Do not use Isopropyl alcohol or other solutions to clean the display surface

5.3 Periodic Maintenance

Refer to the following table for periodic maintenance guidelines:

Task	Process	Daily/Weekly	Quarterly	Per Local Regulations
Routine Cleaning	Remove dirt, dust and debris	X		
Ensure scale is level	Check level and adjust scale feet as needed	X		
Test repeatability and accuracy	Place a minimum of 5% of full scale capacity on the scale 3 times in each quadrant		X	
Inspect for damage	Check AC power adapter, hinges, etc for visible damage or missing parts		X	
Calibrate	Perform certified calibration			X
Certification	Review and renew test weight certifications			X

Table 5-1. Periodic Maintenance

6.0 Specifications

Power

120 VAC - 9 VDC - 60Hz / 230 VAC - 9 VDC - 50Hz

Battery Type

6 AA size Alkaline batteries

Battery Use

25 hours continuous use

Automatic power-off can be configured

Data Communications

RS-232 with RJ-45 jack

USB Connection

Selectable baud rate, default - 9600

8 bits

No parity

1 stop bit

No handshaking

Environmental

Operating Temperature 50°F to 104°F (10°C to 40°C)

Storage Temperature 32°F to 122°F (0°C to 50°C)

Humidity 85% relative humidity

Capacity and Graduation

1000 lb x 0.2 lb (453 kg x 0.1 kg)

Dimensions

Platform Dimensions 40.60 in L x 32.00 in W x 4.50 in H

Platform Dimensions (incl. Handrail) 40.60 in L x 32.00 in W x 35.90 in H