

# 260-10-1

---

*Bariatric Handrail Scale  
Software Version 11525*

# Operation Manual



© Rice Lake Weighing Systems. All rights reserved.

Rice Lake Weighing Systems® is a registered trademark of  
Rice Lake Weighing Systems.

All other brand or product names within this publication are trademarks or  
registered trademarks of their respective companies.

All information contained within this publication is, to the best of our knowledge, complete and  
accurate at the time of publication. Rice Lake Weighing Systems reserves the right to make  
changes to the technology, features, specifications and design of the equipment without notice.

# Revision History

---

This section tracks and describes the current and previous manual revisions for awareness of major updates and when the updates took place.

Revision	Date	Description
A	August 17, 2022	Established a revision history; formatted content to match other medical manuals; software version 11525
B	November 20, 2024	Revised battery replacement instructions
C	September 3, 2025	Updated indicator photos; updated maintenance section

*Table i. Revision Letter History*

# Contents

---

<b>1.0 Introduction</b>	<b>5</b>
1.1 Safety	5
1.2 FCC Compliance	6
1.3 Disposal	6
<b>2.0 Assembly</b>	<b>7</b>
2.1 Unpacking	7
2.1.1 Repackaging	7
2.2 Scale Setup	7
2.3 Battery	11
2.3.1 Insert Alkaline Batteries	11
2.3.2 Power Connection	11
<b>3.0 Operation</b>	<b>12</b>
3.1 Key Descriptions	12
3.2 Weighing	13
3.3 Hold/Release Function	13
3.4 Preset Tare	13
3.5 Toggle Tare	13
3.6 Using the Body Mass Index (BMI) Function	14
3.6.1 LB Mode	14
3.6.2 KG Mode	14
3.7 Troubleshooting	15
<b>4.0 Communication</b>	<b>16</b>
4.1 Push-button Keypad Print	16
4.2 USB Connection	17
<b>5.0 Maintenance</b>	<b>18</b>
5.1 Basic Maintenance	18
5.2 Cleaning	18
5.3 Periodic Maintenance	18
<b>6.0 Optional Accessories</b>	<b>19</b>
6.1 Height Rod (PN 172958)	19
6.1.1 Unpacking the Height Rod	19
6.1.2 Assembling the Height Rod	19
6.1.3 Using the Height Rod	20
<b>7.0 Specifications</b>	<b>21</b>

# 1.0 Introduction

The 260-10-1 bariatric handrail scale is efficiently designed to provide accurate, reliable and repeatable weight measurements. A non-skid platform paired with side rails assists individuals needing extra support for safety reasons. The weight is displayed on the indicator in pounds or kilograms.



Manuals are available from Rice Lake Weighing Systems at [www.ricelake.com/manuals](http://www.ricelake.com/manuals)

Warranty information is available at [www.ricelake.com/warranties](http://www.ricelake.com/warranties)

## 1.1 Safety

### Safety Definitions:



**DANGER:** Indicates an imminently hazardous situation that, if not avoided, will result in death or serious injury. Includes hazards that are exposed when guards are removed.



**WARNING:** Indicates a potentially hazardous situation that, if not avoided, could result in serious injury or death. Includes hazards that are exposed when guards are removed.



**CAUTION:** Indicates a potentially hazardous situation that, if not avoided, could result in minor or moderate injury.



**IMPORTANT:** Indicates information about procedures that, if not observed, could result in damage to equipment or corruption to and loss of data.

### General Safety



Do not operate or work on this equipment unless this manual has been read and all instructions are understood. Failure to follow the instructions or heed the warnings could result in injury or death. Contact any Rice Lake Weighing Systems dealer for replacement manuals.



#### **WARNING**

Failure to heed could result in serious injury or death.

Ensure every individual who operates or works with this unit has read and understands all safety information.

Do not transport the scale while someone is on the scale.

Do not allow minors (children) or inexperienced persons to operate this scale.

Do not use in the presence of flammable materials.

Do not use this product if any of the components are loose or cracked.

Do not use near water.

Do not use the scale on slippery surfaces, such as a wet floor.

Do not use this scale when a person's body or feet are wet, such as after taking a bath.

Do not place fingers into slots or possible pinch points.

To avoid cross contamination, the scale should be cleaned regularly.

Prior to cleaning, make sure the scale is disconnected from the power source.

People with disabilities, or who are physically frail, should always be assisted by another person when using this scale.

**IMPORTANT**

**Do not drop the scale or subject it to violent shocks.**

**Do not jump on the scale.**

**For accurate weighing, the scale must be placed on a flat, stable surface.**

**Operating at voltages and frequencies other than specified could damage the equipment.**

**Avoid contact with excessive moisture.**

**Do not make alterations or modifications to the scale.**

**Rice Lake Weighing Systems offers optional AC adapters; utilizing an adapter not supplied by Rice Lake Weighing Systems voids all warranties and approvals.**

**Weight exceeding the maximum capacity may damage the scale.**

## 1.2 FCC Compliance

### United States

This equipment has been tested and found to comply with the limits for a Class A digital device, pursuant to Part 15 of the FCC Rules. These limits are designed to provide reasonable protection against harmful interference when the equipment is operated in a commercial environment. This equipment generates, uses, and can radiate radio frequency energy and, if not installed and used in accordance with the instruction manual, may cause harmful interference to radio communications. Operation of this equipment in a residential area is likely to cause harmful interference in which case the user will be required to correct the interference at his own expense.

### Canada

This digital apparatus does not exceed the Class A limits for radio noise emissions from digital apparatus set out in the Radio Interference Regulations of the Canadian Department of Communications.

Le présent appareil numérique n'émet pas de bruits radioélectriques dépassant les limites applicables aux appareils numériques de la Class A prescrites dans le Règlement sur le brouillage radioélectrique édicté par le ministère des Communications du Canada.

## 1.3 Disposal



### Product Disposal

The product must be brought to appropriate separate waste collection centers at the end of its life cycle.

Proper separate collection to recycle the product helps prevent possible negative effects on the environment and to health, and promotes the recycling of the materials. Users who dispose of the product illegally shall face administrative sanctions as provided by law.

### Battery Disposal

Dispose of batteries at appropriate waste collection centers at the end of their life cycle in accordance with local laws and regulations. Batteries and rechargeable batteries may contain harmful substances that should not be disposed of in household waste. Batteries may contain harmful substances including but not limited to: cadmium (Cd), lithium (Li), mercury (Hg) or lead (Pb). Users who dispose of batteries illegally shall face administrative sanctions as provided by law.



**WARNING: Risk of fire and explosion. Do not burn, crush, disassemble or short-circuit lithium batteries.**

## 2.0 Assembly

### 2.1 Unpacking

A minimum of two people should transport, unpack and assemble the scale for their own personal safety and ensure the integrity of the scale. Place the unopened box in an open area that has ample room for unpacking the scale. Use caution while removing packaging and unpacking the scale. After unpacking, visually inspect the 260-10-1 bariatric handrail scale to ensure all components are included and undamaged. If parts were damaged in shipment, notify Rice Lake Weighing Systems and the shipper immediately.

Parts contained in the shipping box include:

- Scale platform with handrail center post
- Indicator
- Handrails
- Parts kit including hardware for assembly
- Six AA non-rechargeable batteries

#### 2.1.1 Repackaging

Retain the packaging for use in the event that the scale must be returned or moved. The product must be properly packed with sufficient packing materials. Whenever possible, use the original carton and packing materials when shipping the scale back.

**!** **IMPORTANT: Damage caused by improper packaging is not covered by the warranty.**

### 2.2 Scale Setup

Use the following steps to set up the bariatric handrail scale.

1. Move the scale to the area where the weighing process will occur. Place the scale on a hard, level surface for the most accurate weighments. A 3/8 inch socket wrench (or equivalent) and a Phillips screwdriver are required for assembly.
2. A minimum of two people should carefully remove the scale by lifting it out of the box by the scale base.

**!** **IMPORTANT: Do not lift the scale out of the box by the handrail post as this may cause damage.**

3. Place the scale on the floor or other hard level surface.
4. Remove the screw knob at the base of the handrail center post



Figure 2-1. Scale in Shipping Position

5. Lift the handrail center post until it is perpendicular to the base.

6. Insert and tighten the screw knob on the base until the handrail center post is rigid and does not move.

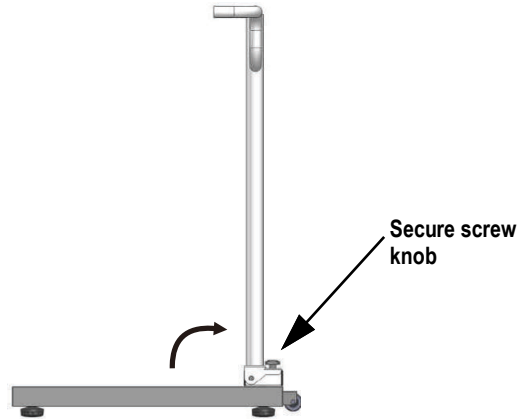

Figure 2-2. Scale in Upright Position

7. Roll back the rubber grip from each handle.

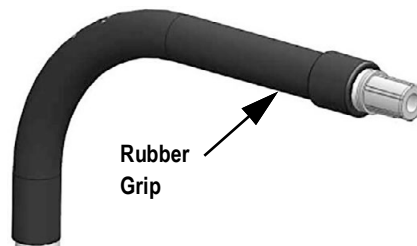

Figure 2-3. Scale Handrail

8. Insert the handles into the handrail post (Figure 2-4).

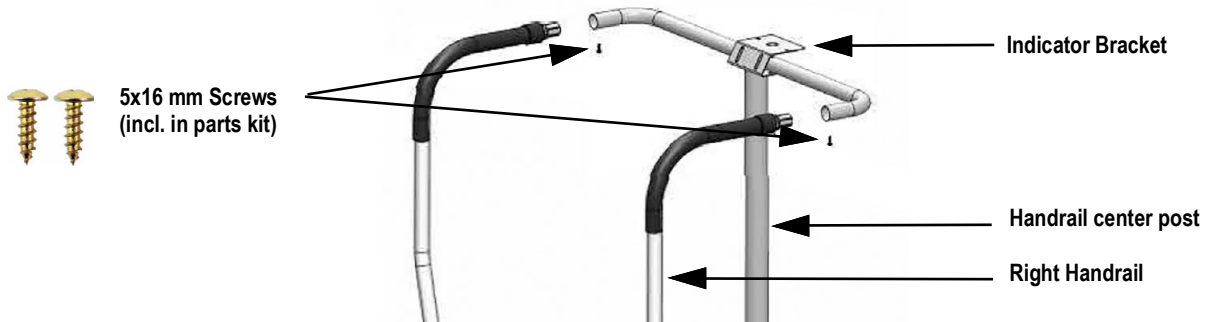

Figure 2-4. Handrail to Post Assembly

The right handrail is denoted by a red dot sticker on the base end of the handrail (Figure 2-5). This sticker may be removed after assembly.

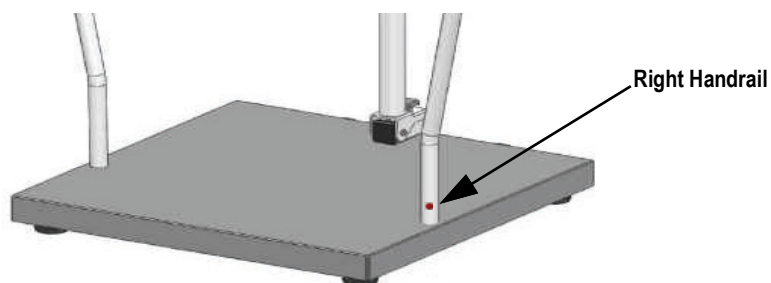

Figure 2-5. Right Handrail Designation

9. Insert the screws and tighten with a Phillips screwdriver to secure the handles to the handrail base.

- Roll the rubber grips back into position.



Figure 2-6. Rubber Grips in Proper Position

- Gently tip the scale and lay it down so that the handrail center post is touching the floor.
- Insert the bolts and washers, in the order shown, from underneath the platform and into the handrails. Tighten with a 3/8 inch socket wrench.

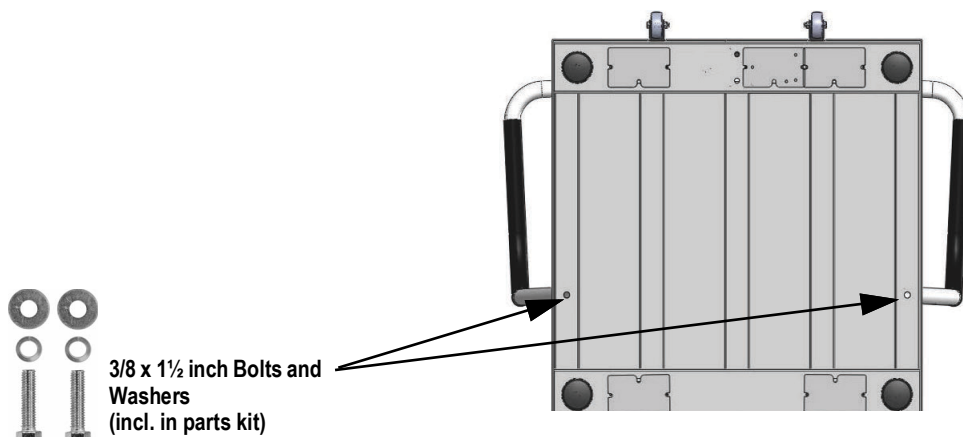

Figure 2-7. Handrail to Base Assembly

- Secure the indicator to the handrail center post by inserting two screws and washers, in the order shown, from the top plate of the indicator and through the bracket.
- Tighten with a Phillips screwdriver.

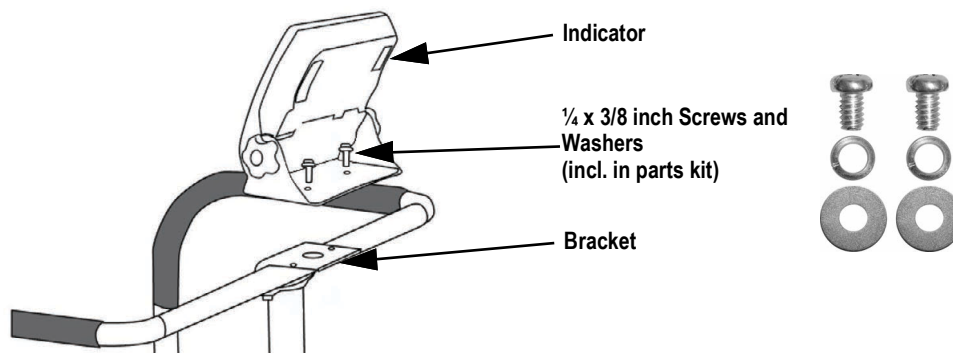

Figure 2-8. Indicator Assembly

- Remove the four screws securing the back cover to the indicator with a Phillips screwdriver.

16. Connect the cable to the indicator by plugging it into the load cell connection port.
17. Replace the back cover of the indicator and the four screws and secure with a Phillips screwdriver.

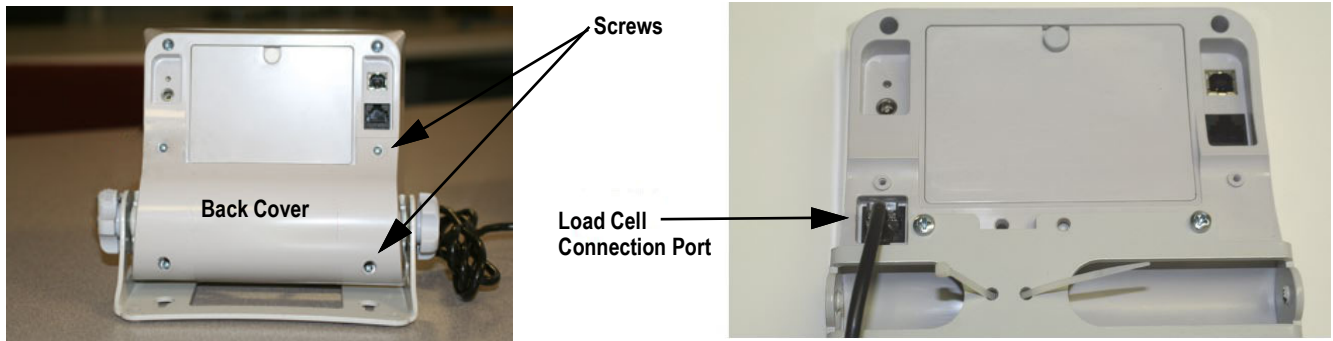

Figure 2-9. Indicator to Load Cell Cable Connection

## 2.3 Battery

Depending on model, the scale may use alkaline or rechargeable batteries. To determine which type battery is used, open the battery compartment. If six AA battery slots are available, alkaline batteries should be used. If a Y shaped crossbar is holding a battery in place, it uses a rechargeable battery and includes an AC power adapter.

### 2.3.1 Insert Alkaline Batteries

The six AA batteries supplied with the scale provide an average of 25 hours of continuous use.

To install the batteries:

1. Turn thumbscrew counterclockwise then remove battery cover.
2. Insert batteries into the battery chamber as illustrated.



Figure 2-10. Battery Chamber

3. Put the cover in place and turn the thumbscrew clockwise to secure.



**NOTE:** Remove the batteries prior to storing if the product is not going to be used for an extended period of time.



**NOTE:** If the LO BAT indicator activates, for accurate weighing, replace the batteries or connect the scale to an AC power source as soon as possible.

### 2.3.2 Power Connection

An optional AC power adapter can be used when a power outlet is available.



**IMPORTANT:** Only use power adapters supplied by or purchased from Rice Lake Weighing Systems. The use of a power adapter not from Rice Lake Weighing Systems voids the warranty.

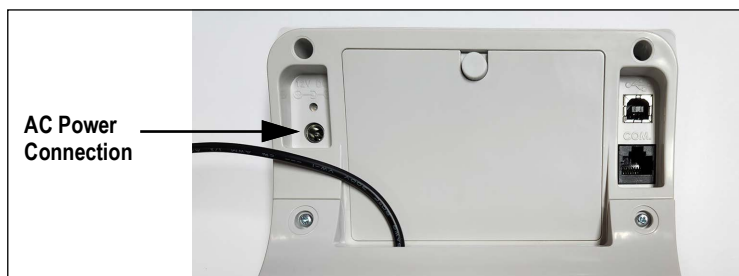

Figure 2-11. Power Connection Site



**NOTE:** The battery annunciator on the display turns off when using an AC power connection. The brightness of the backlight is reduced to 60% when using battery power.

## 3.0 Operation

This section describes the front panel and includes procedures for operation of the scale.



Figure 3-1. Front Panel Keypad

### 3.1 Key Descriptions

The display has 10 front panel keys. Key functions are described in the table below.



**IMPORTANT:** The front panel keys are very sensitive, so only a gentle press is required.













Key	Name	Function
 On/Off	On/Off	Powers the scale on or off
 Print LB/KG	Print LB/KG	Sends data out from the RS-232 port; Allows to toggle between kilograms and pounds providing that it is enabled in <b>Configuration</b> mode; Cannot toggle while in the <b>BMI</b> mode
 Zero	Zero	Only functions if the current weight is stable and less than 2% of the capacity of the scale. Anything over 2% requires a recalibration
 Hold Release	Hold Release	Displays most current weight value on the display and holds that value when the patient is off the scale. A second press releases the weight value. Not active while in <b>BMI</b> mode
	BMI	Pressing the <b>BMI</b> key enables access to the BMI (Body Mass Index) mode (defaults when scale is turned on). The patient is gets on the scale, weight stabilizes and press the <b>BMI</b> key. The display then asks for the patient height to calculate out the patient BMI.
	TARE	Used to remove the weight initially of anything on the scale that shouldn't be included in the total weight of the patient on the scale
	CLEAR	When using the BMI function, the display looks for a height entry. Pressing <b>Clear</b> changes this entry back to 190.0 cm (default) or 5 ft, 7.5 in. Once BMI is displayed, pressing the <b>Clear</b> key exits BMI
	ENTER	Used to accept height in <b>BMI</b> mode; accepts the value of the parameter last entered and moves to the next stage. Pressing and holding Enter during startup will display ID. This is the first setup on entering into configuration mode
	Up Arrows	Adjusts the value of the flashing digit/number Adjusts height input (0.5 in/0.5 cm) while in <b>BMI</b> mode
	Down Arrows	Adjusts the value of the flashing digit/number Adjusts height input (0.5 in/0.5 cm) while in <b>BMI</b> mode

Table 3-1. Key Functions



## 3.2 Weighing

Use the following steps to weigh.

1. Press  to turn on the scale. **0.0** appears on the display along with the **ZERO** annunciator.
2. Place the patient on the scale. The patient's weight is displayed, the **LOCK** annunciator is on and the indicator beeps to indicate the end of the weighing process.
3. Press  to change the display from lb to kg and vice-versa.
4. Press and hold  until **OFF** displays to turn off the scale.

## 3.3 Hold/Release Function

Use the following steps to use the Hold/Release function.

1. Press  to turn on the scale. **0.0** prompts along with **ZERO** on the display.
2. Press  once the patient's weight stabilizes. The patient's weight and the **HOLD** and **LOCK** annunciators remain on the display when the patient is off the scale.
3. Press  again to return the scale to zero.





**NOTE:** Pressing  will not work while using Hold/Release function.



**NOTE:** Pressing  prior to the patient getting on the scale will also hold the weight display.

## 3.4 Preset Tare

Use the following steps for the Preset Tare function prior to patient weighing if additional items are being used by the patient.

1. Press  to turn on the scale. **0.0** appears on the display along with the **ZERO** annunciator.
2. Place additional item(s) on the scale.
3. Press  until the display returns to **0.0** and **NET** annunciator appears on the display.
4. Remove additional item(s) from the scale. The weight displays with a negative symbol to the left of it.



**NOTE:** Not removing the additional item(s) prior to patient weighing will also work.





5. Position the patient and additional item(s) on the scale. The display identifies the patient weight. The **NET** annunciator is still active. The weight of the additional item(s) remains stored in memory for the duration of this weigh in.
6. To cancel the tare weight, remove patient from the scale and press  until **NET** disappears from the display and the display turns back to **0.0** and **GROSS** appears.



**NOTE:** Tare weight is also canceled when the scale is turned off.

## 3.5 Toggle Tare





Use the following steps to use the Toggle Tare function when the additional item to be weighed is known.

1. Press  when the scale is empty and **0.0** displays. The default values prompts while **0.0** is flashing on the display (default is programmed to be 33.0 lb/15.0 kg).
2. Use  and  to adjust the value. Press  to start the tare function. The **NET** annunciator turns on instead of the **GROSS** annunciator.





## 3.6 Using the Body Mass Index (BMI) Function

Use the following steps in determining the BMI.

### 3.6.1 LB Mode

1. Ensure that the scale is at zero.
2. Place the patient on the scale to obtain a weight. The **LOCK** annunciator appears on the display.
3. Press . The **BMI** and **FT/IN** annunciators appear on the display and a default height value of 5 feet - 7.5 inch (5 - 07.5) is flashing.
4. Use  and  to adjust the height value.
5. Press .
6. The BMI value and **BMI** annunciator are shown on the display. Press  to return to the **Weighing** mode and the BMI function will be turned off.

### 3.6.2 KG Mode

1. Ensure that the scale is at zero.
2. Place the patient on the scale to obtain a weight. The **LOCK** annunciator appears on the display.
3. Press . The **BMI** and **CM** annunciators appear on the display and a default height value of 170.0 cm (170.0) is flashing.
4. Use  and  to adjust the height value.
5. Press .
6. The BMI value and **BMI** annunciator are shown on the display. Press  to return to the **Weighing** mode and the BMI function will be turned off.

## 3.7 Troubleshooting

Refer to the following table to check and correct any failure before contacting service personnel.

Symptom	Possible Cause	Corrective Action
Scale does not turn on	Dead batteries	Replace batteries or connect to AC power
	Faulty electrical outlet	Use a different electrical outlet
	Bad power supply	Replace adapter
Questionable weight or the scale does not zero	External object is interfering with the scale	Remove the interfering object from the scale
	Display did not show 0.0 before weighing	Help the patient off the scale, zero the scale and begin the weighing process again
	Scale is not placed on a level floor	Ensure scale is level and begin the weighing process again
	Scale is out of calibration	Check the weight with a certified calibration weight
	Scale base is touching floor during a weighment	Adjust height of feet so fingers can slide between the base of scale and the floor all the way around the platform
The display shows a <b>STOP</b> message	The load on the scale exceeds the capacity of the scale	Remove the excess weight and use the scale according to manufacture specifications
The display shows <b>LO Bat</b> message	The battery is low	Replace batteries
The display shows E and Err messages as detailed below		
E06	Identifier - ADC	AD too high
E07		AD too low
E10	Overload	Scale has been overloaded. Remove load from scale
E4L	BAT	Battery low, but still usable- one bar left on indicator display
E4U		Battery low and unstable - no bars left on indicator display
E11	CAL	Calibration Error - recalibrate scale
Err 1	Load cell cable may be plugged into wrong connection port	Ensure cable is connected to the load cell connection port. <b>Note:</b> Load cell connection point is located underneath the curved plastic cover of the indicator. Remove four back retaining screws, remove curved back cover to access load cell connection point.
Err 2	Low saturation state (low A/D)	The load cell is not connected properly; Check the cables and mechanical connections; if the problem persists, replace the set of load cells
Err 3	High saturation state (high A/D)	See Err 2
Err 6	Unstable weight; Cannot calibrate	Check the load cell mechanical surroundings and ensure nothing is contacting the load cell and that the cables are properly welded
Err 7	Scale isn't moving	Make sure feet are installed on the scale. Turn the feet all the way in and then back them out three full turns, then level the scale
SAT	Damaged load cell cable	Replace load cell cable
	Load cell cable may be plugged into wrong connection port	Ensure cable is connected to the load cell connection port. <b>Note:</b> Load cell connection point is located underneath the curved plastic cover of the indicator. Remove four back retaining screws, remove curved back cover to access load cell connection point.

Table 3-2. Troubleshooting Table

## 4.0 Communication

The unit comes with an RS-232 port that enables weight data to be transmitted to other equipment, such as a computer or printer. The RS-232 cable with DB-9 connector (PN 100719) is available from Rice Lake Weighing Systems. That connection is shown in USB Connection section on the next page.

The RS-232 parameters are:

- 9600 baud (selectable in the programming mode)
- 8 data bits
- 1 stop bit
- no parity
- no handshaking

There are three methods of communication:

- Push-button keypad print
- Standard remote protocol
- Escape protocol

### 4.1 Push-button Keypad Print

With a stable, in-range weight, press and hold  for at least three seconds, or until the scale emits two quick beeps.



**NOTE:** If the scale does not beep after five seconds, release  as the weight was either in motion or out of range.

If displaying weight and not BMI, the scale will send out the following 21 character string:

```
xxxxxxxx<SP>uu<SP>mmmm<SP><CR><LF>
```

Token	Description
xxxxxxxx	Weight with decimal point and “-” sign
<SP>	Space
uu	Unit - lb or kg
mmmm	Mode - gross or net
<CR>	Carriage return
<LF>	Line feed (moves cursor down to the next line)

Table 4-1. Print Format Tokens

Example:

```
-10 Lb net = <SP><SP><SP><SP>-10.0<SP>lb<SP><SP>Net<SP><SP><SP><CR><LF>
```

```
10 Lb gross = <SP><SP><SP><SP><SP>10.0<SP>lb<SP>Gross<SP><CR><LF>
```

- The scale will send out the following data while in **BMI** mode (displaying the BMI value):

Setting	Value
Gross Weight	215 Lb
Tare Weight	0.0 Lb
Net Weight	215 Lb
Patient Height	6-01.0 ft
Patient BMI	28.4

Table 4-2. BMI Data

## 4.2 USB Connection

The scale has the capability of connecting to a Windows® computer (PC) using a USB cable (not included) and a terminal emulation program. A terminal emulation program allows the transfer of data between the scale and PC using a serial port.



Figure 4-1. Connection Ports



**NOTE:** Apple® and Macintosh® computers are unable to transfer the necessary data to the scale. Only use a PC for data transfer.

Connecting software and downloads should always be addressed by the IT department for safety reasons and can vary depending on what type of computer platform is being used.



**NOTE:** Consult the IT department if driver protections are preventing the use of the USB driver. Driver protections may need to be temporarily disabled on Windows 10 or later computers to allow for the installation of the USB driver.

1. Connect the scale's indicator to a PC using a USB-Type B to USB-Type A cable (not included).
2. Turn the indicator on.



**NOTE:** In most cases, the PC should find the driver and automatically configure the driver when the scale is plugged into a USB port.

3. Open a terminal emulation program, such as Advanced Serial Port Terminal, pUttY or Hercules (used in this example).
4. Connect to the serial port assigned by the PC (COM5 in example). This can be found in Device Manager. Once selected, press **Open**.

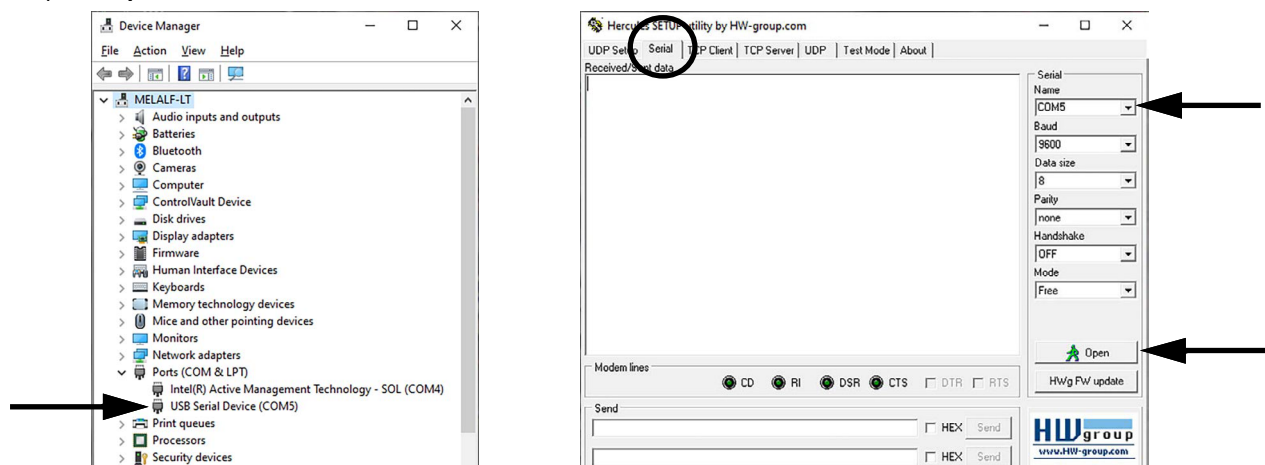

Figure 4-2. Connecting to a Serial Port

5. With weight on the scale, press and hold the **Print** button on the indicator for three seconds. The patient's weight is sent to the PC.

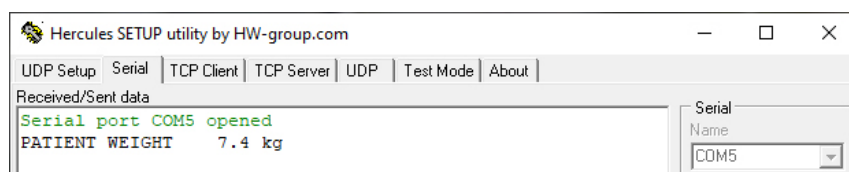

Figure 4-3. Patient Weight Displayed

## 5.0 Maintenance

The following section provides instructions for maintaining and cleaning the unit.



**IMPORTANT: Do not immerse the scale in cleaning or other liquid solutions.**

**Do not use Isopropyl alcohol or other solutions to clean the indicator display surface.**

### 5.1 Basic Maintenance

Before the first use of the scale and after periods of non-use, check the scale for proper operation and function. If the scale does not operate correctly, contact a qualified service personnel.

Go through the following steps for basic maintenance.

- Check the overall appearance of the entire scale for any obvious signs of damage
- Inspect the condition of the AC power adapter cord for cracking, fraying or for broken or bent prongs

### 5.2 Cleaning

Proper care and cleaning is essential to ensure a long life of accurate and effective operation. Before beginning the cleaning process, disconnect the scale from the AC power source.

- Clean all external surfaces with a clean, damp cloth or tissue. Mild soap and water solution may be used. Dry with a clean soft cloth
- Do not immerse the scale into cleaning or other liquid solutions
- Do not use Isopropyl alcohol or other solutions to clean the display surface

### 5.3 Periodic Maintenance

Refer to the following table for periodic maintenance guidelines:

Task	Process	Daily/Weekly	Quarterly	Per Local Regulations
Routine Cleaning	Remove dirt, dust and debris	X		
Ensure scale is level	Check level and adjust scale feet as needed	X		
Test repeatability and accuracy	Place a minimum of 5% of full scale capacity on the scale 3 times in each quadrant		X	
Inspect for damage	Check AC power adapter, hinges, etc for visible damage or missing parts		X	
Calibrate	Perform certified calibration			X
Certification	Review and renew test weight certifications			X

Table 5-1. Periodic Maintenance

## 6.0 Optional Accessories

### 6.1 Height Rod (PN 172958)

The optional height rod can be attached to the 260-10-1 bariatric handrail scale and the combination provides a single, convenient multi-purpose station for obtaining height and weight on individual patients.

#### 6.1.1 Unpacking the Height Rod

Parts contained in the shipping box include:

- Height rod with attached bracket
- Bracket insert
- Two screw knobs

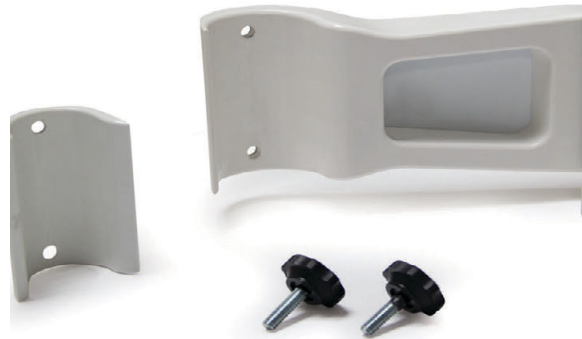

Figure 6-1. Height Meter Parts

After unpacking, visually inspect the height rod to ensure all components are included and undamaged. Contact Rice Lake Weighing Systems and the shipper immediately if the height rod was damaged during shipping.

#### 6.1.2 Assembling the Height Rod

The height rod must be attached to the 260-10-1 scale handrail center post using the following steps.

1. Insert the bracket insert into the bracket. The bracket insert is slightly more flared on one side and this must be placed toward the height rod. If the bracket insert is inserted incorrectly, there will be a gap between the bracket insert and the bracket on the outside edge. When inserted correctly, the outside edges of the bracket and the bracket insert will snugly and be flush.



Figure 6-2. Bracket Insert Placement

2. Insert the screw knobs through the holes in the bracket and the bracket insert. See [Figure 6-2](#).

3. Working from the back of the scale and facing the handrail center post, tilt the top edge of the height rod assembly and insert the height rod between the handrail and the handrail center post. Raise the top edge of the height rod so it runs parallel to the handrail center post. See [Figure 6-3](#).
4. Position the bracket and the screw knobs to line up with the holes in the back of the handrail center post.
5. Tighten the screw knobs until the bracket is rigid and does not move.



Figure 6-3. Secure Height Meter Assembly to Scale

6. Verify the height rod by measuring an object of known height and adjust, if necessary.

The Rice Lake 260-10-1 Bariatric Handrail Scale and height rod assembly is now ready for use.

### 6.1.3 Using the Height Rod

The height rod can measure persons from 25½ - 83 inches (65 - 211 cm). The inner section of the height rod slides through the outer section, raising and lowering the headpiece to easily accommodate persons of different heights.

1. Raise the headpiece until it is perpendicular to the height rod and snaps into place.
2. Raise the inner section of the height rod until the person can easily walk under the headpiece.

For persons shorter than 55 in (139 cm)

3. Lower the inner section of the height rod until the headpiece just touches the top of the persons head.
4. Read the height measurement at the red line underneath the headpiece next to the meter.

For persons taller than 55 in (139 cm)

5. Lower the inner section of the height rod until the headpiece just touches the top of the persons head.
6. Read the height measurement at the red line on the outer section of the height rod.

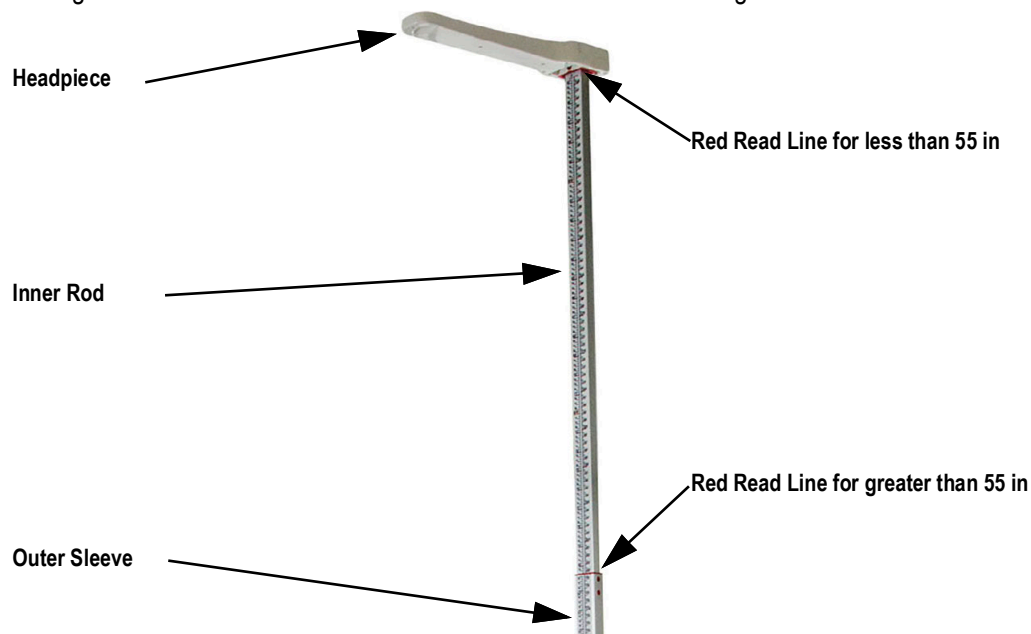

Figure 6-4. Height Rod Measurement Parts

## 7.0 Specifications

---

### Power

Optional AC Adapter - 120 VAC-9VDC-60Hz or 230 VAC

### Battery Type

6 AA size non-rechargeable alkaline batteries

### Battery Use

25 hours continuous use

Automatic power-off can be configured

### Data Communications

RS-232 with RJ-45 jack

USB connection

Selectable baud rate, default - 9600

8 bits

No parity

1 stop bit

No handshaking

### Environmental

Operating Temperature 50°F to 104°F (10°C to 40°C)

Storage Temperature 32°F to 158°F (0°C to 70°C)

Humidity 85% relative humidity

### Capacity

800 lb x 0.2 lb (360 kg x 100 g)

### Dimensions

Platform Dimensions 23½ in W x 23½ in L x 2¾ in H

Overall Height 33½ in

Height w/ Height Rod (optional) 87½ in