

powered by
heartisense[®]

Upgrade Kit BASICBilly+ Basic Life Support BASICBilly+ Manikin

> CONTENTS

1. Product Introduction	
1.1. What is the Upgrade kit?.....	3
2. Components of the product	
2.1. Hardware.....	4
2.2. BASIC <i>Billy</i> + Software applications	5
3. Hardware installation	
3.1. Installing the Upgrade kit.....	6
3.2. Installing the lung bag.....	7
4. Software installation	
4.1. Installing the apps.....	8
5. Preparation for use	
5.1. Checking the power of the kit	9
5.2. Initial connection and set-up.....	9
5.3. What is ColorID?	9
5.4. Assigning ColorID	10
5.5. Resetting ColorID	10
6. Main features of the application	
6.1. Tab menu.....	11
6.2. Learning using the Student app	12
6.3. Training using the Instructor app	14
7. Feedback & Graph UI	
7.1. Compression & Breath Feedback UI	18
7.2. Graph UI (for Instructor app only).....	18
8. More Features	
8.1. Reviewing saved data.....	19
8.2. Exporting the result/certificate as a PDF file.....	20
8.3. Renaming the manikin	21
8.4. Renaming the student name (for Instructor app only).....	22
8.5. Checking the connected kit information.....	23
8.6. Changing the settings.....	24
9. Maintenance	
9.1. Checking the remaining battery level of the kit.....	25
10. Troubleshooting	
10.1. Frequently Asked Questions	26
10.2. Troubleshooting	27
11. Warranty	28
12. Contact	28

BLS MANIKIN BASIC*Billy*+

> 1. PRODUCT INTRODUCTION

1.1. What is the BASIC*Billy*+ Upgrade kit?

As a sensor kit installed in the Basic Life Support *Billy* manikin the Upgrade kit provides feedback regarding the CPR action in real-time, allowing users to have a complete training experience. CPR feedback can be received in real time by connecting the Upgrade kit installed to the mobile applications. The application provides feedback for the compression (depth, recoil, rate), breath (volume) and hands-off time in real-time, and the feedback and evaluation standard meets the latest guideline of the American Heart Association (AHA). CPR add-on kit apps for the BASIC*Billy*+ Upgrade kit consist of a Student and an Instructor app.

Upgrade kit 4points

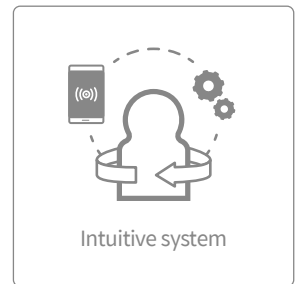
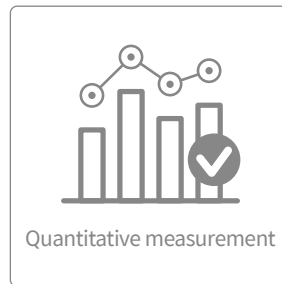

CPR add-on kit Student



CPR add-on kit Instructor

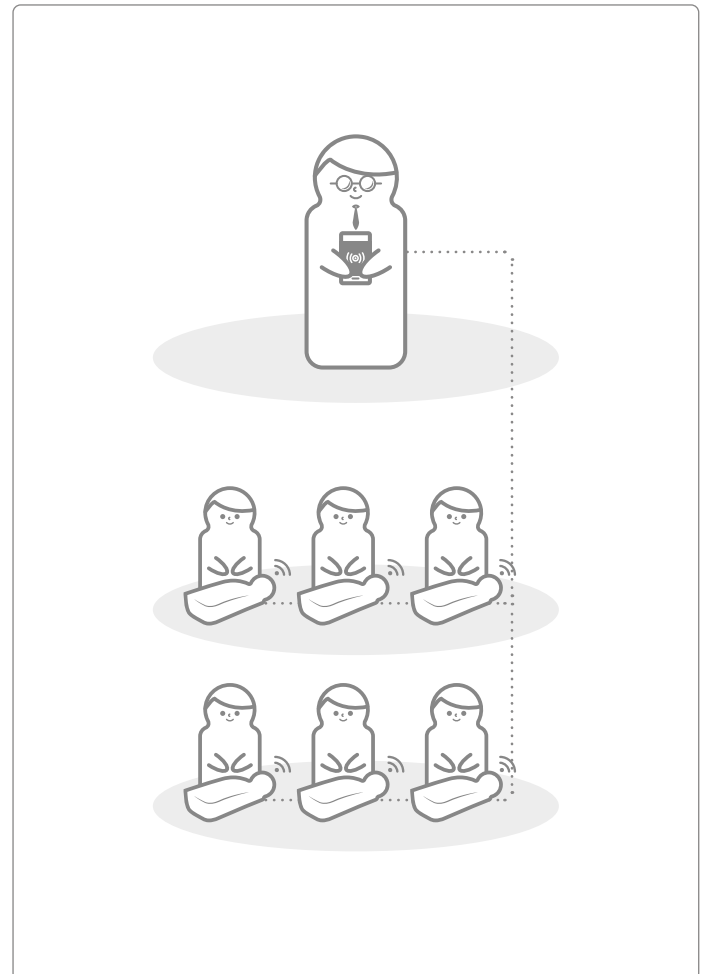

BLS MANIKIN BASICBilly+

> 2. COMPONENTS OF THE BASICBilly+

2.1. Hardware

BASICBilly+ Upgrade kit

The Upgrade kit sends compression and breath data to the mobile device application in real time.

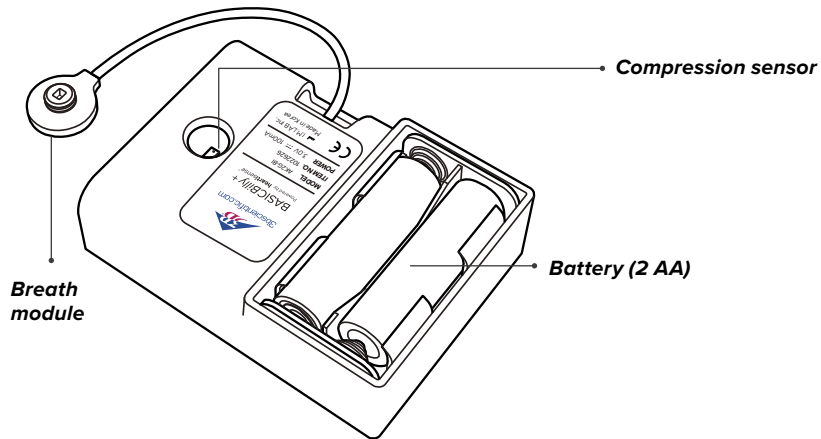

Lung bag

The lung bag is connected to the breath module and can measure the volume and timing of breath.

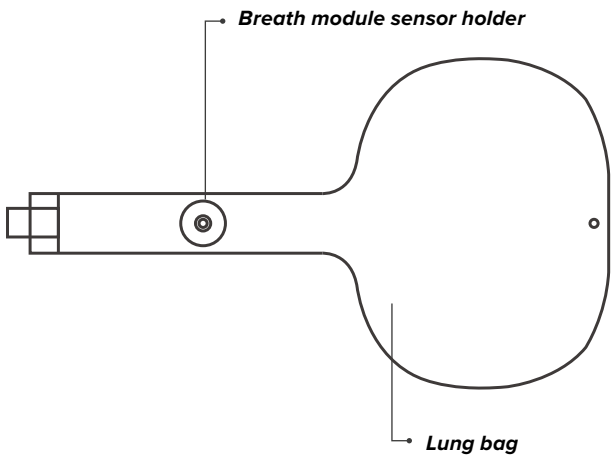

ColorID stickers

Users can use ColorID stickers to identify their BASICBilly+, during the initial set-up of the first connection. (Please refer to section 5 for further details.)

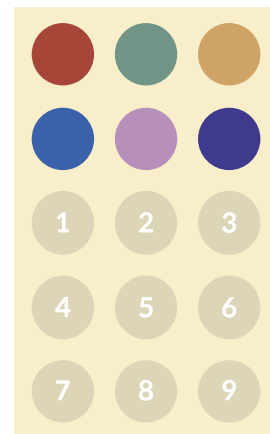

BLS MANIKIN BASICBilly+

2.2. BASICBilly+ Software applications

CPR add-on kit Student application

The Student app is a learning application and this software analyzes CPR carried out by a student in real time and gives feedback.



- Measures the CPR performance and gives real-time feedback
- Saves and converts measured data into a score
- Reviews and exports the saved score

CPR add-on kit Instructor application

The Instructor app is a training application that enables the monitoring of CPR carried out by a student or more in real time and helps with evaluation, recording and management of the results.



- Supports connection with up to 6 manikins at a time.
- Measures the CPR performance and gives feedback
- Saves and converts measured data into a score
- Reviews and exports the saved score

Supported device and version



Android Devices
Devices released after 2017
Android 6.0 (Marshmallow) or later
BLE 4.2 or later



iOS Devices
iOS 11.0 or above
BLE 4.2 or above

> 3. HARDWARE INSTALLATION

3.1. Installing the BASICBilly+ Upgrade kit

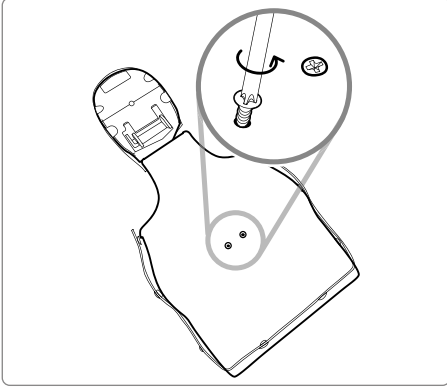

1) Disassemble two screws from the back of the manikin. If the screws are not installed on your version please proceed to the next step.

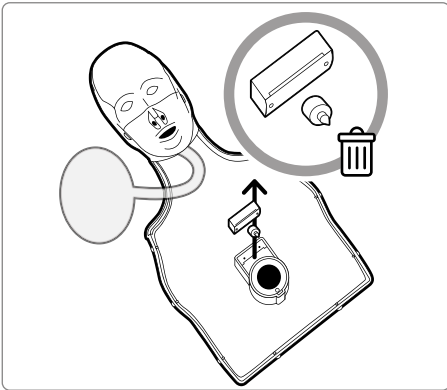

2) Take off the manikin skin, and disassemble the clicker located next to the spring from the manikin. Store it separately or discard it.

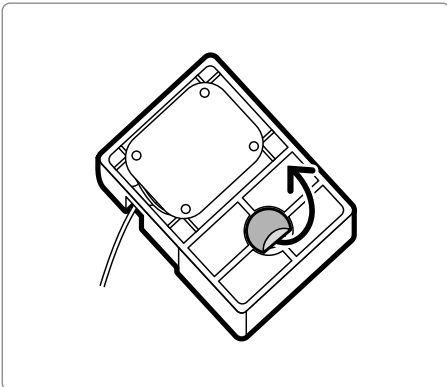

3) Take off the protective film from the sticker on the back of your Upgrade Kit.

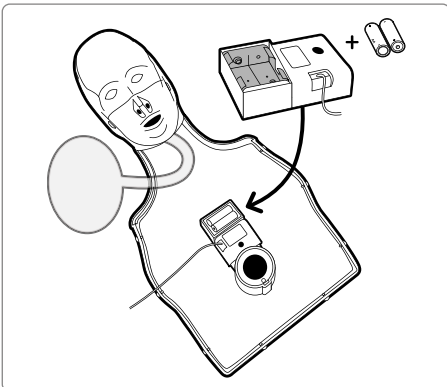

4) Install the Upgrade kit inside the BASICBilly so the kit can fit the frame and make sure the hole on the kit has been placed towards the spring.

When the batteries are inserted correctly, the kit should make the beeping sound, signaling the power is ON..

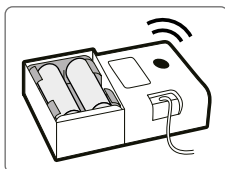

BLS MANIKIN BASIC*Billy*+

3.2. Installing the lung bag

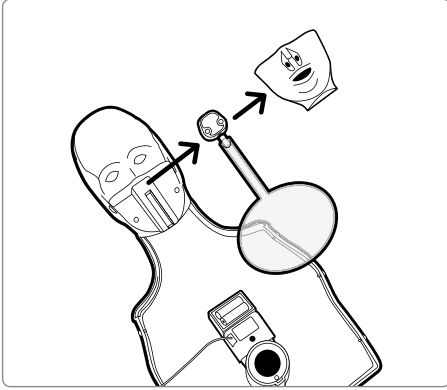

1) Disassemble manikin's mouth in order to change the lung bag more easily.

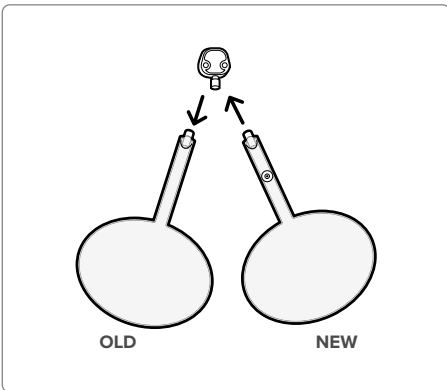

2) Remove the lung bag which is not equipped with the Breath module holder and install the new lung bag delivered in the Upgrade kit.

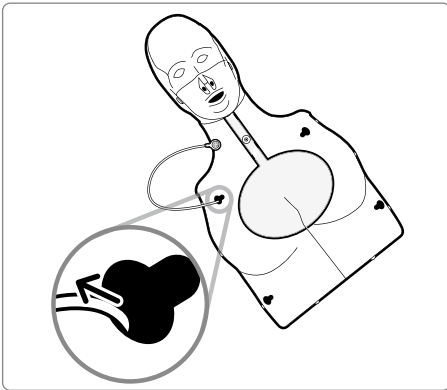

3) When assembling chest frame back to the manikin, do not forget to pass the breath module through the left top hole on the chest frame

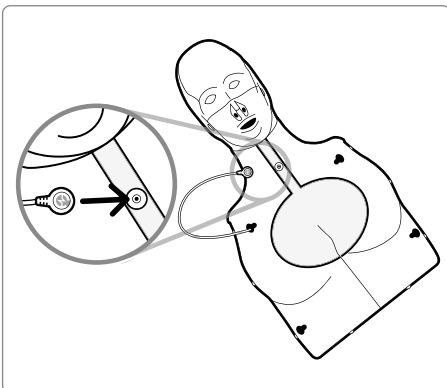

4) Attach the Breath module to the breath module holder situated on the lung bag. Put back the skin of the manikin and make sure the lung bag is not strangely folded.
The BASIC*Billy*+ is now ready to be used !

> 4. SOFTWARE INSTALLATION

4.1. Installing the apps

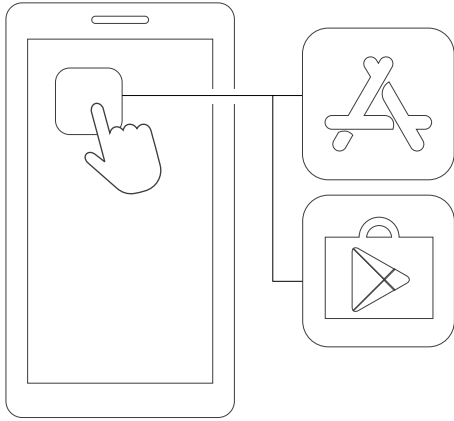

1) Connect to the App Store (iOS) or Google Play Store (Android).

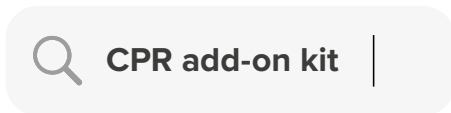

2) Search for CPR add-on kit.



**CPR add-on kit
Student**

3) Download the Student app or the Instructor app.



**CPR add-on kit
Instructor**



> 5. PREPARATION FOR USE

5.1. Checking the power of the kit

Make sure the kit makes beeping sound when the batteries are inserted. Beeping sound means the power is on.

If there is no input (chest compression or breath delivery, or both) for more than 10 minutes while the power is on, the kit will turn off automatically.

To turn On the manikin, perform some chest compressions. If you hear the beeping sound again, the BASICBilly+ is On. .



5.2. Initial connection and set-up

When the BASICBilly+ is connected for the first time, assign ColorID and perform breath calibration will be needed. This will only be requested during the initial connection of the your manikin.

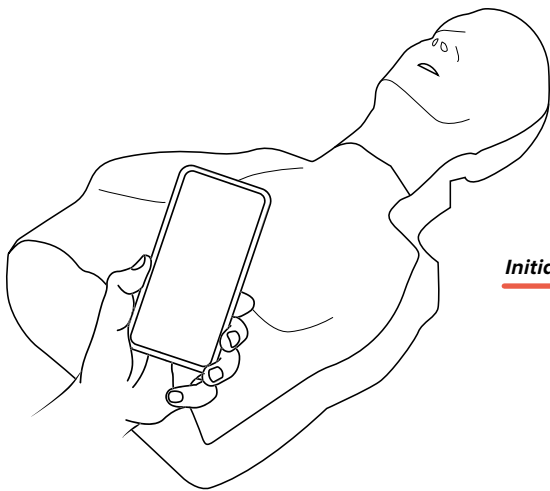

Initial connection →

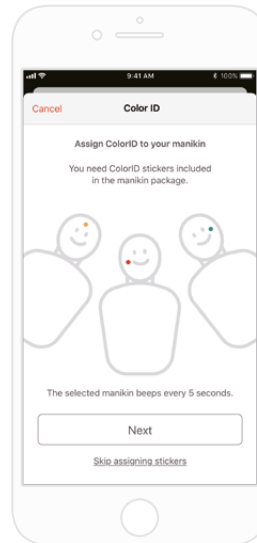

Setting ColorID
(Refer to sec. 5.3)

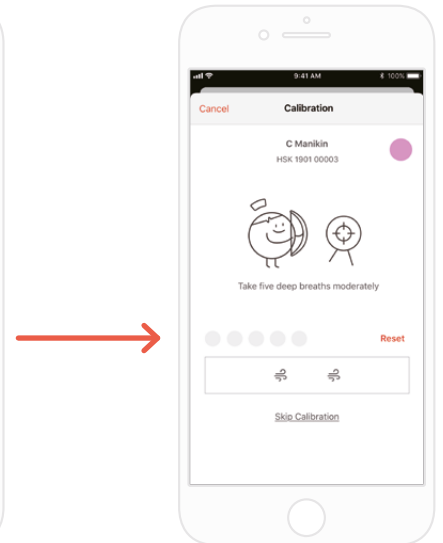

Calibrating Breath module
(Refer to sec. 6.2 and 6.3)

5.3 What is ColorID?

The ColorID feature help you to identify and differentiate each BASICBilly+. The color sticker and number sticker assigned a unique ID to your manikin.

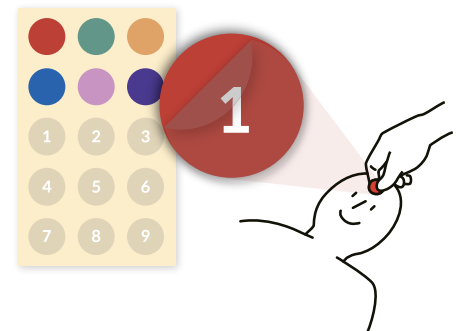

BLS MANIKIN BASICBilly+

5.4. Assigning ColorID

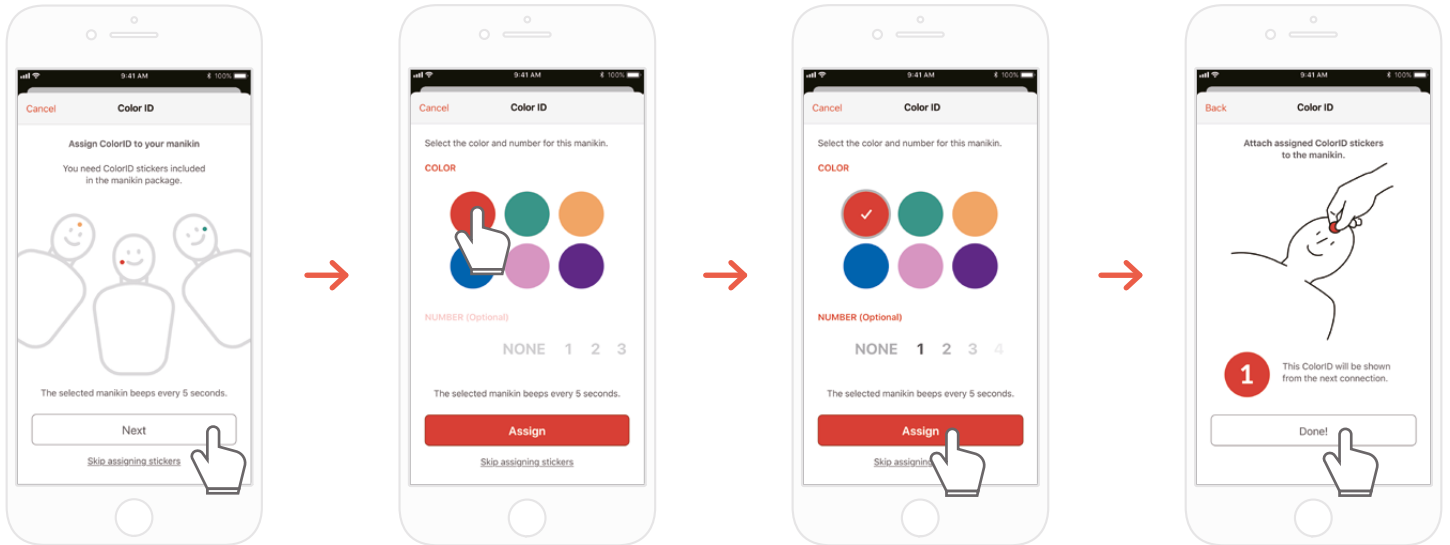

- 1) When a new BASICBilly+ kit is connected to the CPR add-on kit application for the first time, the ColorID set-up is automatically initiated. During the set-up, the connected manikin will beep constantly each 5 seconds so you can identify him.
- 2) Choose a color + number combination you want to assign to this manikin (Choosing color is mandatory.)
- 3) When you select 'Assign', the ColorID assignment is completed.
- 4) Stick the corresponding color and number stickers on your manikin.

5.5. Resetting ColorID

ColorID for each kit may be re-set.

[Student App]

- Change ColorID by tapping ColorID icon on the left bottom of connected manikin screen, shown on the main screen
- You may also change ColorID from 'Kit information' from 'Settings' tab.

[Instructor App]

- Choose each manikin slot from 'Link' tab, then choose 'Change' on ColorID slot.

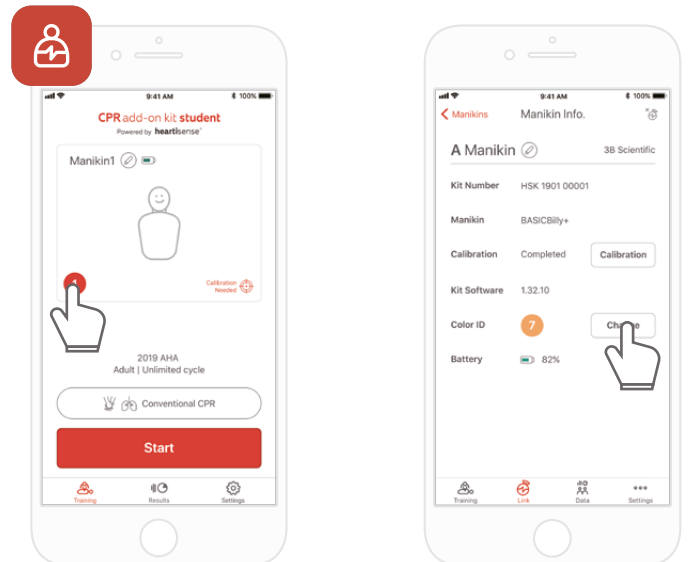

> 6. MAIN FEATURES OF THE APPLICATION

6.1. Tab menu

CPR add-on kit Student app

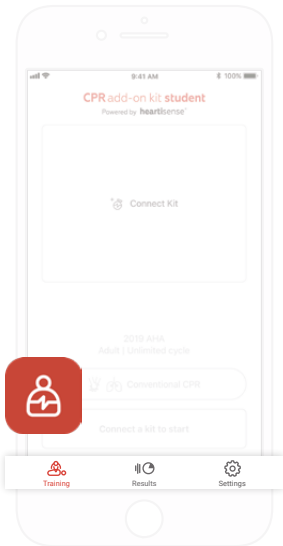

The CPR add-on kit Student app consists of the following tabs.



Training

You can monitor CPR performance in real time.



Results

You can manage saved training records.



Settings

You can adjust the settings applied to the training including the guideline and score calculation settings.

CPR add-on kit Instructor app

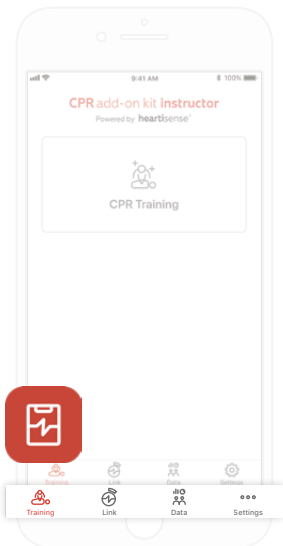

The CPR add-on kit Instructor app consists of the following tabs.



Training

You can select the measurement method and monitor CPR performance in real time.



Link

The connected manikin information is displayed, allowing you to check the status before carrying out training.



Data

You can manage saved training, evaluation records and student list.



Settings

You can adjust the settings applied to the training including the guideline and score calculation settings.

BLS MANIKIN BASICBilly+

6.2. Learning using the Student app

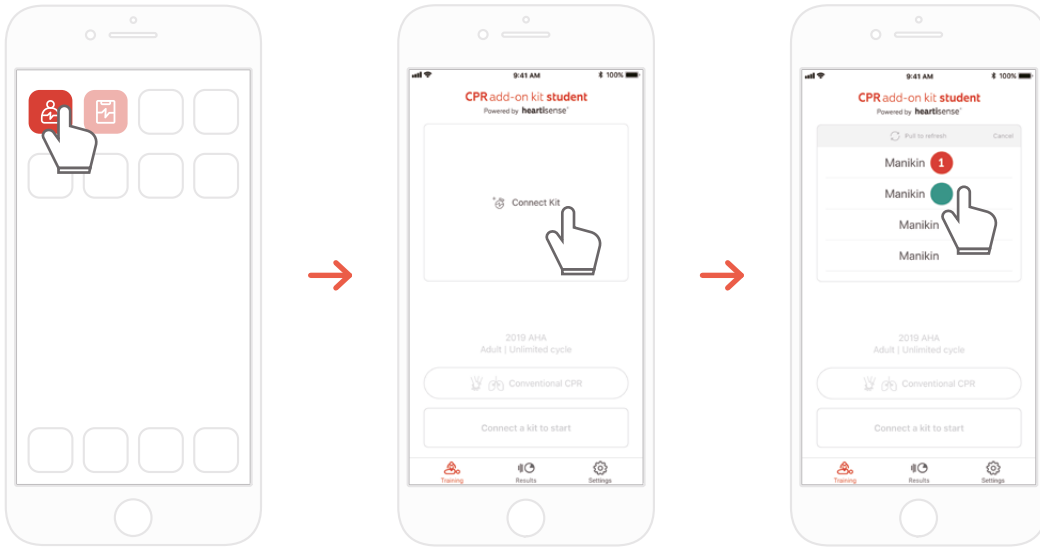

- 1) Run the CPR add-on kit Student and then select Connect Kit on the main screen.
- 2) Select the desired manikin ID from the list to begin the Bluetooth connection.

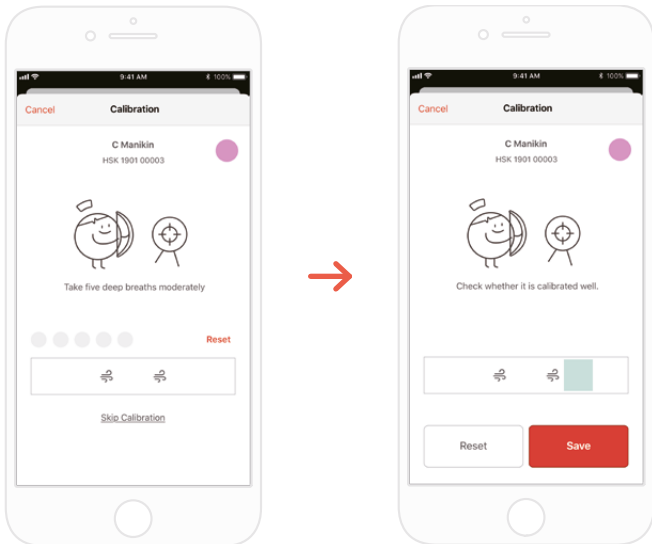

- 3) When the kit is connected to the app for the first time, the breath module should be calibrated. The calibration screen will pop up automatically.

*Deliver a proper volume of breath 5 times as instructed on the screen and press the Save button.

BLS MANIKIN BASICBilly+

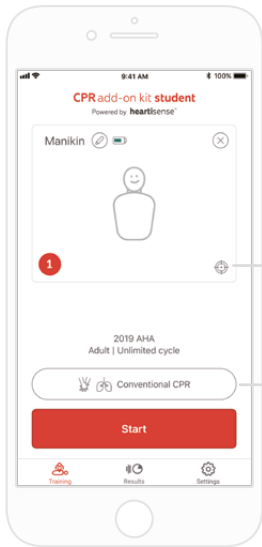

4) When the Bluetooth connection is made successfully, the manikin information will be displayed on the screen. Select the evaluation item(s), measuring compression only or both compression and breath.

* You can calibrate the breath sensor by selecting the target-shaped icon.



If the breath sensor is calibrated



If the breath sensor is not calibrated

* You can set the metric of measurement

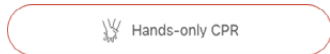

Evaluation is carried out based on the hands-only CPR.

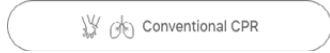

Evaluation is carried out based on the CPR (30:2).

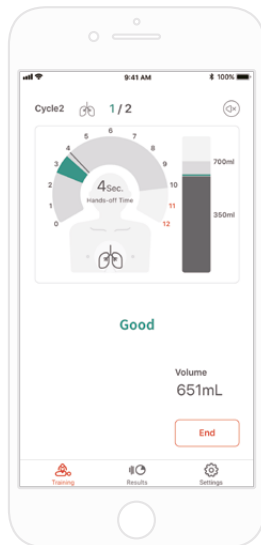
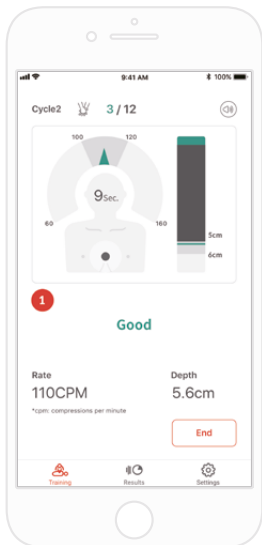

After the session →

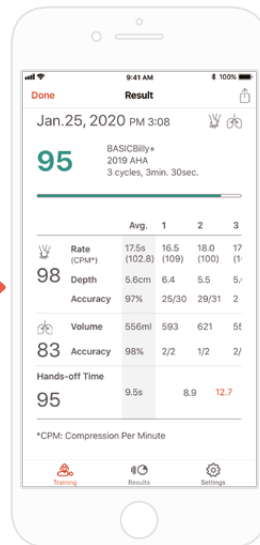

5) When a user performs CPR, the application gives feedback for the compression or breath.

6) When CPR is completed, the measured data will be shown in numerical figures.

BLS MANIKIN BASICBilly+

6.3. Training using the Instructor app

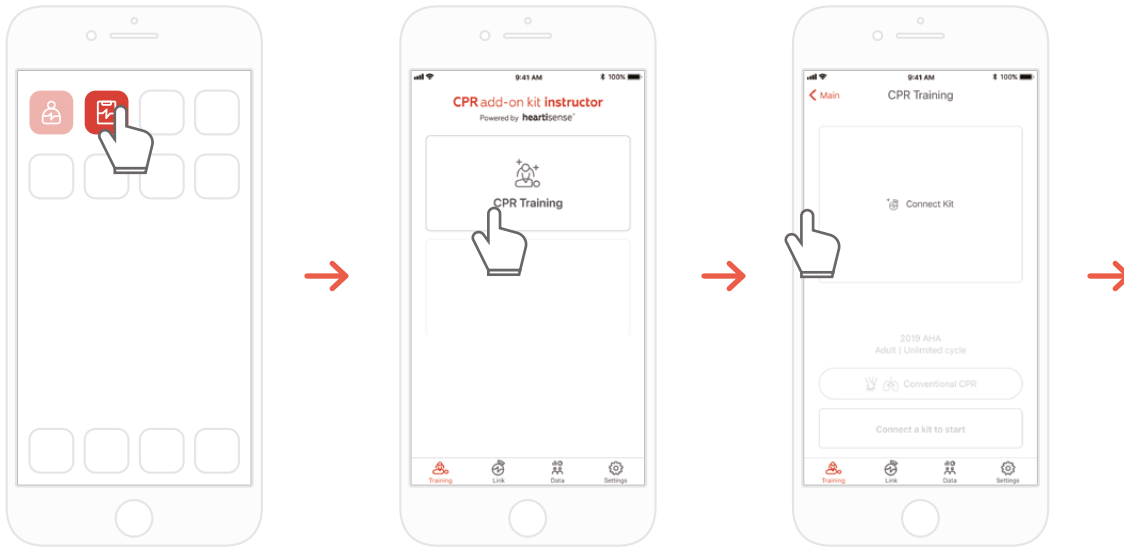

1) Run the CPR add-on kit Instructor and select 'CPR training' on the main screen.

2) When you press 'Connect Kit', available kits for connection will be showed.

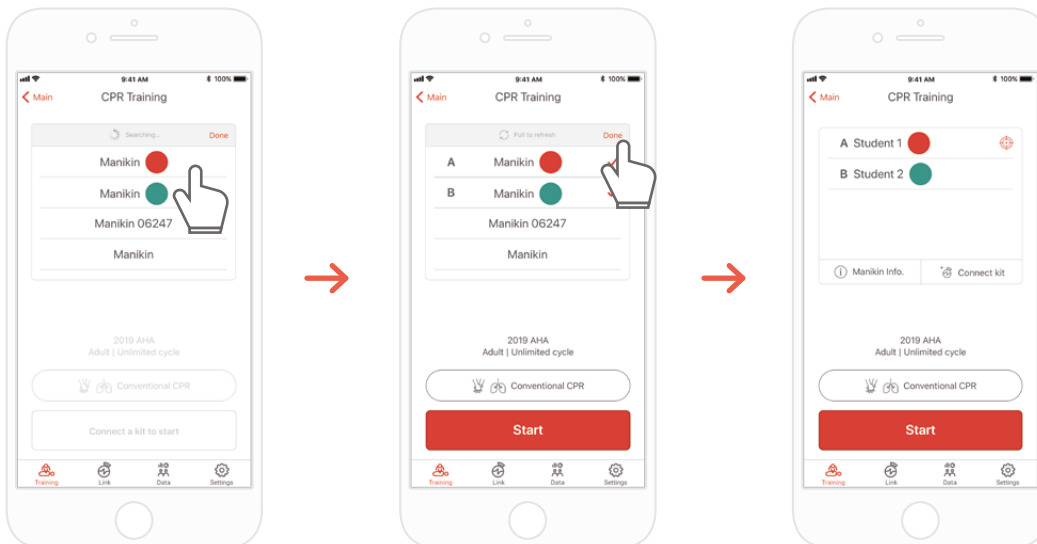

3) Select the BASICBilly+ you wish to connect from the list and wait for the establishment of the Bluetooth connection.

4) When the connection is made, press the 'Done' button to end searching for other manikins

BLS MANIKIN BASICBilly+

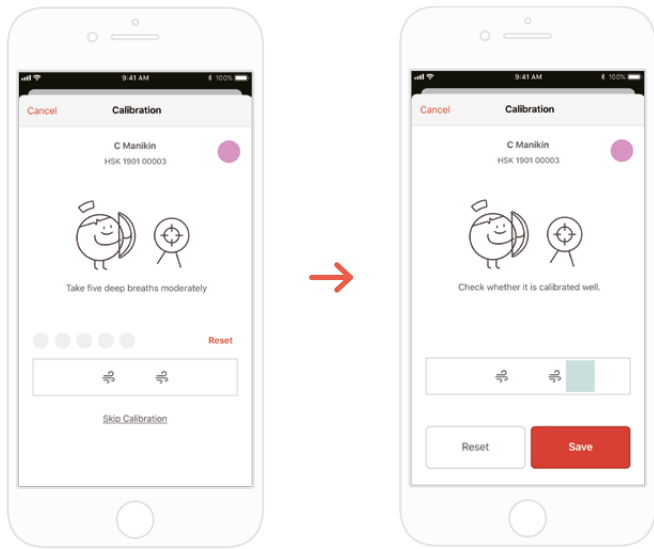

5) When the kit is connected to the app for the first time, the breath sensor should be calibrated. The calibration screen will pop up automatically.

*Deliver a proper volume of breath 5 times as instructed on the screen and press the Save button.

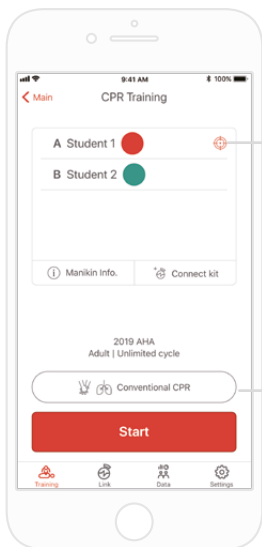

When the Bluetooth connections are made successfully, students will be shown on the screen.

* You can calibrate the breath sensor by selecting the target-shaped icon.



If the breath sensor is not calibrated

* You can set the metric of measurement

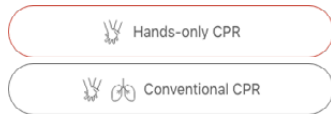

Evaluation is carried out based on the hands-only CPR.

Evaluation is carried out based on the CPR (30:2).

BLS MANIKIN BASICBilly+



7) The CPR add-on kit Instructor app can monitor up to 6 students. You can add a kit through the icon on the top right corner while evaluating.

*Refer to '7.1 Compression & Breath Feedback UI' for information regarding the feedback displayed on the screen.

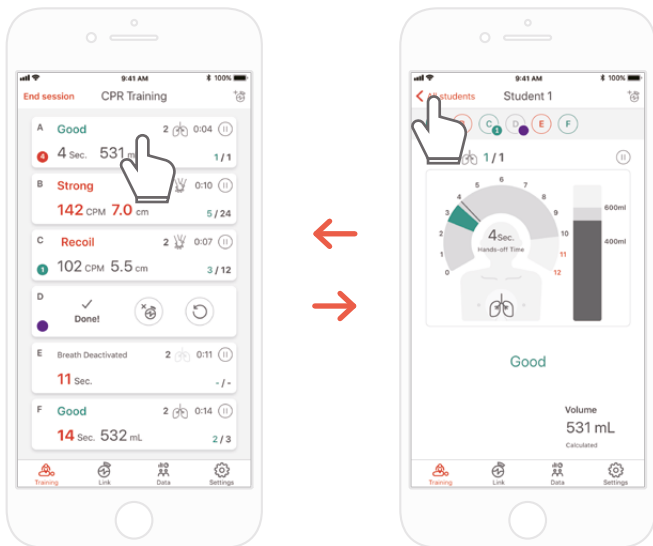

8) In case a student has difficulties during his training you will be notified by red feedback on his student's slot. You can then select his slot and check his CPR performance in detail.

*On the 'Detailed view' screen, you can press the back arrow button to return to the previous screen or press the different student ColourID at the top of your screen which will enable you to navigate between the detail view of the other student.

BLS MANIKIN BASICBilly+

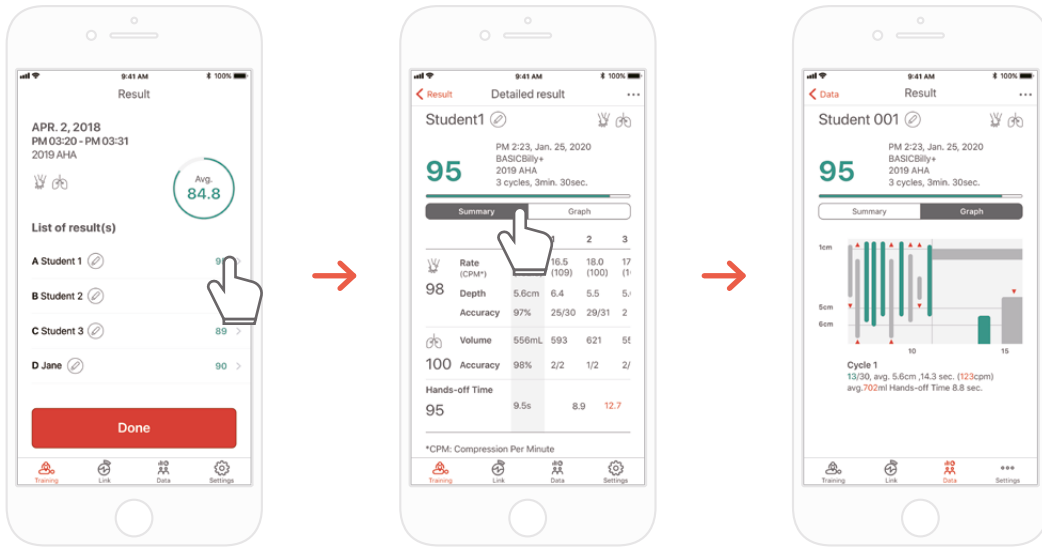

9) You can review CPR performance data with a summary view or a graphic view.

*Refer to '7.2. Graph UI (Instructor app)' for information regarding graph view

To connect a number of manikins at the same time, connect them from the list in consecutive order and press the 'Done' or 'Start' button without searching for them repeatedly.



If there is a kit which is not calibrated among the kits, the calibration screen for the relevant kit will pop up immediately. You can connect manikins continuously after completing the calibration.

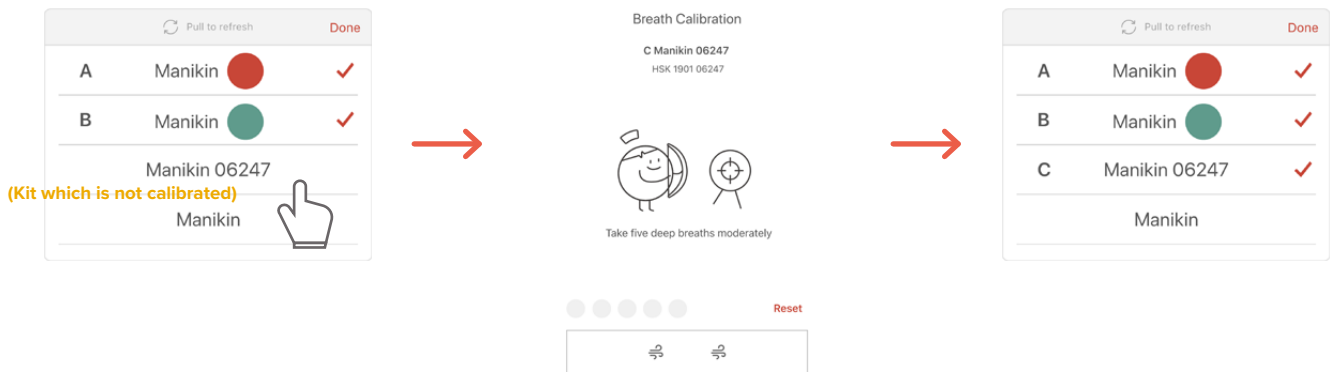

BLS MANIKIN BASICBilly+

7. FEEDBACK & GRAPH UI

7.1. Compression & Breath Feedback UI

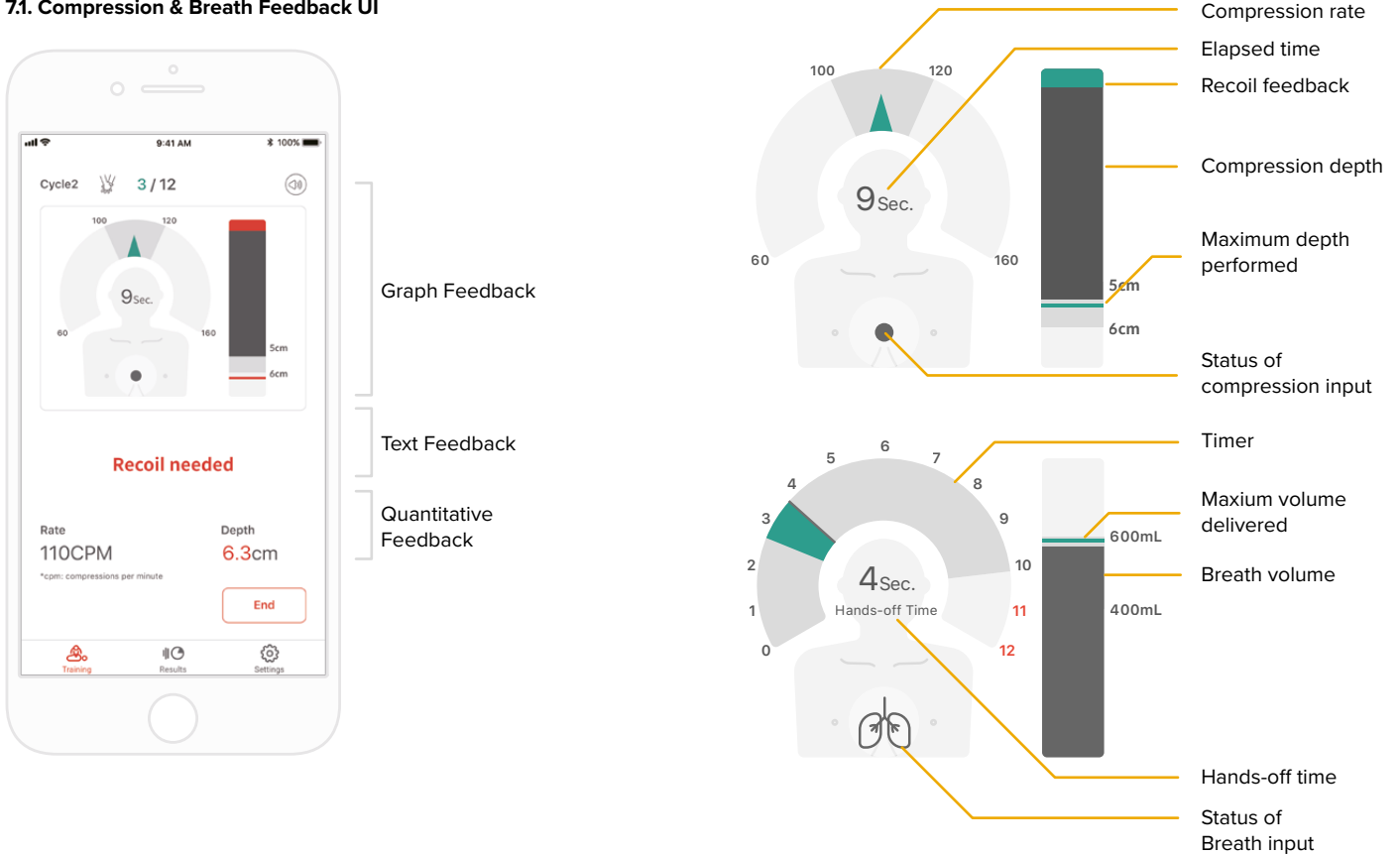

7.2. Graph UI (for Instructor app only)

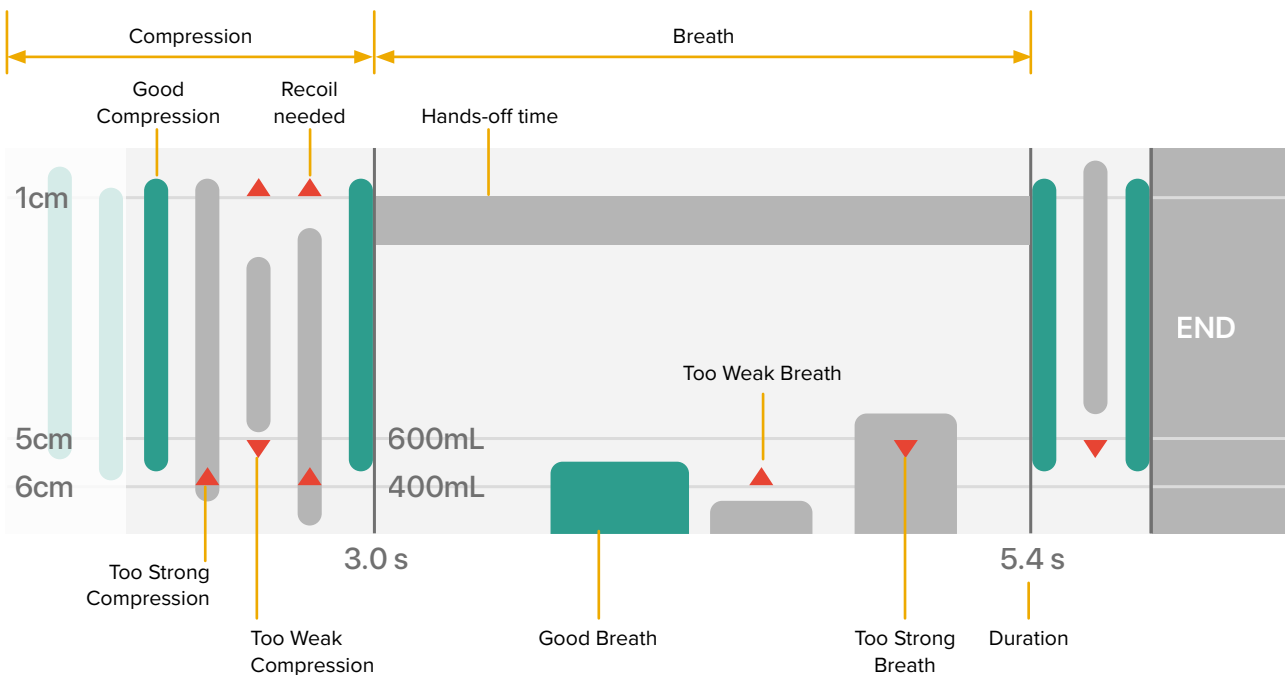

➤ 8. MORE FEATURES

8.1. Reviewing saved data

CPR add-on kit Student

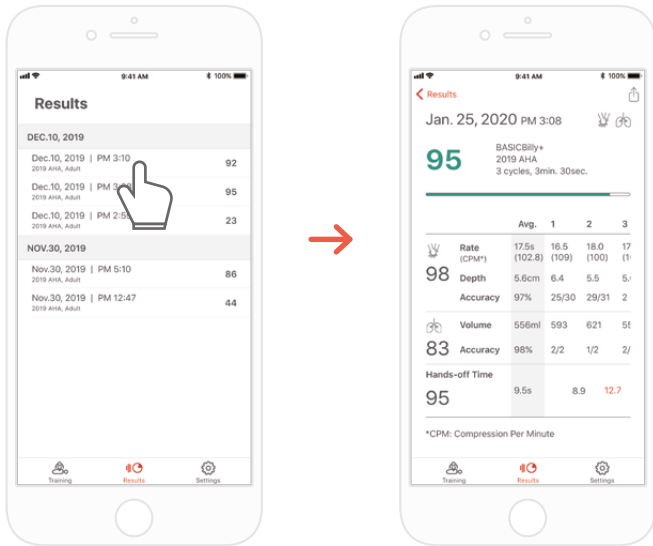

CPR add-on kit Instructor

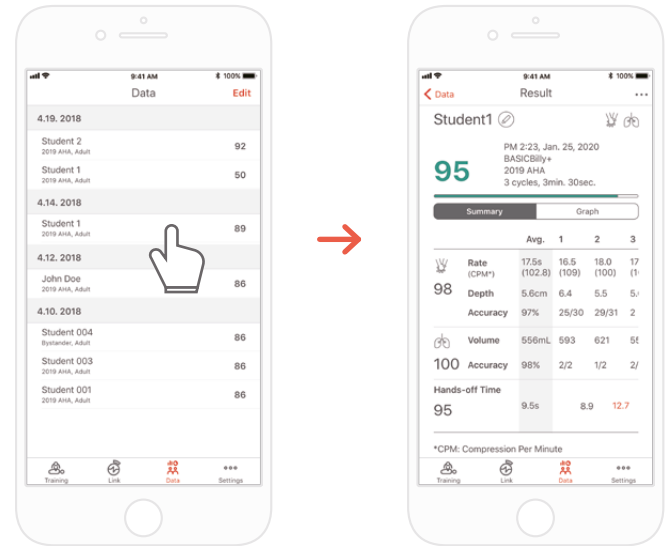

The 'Result' tab of the Student app



The 'Data' tab of the Instructor app

Deleting the result from the list (common for both the Instructor and Student apps)

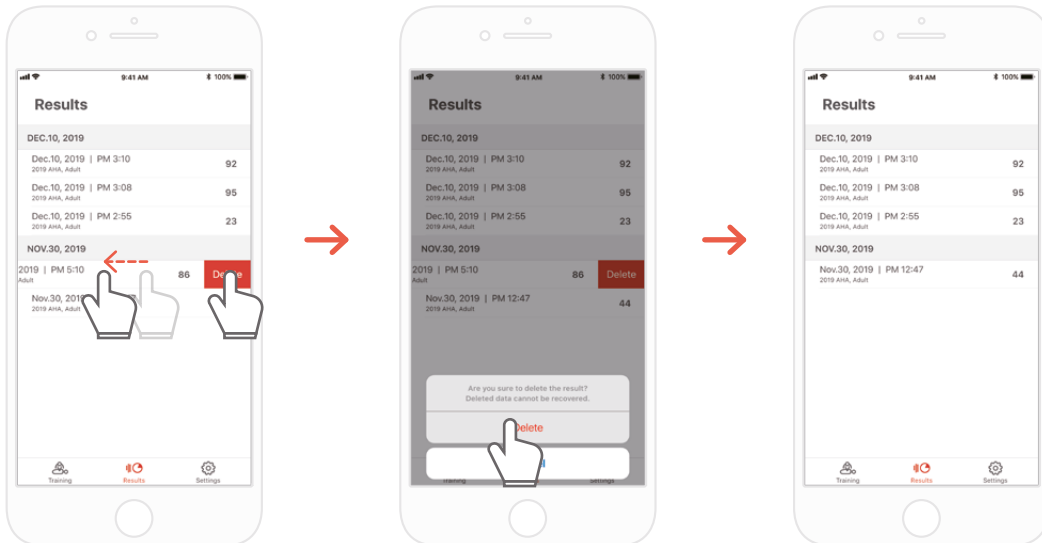

BLS MANIKIN BASICBilly+

8.2. Exporting the result/certificate as a PDF file

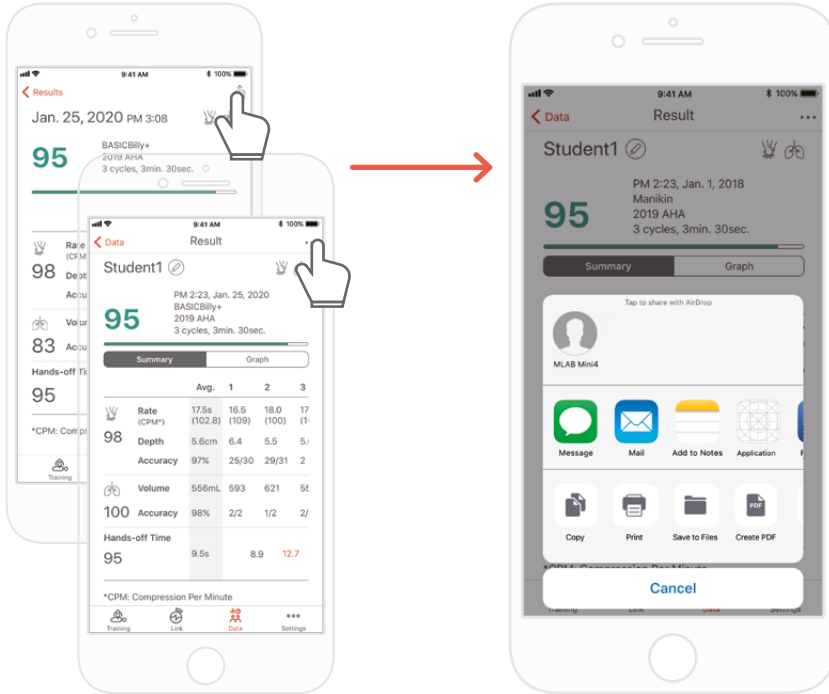

You can print the results or export PDF files to other apps by clicking the top right “Sharing” icon in the individual(detailed) results of the Student / Instructor app.



Result sheet (left) and certificate (right). Certificates can only be exported from the Instructor app.

BLS MANIKIN BASICBilly+

8.3. Renaming the manikin

CPR add-on kit Student app

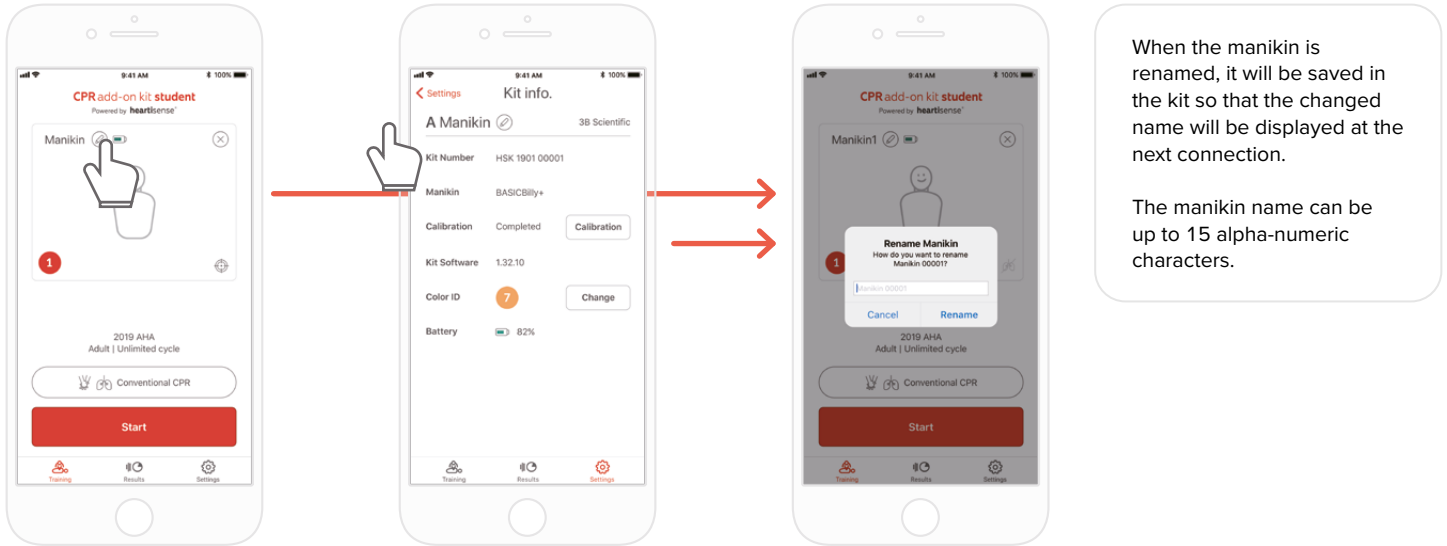

You can rename the manikin by pressing the pencil-shaped icon next to the manikin name.

CPR add-on kit Instructor app

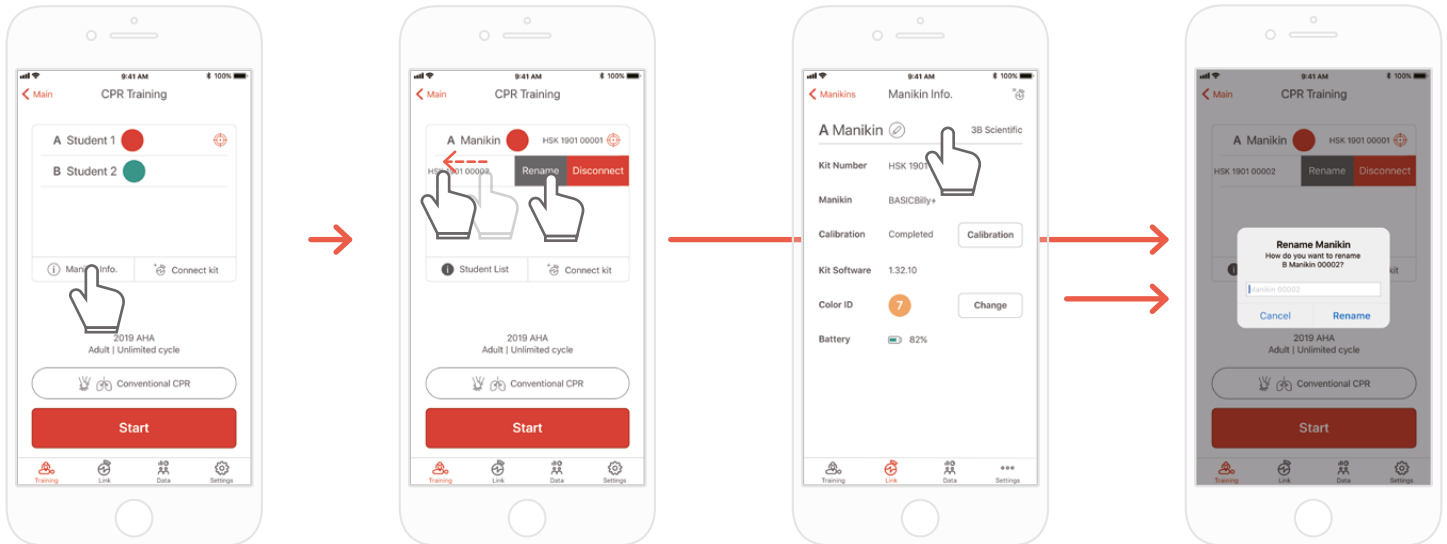

When you display the manikin list and push the slot whose name you intend to change to the left, the Rename button will be displayed. You can also rename it from the kit information on the Link tab.

BLS MANIKIN BASICBilly+

8.4. Renaming the student name (for Instructor app only)

Renaming the student for each slot

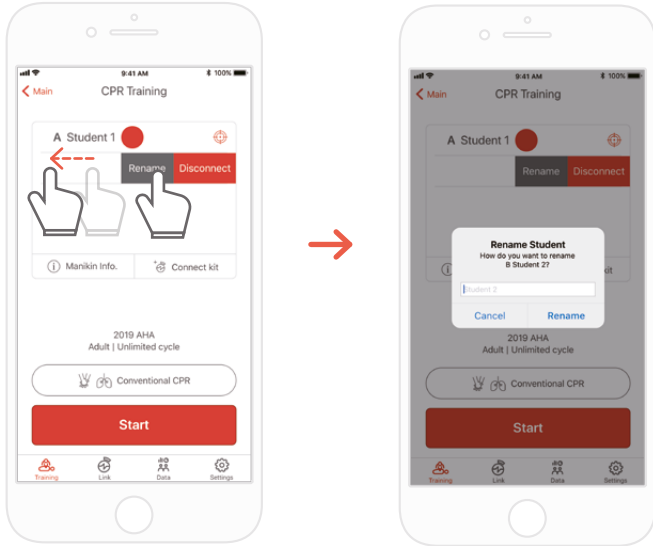

You can change the relevant student name by pushing the slot to the left.

*The changed student name is maintained while the relevant connection is maintained, and the result will be saved under the changed name

Renaming the student for the result

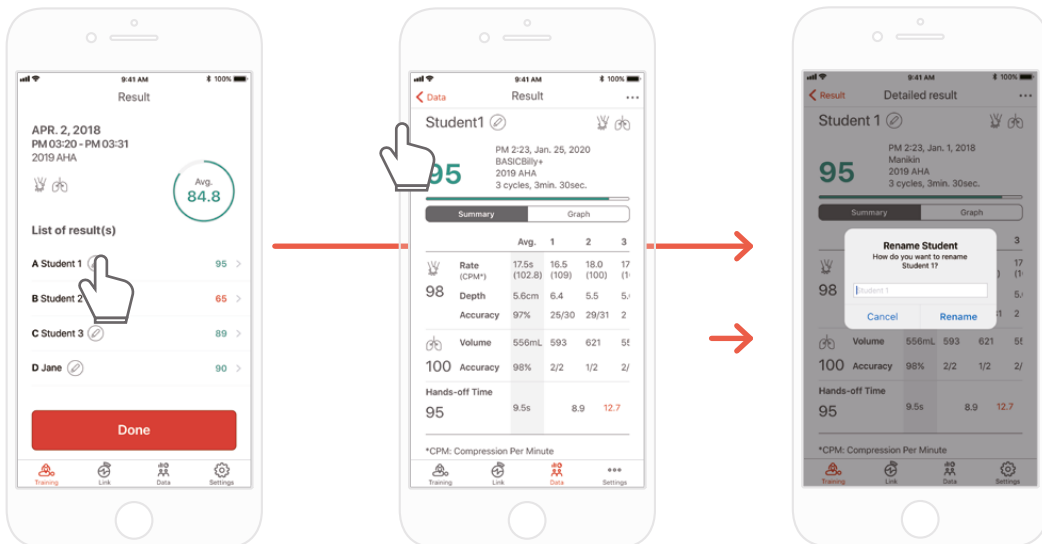

BLS MANIKIN BASICBilly+

8.5. Checking the connected kit information

CPR add-on kit Student

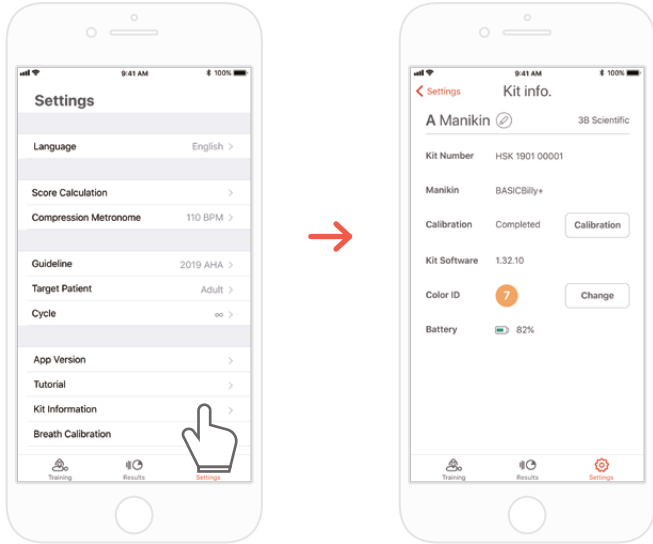

CPR add-on kit Instructor

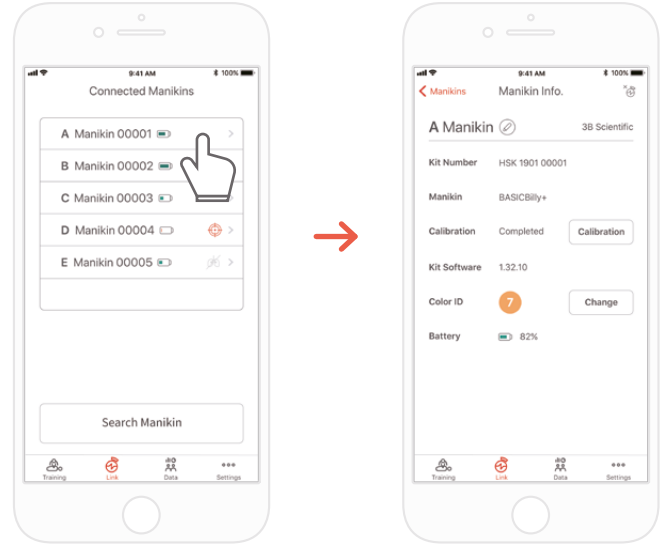

 The 'Settings' tab of the Student app → 'Kit Information'

 The 'Links' tab of the Instructor app → Select the manikin desired to check its detailed information

Re calibrate the breath module from the kit information screen (common for the Instructor and Student apps)

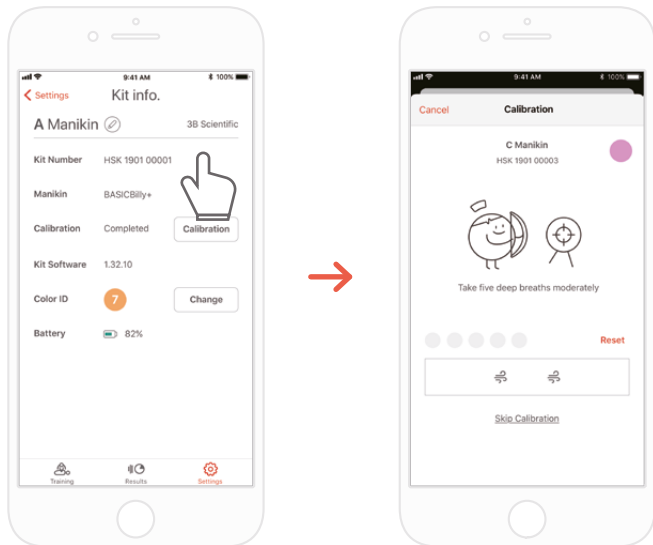

BLS MANIKIN BASICBilly+

8.6. Changing the settings

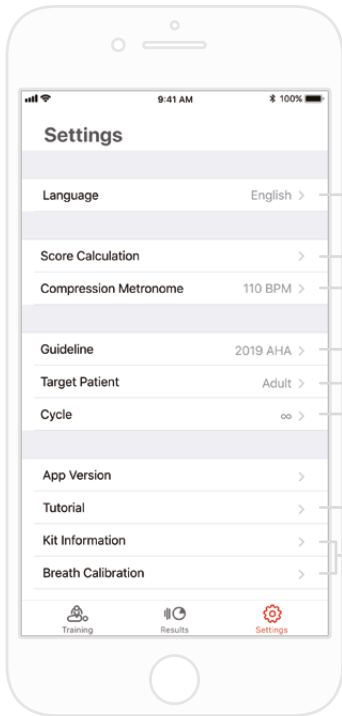

Change the language setting.

When English(US) is selected, the depth will be displayed in inches.

CPR parameters can be excluded or included with the compression and breath parameters in the score calculation. Compression and breath scoring ratio can be adjusted. (Default setting - 75:25)

You can adjust the rate of the metronome sound that guides the compression. (for the Student app only)

You can select the guideline and the rescuer type.

You can set the patient type.

It may not be supported depending on the manikin model.

When the number of cycle setted is reached, the evaluation will end automatically.

When ∞ (infinity) is set, the measurement will be taken until the user ends the measurement.

You can watch the tutorial video again.

You can modify the kit information and calibrate the breath sensor. (for the Student app only)

Checking the version of the current app

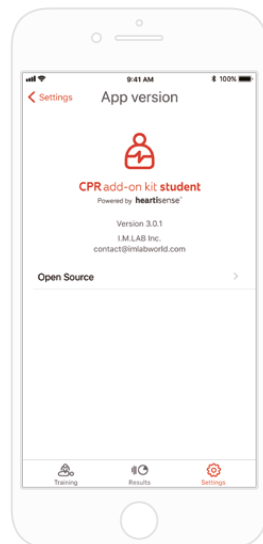
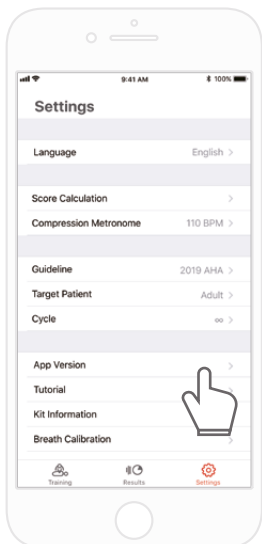

> 9. MAINTENANCE

9.1. Checking the remaining battery level of the kit

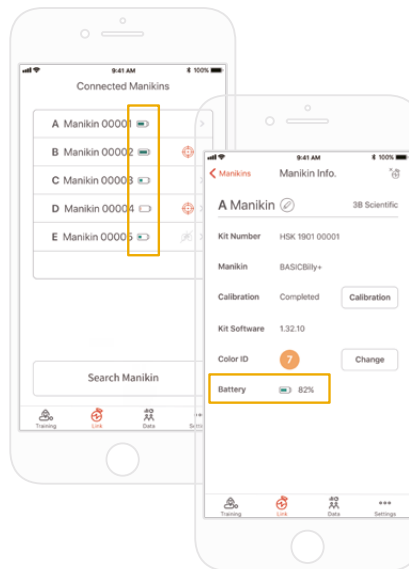
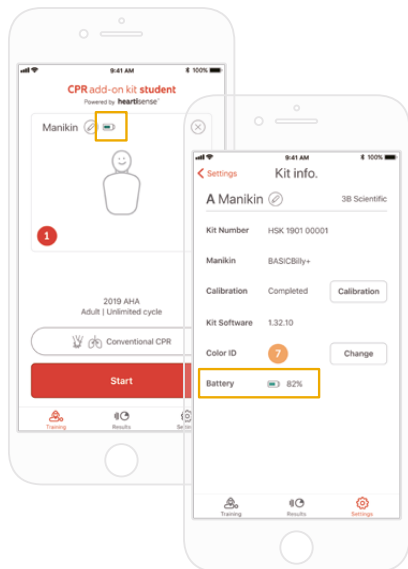

Check it from the kit information on the 'Training' main screen or 'Settings' of the Student app.



Check it from 'Link' or the Manikin Info of the Instructor app.

> 10. TROUBLESHOOTING

10.1. Frequently Asked Questions

Q. The app does not recognize the kit.

- A.**
- 1) Perform chest compression on the BASICBilly+ to 'wake-up' the kit. If beeping sound is not made, take out the batteries and put them back in again.
 - 2) If the beeping sound is still not made after taking out the batteries and putting them back in again, change the batteries.
 - 3) If the kit is still not searched and found the application after the 2 first troubleshooting action, please contact the customer service from 3BScientific.

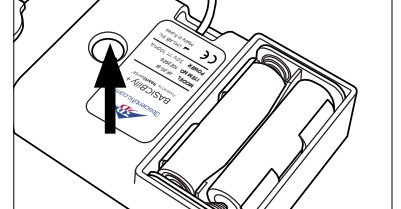

Q. The Upgrade kit's power seems to be on, but the application cannot search the kit.

- A.** If you're using 'HeartiSense' app not 'Add-on kit' app, the kit cannot be connected. Please search "Add-on kit" from the app store or Google store and download the correct app.



CPR add-on kit
Student/Instructor apps



HeartiSense
Student/Instructor apps

Q. The batteries are inserted correctly, but the kit does not wake up even after compression (Or, it does not make the beeping sound).

- A.**
- 1) Please make sure that batteries are properly inserted. If the ends of the batteries are not touching the electrodes, the power wouldn't turn on.
 - 2) Please replace the old batteries with new batteries.

Q. While using the app, the message "Low Battery" is shown.

- A.** Please replace the old batteries with the new batteries.

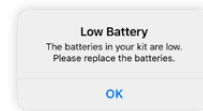

Q. When breath is delivered, manikin's chest rises (due to the air filled) but the app does not show any value.

- A.** Please check and make sure that the breath module is properly attached to the lung bag.

Q. Where can I check kit software(firmware) information?

- A.** For Student app, go to 'Settings' > 'Kit Information', then check 'Kit Software'.
For Instructor app, go to 'Link' tab, then choose the kit you wish to check the information for further details.
*Please refer to section 8.5.

Q. Where can I check app version?

- A.** Go to 'Settings' > 'App Version'.
*Please refer to section 8.6.

BLS MANIKIN BASIC*Billy*+

10.2. Troubleshooting

Symptom

While trying to connect with the kit, the message "Connection Failed" is shown.



Or the icon on the left is shown.

Even after being disconnected from the application, the kit repeatedly makes the beeping sound.

Breath module is properly connected but the value shown is not correct.

During CPR session, within 5 minutes and 5m distance range, the connection with the kit continues to be lost.

Cause

The breath module is not good to use and needs to be replaced.

It is possible that something is blocking the sensor part, causing wake-up function error.

The breath module is too old and needs to be replaced.

The saved breath calibration value might be wrong so that the appropriate breath volume cannot be shown.

The mobile device you're using is not compatible with the kit.

The kit software is outdated.

The connection might be lost if there is an obstacle between the kit and the user's mobile device.

Troubleshooting

The breath module has to be replaced, please contact the 3BScientific customer service.

Remove obstruction (kit module cable, object, etc) near the sensor part (the hole on the kit) from the kit.

The breath module has to be replaced, please contact 3BScientific customer service.

Open the 'Kit Information' screen, then press the 'Calibration' button to recalibrate the breath sensor.

Recommended technical specification for mobile devices:

- iOS
OS version equal to or above 11, iPhone 6 or later, iPod Touch 6th generation or later, iPad 5th generation or later, iPad mini 4 or later, iPad Air 2 or later are recommended.
- Android
Devices released after 2017 that support operating systems version 6.0 (Marshmallow) or later, and BLE 4.2 or later

* Some low-end models may experience connectivity issues even with BLE 4.2 or later

Refer to the section '8.5. Checking the kit information' and check 'Kit software'. Update is required if the firmware version is below 1.1.1. Please contact 3BScientific customer service.

Please make sure that there is no obstacle between the kit and the user's mobile device.

> 11. WARRANTY

1. Manufacturer offers a LIMITED WARRANTY against any defects in workmanship or materials under normal use for one (1) year from the date of purchase. Any component of the "BASIC*Billy*+ Upgrade Kit" which proves defective within the warranty period will be repaired, free of charge. The customer is responsible for shipping and handling fees to the place which manufacturer designates.
2. Customer must provide proof of the date of purchase, place of purchase and the purchase price in order to obtain service under this limited warranty. No agent, representative, dealer of Manufacturer has the authority to alter the obligations or limitations of this limited warranty.
3. CUSTOMER'S SOLE AND EXCLUSIVE REMEDY AGAINST MANUFACTURE SHALL BE FOR THE REPAIR OR REPLACEMENT OF DEFECTIVE GOODS AS PROVIDED HEREIN. Repair of any component of any "BASIC*Billy*+ Upgrade Kit" does not extend this limited warranty or begin a new limited warranty period.
4. Manufacturer reserves the right to refuse warranty service or replacement when product failure is due to abrasion, abnormal use, misuse, mishandling, misapplication, accident, neglect, improper installation, modification, use of unauthorized parts or attachments, adjustments or repair performed by anyone other than manufacturer or its authorized agent, or any causes other than defective workmanship or material. This limited warranty does not cover failure or damage resulting from unsuitable operating environments or storing environments or natural disasters or acts of God. MANUFACTURER SHALL NOT BE LIABLE FOR INCIDENTAL OR CONSEQUENTIAL DAMAGES ARISING OUT OF THE USE OF THE "BASIC*Billy*+ Upgrade Kit" OR THE BREACH OF THIS OR ANY OTHER EXPRESSED OR IMPLIED WARRANTY.