



## REFRIGERATORS FREEZERS

### *MODEL NOS.*

*Refrigerators: ADA404REF, BREF44*

*Freezers: ADA305AF, BREF45*

### *User Manual*

BEFORE USE, PLEASE READ AND FOLLOW ALL SAFETY RULES AND OPERATING INSTRUCTIONS.

*Write Serial Number (on lower left corner of  
inside cabinet) here:*

Serial No.: \_\_\_\_\_

# TABLE OF CONTENTS

<b>Refrigerator or Freezer Safety</b>	<b>3</b>
<b>Important Safeguards</b>	<b>3-4</b>
<b>Installation Instructions</b>	<b>5-7</b>
<i>Before Using your Refrigerator or Freezer</i>	5
<i>Installation of your Refrigerator or Freezer</i>	5
<i>Electrical Connection</i>	6
<i>Extension Cord</i>	6
<i>Reversing the Door Swing</i>	7
<i>Installing the Handle</i>	7
<b>Operating your Refrigerator or Freezer</b>	<b>8-12</b>
<i>Control Panel for Digital Thermostats</i>	8-10
<i>Controls for Dial Thermostats</i>	10
<i>Defrosting</i>	11
<i>Shelves</i>	11
<i>Door Lock</i>	12
<b>Care and Maintenance</b>	<b>13</b>
<i>Cleaning your Refrigerator or Freezer</i>	13
<i>Power Failure</i>	13
<i>Vacations</i>	13
<i>Moving your Refrigerator or Freezer</i>	13
<i>Energy-Saving Tips</i>	13
<b>Troubleshooting</b>	<b>14</b>
<b>Notes</b>	<b>15</b>
<b>Limited Warranty</b>	<b>16</b>

# REFRIGERATOR OR FREEZER SAFETY

Your safety and the safety of others are very important.

We have provided many important safety messages in this manual and on your appliance. Always read and obey all safety messages.



This is the Safety Alert Symbol. The symbol alerts you to potential hazards that can kill or injure you and others. All safety messages will follow the Safety Alert Symbol and either the word DANGER or WARNING.



DANGER means that failure to heed this safety statement may result in severe personal injury or death.



WARNING means that failure to heed this safety statement may result in extensive product damage, serious personal injury, or death.

All safety messages will alert you about the potential hazard, tell you how to reduce the chance of injury, and let you know what can happen if the instructions are not followed.

---

## IMPORTANT SAFEGUARDS



Before the refrigerator or freezer is used, it must be properly positioned and installed as described in this manual, so read the manual carefully. To reduce the risk of fire, electrical shock or injury when using the refrigerator or freezer, follow basic precautions, including the following:



- Plug into a grounded 3-prong outlet, do not remove grounding prong, do not use an adapter, and do not use an extension cord.
- Replace all panels before operating.
- It is recommended that a separate circuit serving only your refrigerator or freezer be provided. Use receptacles that cannot be turned off by a switch or pull chain.
- Never clean refrigerator or freezer parts with flammable fluids. These fumes can create a fire hazard or explosion. And do not store or use gasoline or other flammable vapors and liquids in the vicinity of this or any other refrigerator or freezer. The fumes can create a fire hazard or explosion.
- Do not connect or disconnect the electric plug when your hands are wet.
- Unplug the refrigerator or freezer or disconnect power before cleaning or servicing. Failure to do so can result in electrical shock or death.
- Do not attempt to repair or replace any part of your refrigerator or freezer unless it is specifically recommended in this manual. All other servicing should be referred to a qualified technician.
- This appliance is CFC- and HFC-free and contains small quantities of Isobutane (R600a) which is environmentally friendly, but flammable. It does not damage the ozone layer, nor does it increase the greenhouse effect. Care must be taken during transportation and setting up of the appliance that no parts of the cooling system are damaged. Leaking coolant can ignite and may damage the eyes.

- In the event of any damage:
  - Avoid open flames and anything that creates a spark,
  - Disconnect from the power supply,
  - Air the room in which the refrigerator or freezer is located for several minutes and
  - Contact the Service Department for advice.
- The more coolant there is in an appliance, the larger the room it should be installed in. In the event of a leakage, if the appliance is in a small room, there is the danger of combustible gases building up. For every ounce of coolant, at least 325 cubic feet of room space is required. The amount of coolant in the appliance is stated on the data plate inside the appliance. It is hazardous for anyone other than an Authorized Service Person to carry out servicing or repairs to this appliance.
- Take serious care when handling, moving and using the appliance to avoid either damaging the refrigerant tubing or increasing the risk of a leak.
- Replacing component parts and servicing shall be done by factory authorized service personnel, so as to minimize the risk of possible ignition due to incorrect parts or improper service.

## **WARNING**

### FOLLOW WARNING CALLOUTS BELOW ONLY WHEN APPLICABLE TO YOUR MODEL

- Use two or more people to move and install the appliance. Failure to do so can result in back or other injury.
- To ensure proper ventilation for your refrigerator or freezer, the front of the unit must be completely unobstructed. Choose a well-ventilated area with temperatures above 44°F (7°C) and below 90°F (32°C).
- The appliance should not be located next to ovens, grills or other sources of high heat.
- The appliance must be installed with all electrical, water and drain connections in accordance with state and local codes. A standard electrical supply (115 V AC only, 60 Hz), properly grounded in accordance with the National Electrical Code and local codes and ordinances, is required.
- Do not kink or pinch the power supply cord of the appliance.
- The size of the fuse (or circuit breaker) should be 15 amperes.
- It is important that the appliance be leveled in order to work properly. You may need to make several adjustments to level it.
- All installations must be in accordance with local plumbing code requirements.
- Make certain that the pipes are not pinched, kinked or damaged during installation.
- Check for leaks after connection.
- Never allow children to operate, play with or crawl inside the appliance.
- Do not use solvent-based cleaning agents or abrasives on the interior. These cleaners may damage or discolor the interior.
- Use this appliance only for its intended purpose as described in this *User Manual*.
- Keep fingers out of the “pinch point” areas. Clearances between the door and cabinet are necessarily small. Be careful closing the door when children are in the area.
- 

## **DANGER**

### ***Risk of child entrapment!***

Child entrapment and suffocation are not problems of the past. Junked or abandoned refrigerator or freezers are still dangerous, even if they will “just sit for a few days”.

*Before discarding your old refrigerator:*

- *Take off the doors*
- *Leave the shelves in place so that children may not easily climb inside.*

**- SAVE THESE INSTRUCTIONS -**

# INSTALLATION INSTRUCTIONS

## Before Using your Refrigerator or freezer

- Remove the exterior and interior packing.
- Before connecting the refrigerator or freezer to the power source, let it stand upright for approximately 2 hours. This will reduce the possibility of a malfunction in the cooling system from handling during transportation.
- Clean the interior surface with lukewarm water using a soft cloth.
- Install the handle on the door, if it is not already attached. (See page 8.)

## Installation of your Refrigerator or freezer

- The refrigerator or freezer is designed for built-in or recessed or free standing installation for indoor use.

**CAUTION:** *This refrigerator or freezer is designed for general purpose storage. If storing sensitive medicine or laboratory grade material, we recommend adding additional equipment for temperature stability and monitoring.*

- Place your refrigerator or freezer on a floor that is strong enough to support it when it is fully loaded. To level the unit, adjust the front leveling legs.
- For free standing installation, 5" (127mm) of space between the back and sides of the unit, and 4" (102mm) at the top, are suggested, which allows the proper air circulation to cool the compressor and condenser. Even for built-in installation, it is a must to keep ¼" (6.35mm) space on each side and at the top and 2" (51mm) at the rear. Take care that the air vent at the front of the refrigerator or freezer is never covered or blocked in any way.

**NOTE:** It is recommended that you do not install the refrigerator or freezer near an oven, radiator or other heating source. Direct sunlight may affect the acrylic coating and heat sources may increase electrical consumption. Don't install in a location where the temperature will fall below 44°F (7°C). For best performance, do not install the refrigerator or freezer behind a cabinet door or block the base grille.

- Avoid locating the unit in moist areas.
- Plug the refrigerator or freezer into an exclusive, properly grounded wall outlet.

## Electrical Connection



### **WARNING**

Improper use of the grounded plug can result in the risk of electrical shock. If the power cord is damaged, have it replaced by a qualified electrician or an authorized service center.

This refrigerator or freezer should be properly grounded for your safety. The power cord of this refrigerator or freezer is equipped with a three-prong plug which mates with standard three-prong wall outlets to minimize the possibility of electrical shock.

Do not under any circumstances cut or remove the third (ground) prong from the power cord supplied. For personal safety, this refrigerator or freezer must be properly grounded. Any questions concerning power and/or grounding should be directed toward a certified electrician or an authorized service center.

This refrigerator or freezer requires a standard 115/120 Volt AC ~60Hz three-prong grounded electrical outlet. Have the wall outlet and circuit checked by a qualified electrician to make sure the outlet is properly grounded. When a standard 2-prong wall outlet is encountered, it is your responsibility and obligation to have it replaced with a properly grounded 3-prong wall outlet.

To prevent accidental injury, the cord should be secured behind the refrigerator or freezer and not left exposed or dangling.

The refrigerator or freezer should always be plugged into its own individual electrical outlet which has a voltage rating that matches the rating label on the refrigerator or freezer. This provides the best performance and also prevents overloading house wiring circuits that could cause a fire hazard from overheating. Never unplug the refrigerator or freezer by pulling on the power cord. Always grip the plug firmly and pull straight out from the receptacle. Repair or replace immediately all power cords that have become frayed or otherwise damaged. Do not use a cord that shows cracks or abrasion damage along its length or at either end. When moving the refrigerator or freezer, be careful not to damage the power cord.

### **Extension Cord**

Because of potential safety hazards under certain conditions, it is strongly recommended that you do not use an extension cord with this refrigerator or freezer. However, if you must use an extension cord, it is absolutely necessary that it be a UL/CUL-Listed, 3-wire grounding type refrigerator or freezer extension cord having a grounding type plug and outlet and that the electrical rating of the cord be 115 volts and at least 10 amperes.

## Reversing the Door Swing

**NOTE:** Some door styles are not user-reversible. Consult [summitappliance.com](http://summitappliance.com) for details.

If you find the direction of opening the door of the refrigerator or freezer inconvenient, you can change it. Holes on the opposite side have already been prepared at the factory. To reverse your door, follow these instructions:

1. Take the upper hinge cover from the door, and remove the screws that hold the top hinge.
2. Lift the hinge straight up to free the hinge pin from the socket in the top of the door.
3. Lift the door up and away to free its bottom socket from the hinge pin.
4. Remove the screws from the bottom hinge.
5. Remove the decorative caps from the opposite side and plug the holes from the original side with the decorative caps.

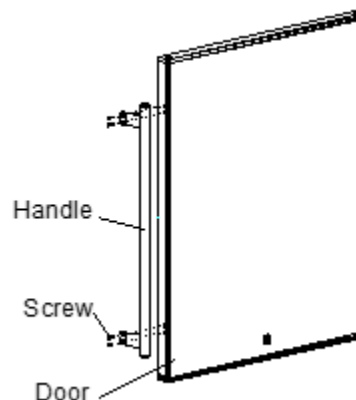

**NOTE:** If the hinge pin attached to the bottom hinge cannot be removed and reattached in the left hinge hole, use the hinge provided in the plastic bag where this *User Manual* was found.

6. Install the bottom hinge on the opposite side and tighten the screws. Use any lock washers or nuts, if they were used the original installation.
7. On the bottom of the door, unscrew and remove the white hinge cushion. Flip the cushion 180° and install on the opposite side of the door.
8. Replace the door onto the hinge pin on the bottom hinge. Place the top hinge pin into the door. Insert screws into the top hinge. Replace the upper hinge cover.
9. Install the decorative caps into the hinge holes on the top of the unit.

### **To switch the door handle:**

1. Remove the gasket from the inside of the door.
2. There are two screws and two washers holding the door handle to the door. Unscrew these and remove the door handle.
3. On the opposite side of the door, unscrew the screws holding the handle covers in place. Save these for later use.
4. Replace the washers and screws into the track on the opposite side of the door, and then attach the door handle.
5. Insert the screws for the handle hole covers, and while holding them in place, reinstall the handle hole covers. They will thread onto the screws.

### **Installing the Handle**

This refrigerator or freezer includes a handle that is not required to operate the unit. To install the handle, follow the instructions below:

1. Use a screwdriver to remove the screws on the side of door where the handle is to be installed.
2. Align the handle with the screws removed in step # 1. Tighten the screws using a Phillips head screwdriver until the handle is both flush and secured tightly against the door side. (DO NOT over-tighten as this will cause damage to the door surface.)

# OPERATING YOUR REFRIGERATOR OR FREEZER





It is recommended you install the refrigerator or freezer in a place where the ambient temperature is between 44° and 90°F (7° to 32°C). If the ambient temperature is above or below the recommended temperatures, the performance of the unit may be affected. For example, placing your unit in extremely cold or hot conditions may cause interior temperatures to fluctuate. The operating temperature range may not be reached.

**NOTE:** If the door of the unit is left open for more than five seconds, an alarm will sound. The alarm will stop once the door is closed.

## Control Panel for Digital Thermostats

Refrigerators and freezers include a digital thermostat located in the kick plate of your unit.

### Indicator Symbol Table:

Indicator	Symbol	Status	Meaning
Setting	Set	ON	Set parameters
		OFF	Temperature measuring and controlling
Cooling		ON	Cooling active
		OFF	Cooling inactive
		Flash	Cooling delays
Defrost		ON	Defrost active
		OFF	Defrost inactive
Fan		ON	Fan active
		OFF	Fan inactive
Dripping	drip	ON	Dripping active
		OFF	Dripping inactive
Door signal		ON	Door is open.
		OFF	Door is closed.

- Press and hold the SET and the LIGHT keys for three seconds to turn the unit on/off.



- To adjust the temperature, press and hold the SET key for 3 seconds. When the display shows **St**, press SET. You can raise the temperature by pressing the LIGHT key or lower it by pressing the MENU ADJUST key, shown below. Press the  key, or press no key for 30 seconds, to exit. The temperature set-point will be saved automatically.



- Press the ❄️ key to view the temperature.
- Press and hold the ☀️ and 🌙 keys for three second to change the temperature display between °C and °F.
- Press the ☀️ key to turn the light on or off, if your unit has an internal light.

**NOTE:** When you use the unit for the first time or restart the unit after it has been shut off for a long time, there could be a few degrees variance between the temperature you select and the one indicated on the LED readout. This is normal and is due to the length of the activation time. There should not be a problem once the unit has been running for a few hours.

### Setting Parameters:

Several temperature parameter settings can be adjusted from the defaults, if you choose to do so. To adjust these parameters:

1. Press and hold the SET key for 3 second.
2. When the panel displays **St**, press the LIGHT key, and the panel will display **Po**.
3. Press the SET key, and 00 will display.
4. Enter the administrator password (55).
5. Press the SET key, and the panel will display **Po**.
6. Press the ❄️ and 🌙 keys to select the appropriate parameter (**do2**, **A5**, **A6**, etc.).
7. After selecting a parameter, press the SET key to set its value. Use the ❄️ and 🌙 keys to adjust the value, the press the SET key to return to the menu.
8. Press the ❄️ key, or press no key for 30 seconds, to exit. The temperature set-point will be saved automatically.

### Parameter Table:

ADA404REF, BREF44 (Refrigerator models)	Temperature Range: 2°C to 8°C (preset at 4°C) High Temperature Alarm: Preset at 8°C Low Temperature Alarm: Preset at 2°C Door Open Alarm: Set at 60 seconds
ADA305AF, BREF45 (Freezer models)	Temperature Range: -30°C to -10°C (preset at -25°C) High Temperature Alarm: Preset at -15°C Low Temperature Alarm: Preset at -35°C Door Open Alarm: Set at 60 seconds



### Door Open Alarm:

Your unit will sound an alarm when the door is open for longer than five seconds. To disable this:

1. Follow the Setting Parameters instructions on page 8.
2. Find parameter **do2**.
3. The default for the unit is set at **1** (Enabled).
4. To disable the alarm, set the parameter to **0** (Disabled).
5. Press the  key, or press no key for 30 seconds, to exit. The temperature set-point will be saved automatically.



### **Low Temperature Alarm:**

To set a low temperature alarm:

1. Follow the Setting Parameters instructions on page 8.
2. Find parameter **A5**.
3. Use the Use the  and  keys to adjust the temperature.
4. Press the  key, or press no key for 30 seconds, to exit. The temperature set-point will be saved automatically.

### **High Temperature Alarm:**

To set a high temperature alarm:

5. Follow the Setting Parameters instructions on page 8.
6. Find parameter **A6**.
7. Use the Use the  and  keys to adjust the temperature.
8. Press the  key, or press no key for 30 seconds, to exit. The temperature set-point will be saved automatically.

## **Alarms**

Various alarms will sound under certain conditions if the unit's buzzer is enabled. Below is a table listing the unit's alarm codes and causes:

<b>Alarm Code</b>	<b>Causes</b>
E1	Cabinet temperature sensor fails.
E2	Evaporator sensor fails.
E3	Condenser sensor fails.
cH	High condenser temperature alarm
rH	High cabinet temperature alarm
rL	Low cabinet temperature alarm

## **Controls for Dial Thermostats**

- Some units in this collection include a dial thermostat located inside the unit on the upper-right side wall.
- Turn the knob clockwise from the **0 (OFF)** position toward the higher numbers for colder temperatures. Higher settings on the dial (higher numbers) mean lower temperatures (colder) in the unit.
- Changes in the ambient temperature affect temperature in the unit, so choose an appropriate setting of the thermostat dial, depending on ambient conditions.

## **Defrosting**

Refrigerators in this series defrost automatically in normal operating conditions. The evaporator

behind the rear wall of the unit defrosts automatically. The condensate collects in the drainage channel behind the rear wall of the unit, and flows through the drainage hole into the drip tray by the compressor where it evaporates.

However, frost may accumulate on the evaporator if the unit is repeatedly opened in a high heat or high humidity location. If this frost pattern does not clear within 24 hours, your unit will require manual defrosting.

**Freezer models and the freezer compartment of refrigerator-freezers require manual defrosting.** For the most efficient operation and minimum energy consumption, defrost the freezer when the frost on the freezer walls is excessive or  $\frac{1}{4}$  to  $\frac{1}{2}$ " thick.

**CAUTION:** *Never use boiling water because it may damage the plastic parts. In addition, never use a sharp or metallic instrument to remove frost, as it may damage the cooling coils and will void your warranty. We recommend using a plastic scraper.*

### To defrost:

1. Remove the frozen items from the freezer and place it in another cooling device
2. Turn the thermostat off and unplug your freezer, leaving the door open to help speed up the defrosting process
3. Use a sponge or toweling to remove water and melting ice from the freezer floor. Pouring warm (not boiling) water on the ice/frost may also help speed the defrosting process.
4. Clean and thoroughly dry the freezer interior
5. Close the door and plug the freezer in, resetting the thermostat to the desired setting
6. Allow several hours for the cabinet to reach the proper storage temperature

### Shelves

To prevent damaging the door gasket, make sure to have the door all the way open when pulling the shelves out of the rail compartment.

- Any of the shelves can be removed to store larger items.
- When removing the shelf from the rail compartment, make sure to remove all items first. Then move the shelf to the position where the notch of the shelf is exactly under the plastic post and lift the shelf. In order to replace the shelf, repeat steps described above in reverse.

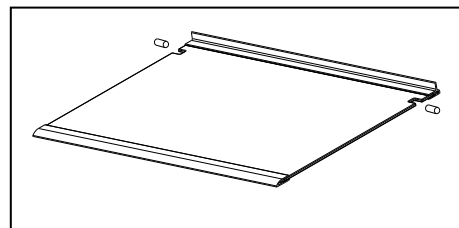

### Door Lock

Your unit is provided with a lock and key combination.

The keys are located inside the plastic bag that contains the *User Manual*. Insert the key into the lock and turn it counter-clockwise to unlock the door. To lock the door, do the reverse operation, making sure the metal pin is engaged completely. Remove the key and put it in a secure place for safekeeping.

#### **CALIFORNIA CARB/SNAP DISCLOSURE**

**This product uses eco-friendly hydrocarbon refrigerant and fully complies with California CARB regulations.**

However, we are required by California Law to provide the following disclosure statement in every product sold in California.

*"This equipment is prohibited from use in California with any refrigerants on the 'List of Prohibited Substances' for that specific end-use, in accordance with California Code of Regulations, title 17, section 95374. This disclosure statement has been reviewed and approved by Felix Storch, Inc. and Felix Storch, Inc. attests, under penalty of perjury, that these statements are true and accurate."*

This product does **not** use any refrigerants on the 'List of Prohibited Substances'"

# CARE AND MAINTENANCE

## Cleaning your Refrigerator or Freezer

- Turn off the power, unplug the refrigerator or freezer, and remove all items, including shelves.
- Wash the inside surfaces with a solution of warm water and baking soda (about 2 tablespoons of baking soda to a quart of water).
- Wash the shelves with a mild detergent solution.
- Wring excess water out of the sponge or cloth when cleaning the area where the controls are located, or any electrical parts.
- Wash the outside cabinet with warm water and mild liquid detergent. Rinse well and wipe dry with a clean soft cloth.

**CAUTION:** *Failure to unplug the refrigerator or freezer during cleaning could result in electrical shock or other personal injury.*

## Power Failure

Most power failures are corrected within a few hours and should not affect the temperature of your refrigerator or freezer if you minimize the number of times the door is opened. If the power is going to be off for a longer period of time, you need to take the proper steps to protect the contents.

## Vacations

- **Short vacations:** Leave the refrigerator or freezer operating during vacations of less than three weeks.
- **Long vacations:** If the refrigerator or freezer will not be used for several months, remove all items and turn off the refrigerator or freezer. Clean and dry the interior thoroughly. To prevent odor and mold growth, leave the door open slightly, blocking it open if necessary.

## Moving your Refrigerator or Freezer

1. Remove all items.
2. Securely tape down all loose items (shelves) inside your refrigerator or freezer.
3. Turn the adjustable legs up to the base to avoid damage.
4. Tape the door shut.
5. Be sure the refrigerator or freezer stays secure in the upright position during transportation. Also, protect the outside of the refrigerator or freezer with a blanket or similar item.

## Energy-Saving Tips

- The refrigerator or freezer should be located in the coolest area of the room or outdoor location, away from heat-producing appliances and out of direct sunlight.
- Ensure that the unit is adequately ventilated. Never cover air vents.
- Do not keep the door open any longer than necessary.
- Unit shelves and storage bins should not be lined with aluminum foil, wax paper, or paper toweling. Liners interfere with cold air circulation, making the unit less efficient.

# TROUBLESHOOTING

You can solve many common problems easily, saving you the cost of a possible service call. Try the suggestions below to see if you can solve the problem before calling the servicer.

## Troubleshooting Guide

PROBLEM	POSSIBLE CAUSE	REMEDY
The refrigerator or freezer does not operate.	<ul style="list-style-type: none"> <li>• The refrigerator or freezer is not connected to a power supply.</li> <li>• The refrigerator or freezer is turned off.</li> <li>• Tripped circuit breaker or a blown fuse.</li> </ul>	<ul style="list-style-type: none"> <li>• Connect the refrigerator or freezer.</li> <li>• Switch on the refrigerator or freezer.</li> <li>• Switch on circuit breaker or replace fuse.</li> </ul>
The refrigerator or freezer is not cold enough.	<ul style="list-style-type: none"> <li>• The temperature is not set correctly.</li> <li>• The ambient temperature could require a lower temperature setting.</li> <li>• The door was opened too often.</li> <li>• The door was not closed completely.</li> <li>• Door is not hermetically sealed.</li> <li>• The condenser is too dirty.</li> <li>• The ventilation opening is blocked or too dusty.</li> </ul>	<ul style="list-style-type: none"> <li>• Check the set temperature.</li> <li>• Set a lower temperature.</li> <li>• Do not open the door more often than necessary.</li> <li>• Close door properly.</li> <li>• Check the door seal and clean or replace.</li> <li>• Clean the condenser when necessary.</li> <li>• Clear the obstructions and clean off the dust.</li> </ul>
The refrigerator or freezer turns itself on and off frequently.	<ul style="list-style-type: none"> <li>• The room temperature is higher than average.</li> <li>• The door is open too often.</li> <li>• The door is not closed completely.</li> <li>• The door gasket does not seal properly.</li> </ul>	<ul style="list-style-type: none"> <li>• Put the refrigerator or freezer in a cooler place.</li> <li>• Leave the refrigerator or freezer to work for a while until the set temperature has been reached.</li> <li>• Do not open the door more often than necessary.</li> <li>• Close door properly.</li> <li>• Check the door seal and clean or replace.</li> </ul>
Vibrations	<ul style="list-style-type: none"> <li>• The refrigerator or freezer is not properly leveled.</li> </ul>	<ul style="list-style-type: none"> <li>• Level the refrigerator or freezer with the adjustable feet.</li> </ul>
The refrigerator or freezer seems to make too much noise.	The rattling noise may come from the flow of the refrigerant, which is normal. As each cycle ends, you may hear gurgling sounds caused by the flow of refrigerant in your refrigerator or freezer. If temperature fluctuations occur, the contraction and expansion of the inner walls may cause popping and crackling noises.	
	<ul style="list-style-type: none"> <li>• The refrigerator or freezer is not properly level.</li> </ul>	<ul style="list-style-type: none"> <li>• Level the refrigerator or freezer with the adjustable feet.</li> </ul>
The door will not close properly.	<ul style="list-style-type: none"> <li>• The refrigerator or freezer is not properly level.</li> <li>• The door was reversed and not properly installed.</li> <li>• The gasket is dirty.</li> <li>• The shelves are out of position.</li> </ul>	<ul style="list-style-type: none"> <li>• Level the refrigerator or freezer with the adjustable feet.</li> <li>• Check the door hinge and reassemble correctly.</li> <li>• Clean the door gasket.</li> <li>• Check the shelves and refit correctly.</li> </ul>

If you've checked the table above and find that you still need help with your refrigerator or freezer, call our Customer Service facility at **800-932-4267** between 9:00AM and 5:00PM ET. We will do our best to answer your questions.

# NOTES

# LIMITED WARRANTY

## ONE-YEAR LIMITED WARRANTY

Within the 48 contiguous United States, for one year from the date of purchase, when this refrigerator or freezer is operated and maintained according to instructions attached to or furnished with the product, warrantor will pay for factory-specified parts and repair labor to correct defects in materials or workmanship. Service must be provided by a designated service company. Outside the 48 states, all parts are warranted for one year from manufacturing defects. Plastic parts, shelves and cabinets are warranted to be manufactured to commercially acceptable standards, and are not covered from damage during handling or breakage.

## 5-YEAR COMPRESSOR WARRANTY

1. The compressor is covered for 5 years.
2. Replacement does not include labor.

### *ITEMS WARRANTOR WILL NOT PAY FOR:*

1. Service calls to correct the installation of your refrigerator or freezer, to instruct you how to use your refrigerator or freezer, to replace or repair fuses or to correct wiring or plumbing.
2. Service calls to repair or replace refrigerator or freezer light bulbs or broken shelves. Consumable parts (such as filters) are excluded from warranty coverage.
3. Damage resulting from accident, alteration, misuse, abuse, fire, flood, acts of God, improper installation, installation not in accordance with electrical or plumbing codes, or use of products not approved by warrantor.
4. Replacement parts or repair labor costs for units operated outside the United States.
5. Repairs to parts or systems resulting from unauthorized modifications made to the refrigerator or freezer.
6. The removal and reinstallation of your refrigerator or freezer if it is installed in an inaccessible location or is not installed in accordance with published installation instructions.

## DISCLAIMER OF IMPLIED WARRANTIES; LIMITATION OF REMEDIES

CUSTOMER'S SOLE AND EXCLUSIVE REMEDY UNDER THIS LIMITED WARRANTY SHALL BE PRODUCT REPAIRS PROVIDED HEREIN. IMPLIED WARRANTIES, INCLUDING WARRANTIES OF MERCHANTABILITY OR FITNESS FOR A PARTICULAR PURPOSE, ARE LIMITED TO ONE YEAR. WARRANTOR SHALL NOT BE LIABLE FOR INCIDENTAL OR CONSEQUENTIAL DAMAGES. SOME STATES DO NOT ALLOW THE EXCLUSION OR LIMITATION OF INCIDENTAL OR CONSEQUENTIAL DAMAGES, OR LIMITATIONS ON THE DURATION OF IMPLIED WARRANTIES OF MERCHANTABILITY OR FITNESS, SO THESE EXCLUSIONS OR LIMITATIONS MAY NOT APPLY TO YOU. THIS WARRANTY GIVES YOU SPECIFIC LEGAL RIGHTS AND YOU MAY ALSO HAVE OTHER RIGHTS, WHICH VARY FROM STATE TO STATE.

**WARNING:** This product can expose you to chemicals including Nickel (Metallic) which is known to the State of California to cause cancer.



For more information go to [www.P65Warnings.ca.gov](http://www.P65Warnings.ca.gov)

Note: Nickel is a component in all stainless steel and some other metal components.

# accucold