

DATA LOGGER Model DL-SA11

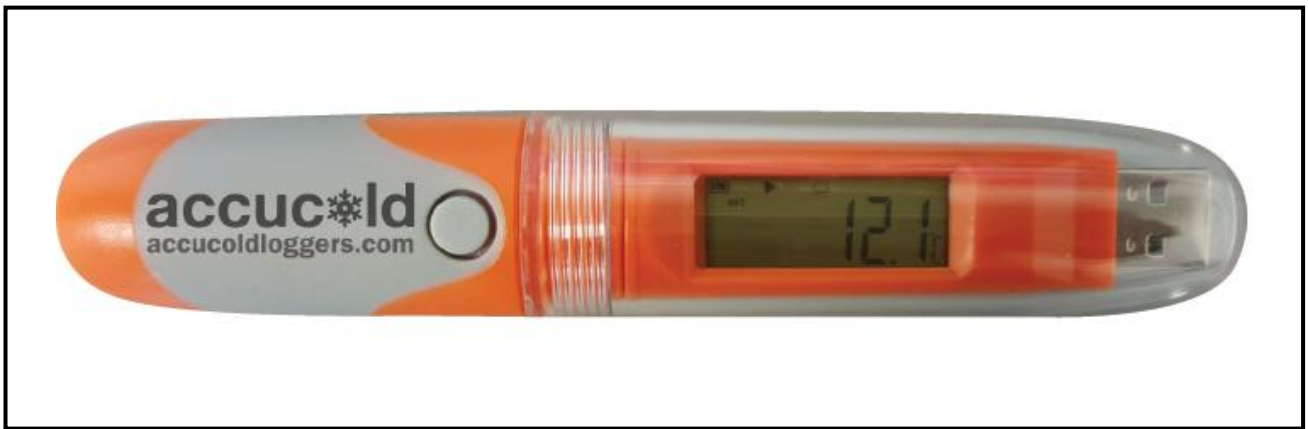

User's Manual

Product Overview

This data logger is used mainly to record the temperature of food, pharmaceuticals, chemicals, etc., during storage and transportation. It is especially applicable to container transportation of temperature-sensitive goods by sea, air and road for large export-oriented enterprises and global chain enterprises.

Specifications

Size (length x diameter): 131 x 24 mm (5.16" x 0.95")

Technical parameters:

Temperature measuring range: -30°C to 70°C

Resolution: 0.1°C

Sensor: Built-in NTC thermistor

Temperature accuracy: $\pm 0.5^{\circ}\text{C}$ (-20°C to 40°C); $\pm 1^{\circ}\text{C}$ (other ranges)

Record capacity: 32,000 points (MAX)

Alarm type: continuous, cumulative

Alarm setting: no alarm, upper/lower limit alarm, multiple alarms

Record interval: 10 sec to 24 hour continuously set

Data interface: USB

Report type: Excel and AI/PDF

Power supply: single-use lithium battery 3.6V (replaceable)

Battery life: at least 12 months at 25°C with 15 min record interval

In the package

- ✓ DL-SA11 temperature data logger
- ✓ User's manual

Using the data logger

Download the data management software from the link below:

<http://accucoldloggers.com/dlsa11>

Data management software can be downloaded from the software platform by clicking the help button.



Install the software first. Insert the data logger into the computer's USB port and install the drive software according to the prompt information. Open the software; the data logger will automatically upload information after connecting to the computer. View information and exit the interface.

Note that the software installation has added an icon to your desktop. To access to the program, double-click on the icon.

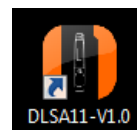

Configure parameters

Refer to the data management software instructions for details (pages 8 –14)

Caution! Make sure you have saved selected parameters.

Default Settings		Other settings	
Logging interval	5 minutes	0-11 hours; 0-59 minutes; 0-50 seconds	
Stop mode:	Software	Manual stop (see pp. 3-4)	
Start Mode:	Instant on	Manual and timing start (pg. 3)	
Temp. Unit	°C	°F	
Buffer Ring:	Disabled	Enabled	
Alarm Settings	H1 (high alarm) =	10 °C	
	L1 (low alarm) =	2 °C	User defined
	Alarm Mode:	Single	Cumulative

Start the data logger

There are three modes to start the logger – instant-on, manual start, and timing start.

1. **Instant-on:** After parameter configuration, the data logger starts recording immediately when it is disconnected from the USB.
2. **Manual start:** After parameter configuration, press and hold the button for 5 seconds to start the data logger. In this mode, it has a start delay function. If this function is enabled, the data logger will not record data immediately after start-up but start recording after the set delay time elapses.
3. **Timing start:** After parameter configuration and disconnection from USB, the data logger starts recording when it reaches the set time.

View data instantly

If you need to view simple statistical information, you may directly press the button to turn the page and check. The LCD screen can display MKT, average value, Max value and Min value. Mean Kinetic Temperature (MKT) is a simplified way of expressing the overall effect of temperature fluctuations during storage or shipment of perishable goods.

If you need detailed information, please connect the data logger to the computer's USB. After about 3 minutes, the data will be saved. You can open it as an Excel, AI or PDF report.

Moreover, you can connect the data logger to a computer and analyze the data using the data management software.

Stop the data logger

There are several modes to stop it – manual stop, stop via software, over-Max-record-capacity stop (enable/disable manual stop).

1. **Manual stop:** When the data logger is recording in this mode, you may press and hold the button for 5 seconds to stop it.
2. **Stop via software:** You can stop the data logger via software selecting the *Stop recording* option on the software platform.
If the record capacity reaches the Max value (32,000 points)



by

points)

and the data logger is not stopped manually, the data logger will save the data by overwriting the initial data. (It keeps the statistical information of the whole transportation process.)

NOTE: When the record capacity exceeds the Max capacity (32,000 points) in the manual mode, the data logger can continue recording the temperature state of the whole transportation process but only keep the details of the last 32,000 points. Please use the “manual stop” mode with caution if you have a need to trace back the details of the whole process.

3. Over-Max-record-capacity stop (enable manual stop): In this mode, you can stop the data logger by hand or via software, or it will stop automatically when the record data reaches the Max capacity (32,000 points).

Over-Max-record-capacity stop (disable manual stop): In this mode, it will stop automatically when the record data reaches the Max capacity (32,000 points), or you can stop it via software.

View data

Connect the data logger to the computer via USB and then view the data.

View report via the data management software: Open the software and import the data as Excel, Adobe Illustrator Artwork (AI) or PDF report. The software will display the configuration information and recorded data.

Display menu instructions

Different screens are displayed when the unit is running. Below are various modes of operation of the data logger.

Menu 1: Start delay time or the remaining time of timing start (Hr: Min. Sec). See Figures 1 and 2. (This page is displayed only in start delay or timing start status.)

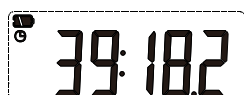

Fig.1: Start delay time



Fig.2: Timing start delay (▶ flashing)

Menu 2: Current temperature. See Fig. 3, 4 (Static ▶ indicates it is recording.)

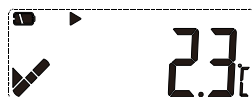

Fig.3 Current temperature (No alarm occurred)



Fig.4 Current temperature (Alarmed)

Menu 3: Current record points. See Fig.5 (Static □ indicates the current record points exceed the Max capacity and the data logger is overwriting initial data.)



Fig.5 Current record points

Menu 4: Current record interval. (e.g., the digit N following the decimal point represents N*10 sec. Fig.6 shows the record interval is set to 12 min 50 sec.)



Fig.6 Record interval

Menu 5: MKT value.



Fig.7

Static ■ indicates it stopped recording

Menu 6: Average temperature value.

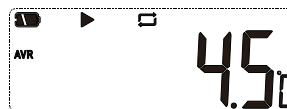

Fig.8

Menu 7: Max temperature value.

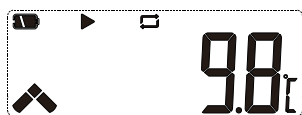

Fig.9

Menu 8: Min temperature value.

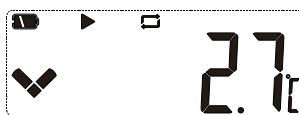

Fig.10

Menu 9, 10, 11: Set upper limit of temperature. See Fig.11, 12, 13



Fig.11 Upper limit 3



Fig.12 Upper limit 2

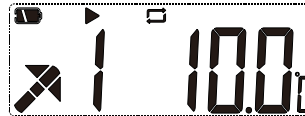

Fig.13 Upper limit 1

Menu 12, 13: Set lower limit of temperature. See Fig.14, 15

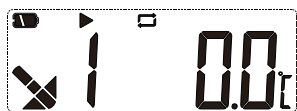

Fig.14 Lower limit 1

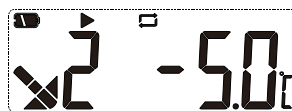

Fig.15 Lower limit 2

Other status:



Fig.16 Deleting data



Fig.17 Recovering data (Power on)

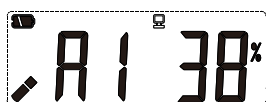

Fig.18 Generating report



Fig.19 USB connection

Content of exported report

The report varies based on the set alarm types.

When unit is set to “no alarm”, there is no alarm info on the top right corner of the first page or color mark among data.

When it is set to “alarm”, relative alarm info appears in the alarm info column based on the selected alarms. Over high temperature data is in red. Below low temperature data is in blue. Normal data is in black. If alarm cases occur, they will be marked as alarm status on top right corner of the first page; otherwise, it is in normal status.

Finish viewing

Exit the data logger after viewing the report.

Product diagram

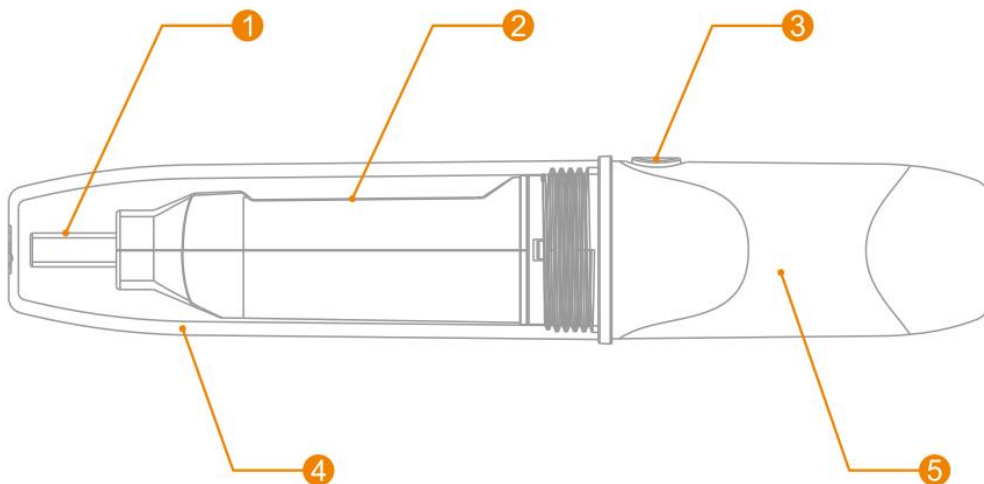

1	USB	4	Transparent cap
2	LCD screen	5	Battery compartment
3	Button		

Replacing the battery

PLEASE NOTE

Before replacing the battery you must first shut down the data logger. If not, when restarting the logger, the time will be incorrect.

Step 1. Rotate the transparent cap and remove it in the direction shown in Fig. 20.

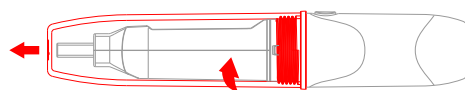

Fig.20

Step 2. Press the snap to remove the compartment. See Fig. 21.

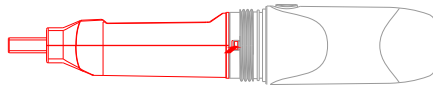

Fig.21

Step 3. Remove the battery compartment. See Fig. 22.

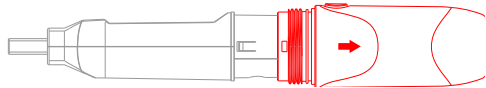

Fig.22

Step 4. Remove the old battery and Install the new one. See Fig. 23.

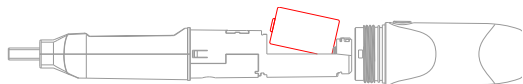

Fig.23

Step 5. Adjust the button and the internal light pipe to the same side; snap the compartment shut. See Fig. 24.

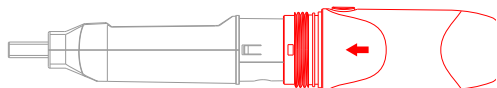

Fig.24

Step 6. To re-install the transparent cap, rotate it in the direction shown in Fig. 25.

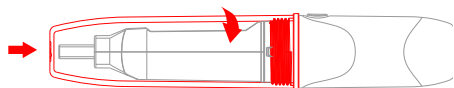

Fig.25

Data Management Software Instructions

Data Management Software can upload all recorded data to a computer and systematically analyze, collect and manage data.





1. Installation environment

Hardware environment :	Operation system:
CPU : above PII600MHZ	Windows XP (32bit、64bit, Windows Vista (32bit、64bit, Win7 (32bit、64bit) , Windows8(x86/x64)
Hard disk : above 40G	
Memory : above 512M	

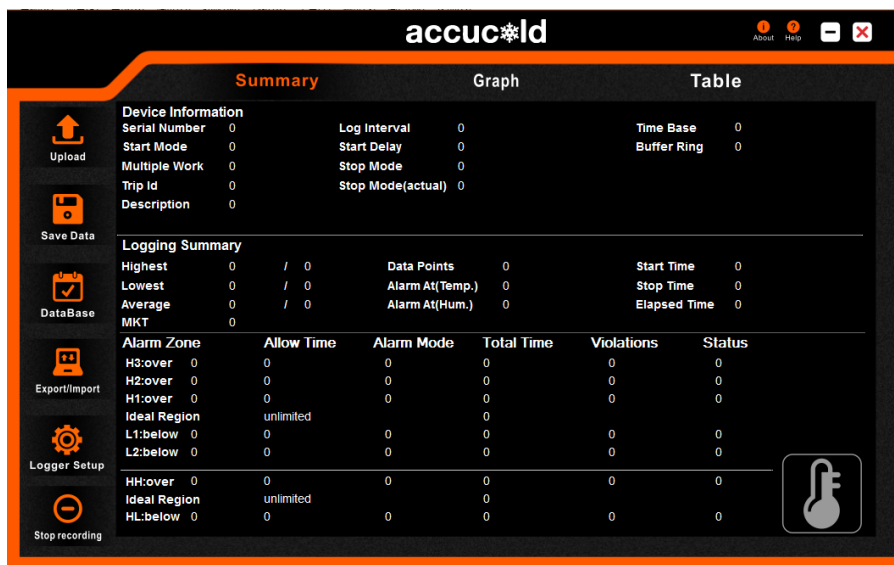
2. Main functions

2.1 : Main interface



Tool buttons:	Function
	Download recording data from logger
	Manually save data: if current data is not saved into database, then press this button to save data. For first time recording data, the system will automatically save the data and display the prompt of auto data saving. If new data is recorded and logger is inserted into computer once more, user needs to save the data manually by clicking the button, and it will display a dialog box to save the data.
	Database query interface displays all saved data information
	Export data in the format of AI, EXCEL or ELT
	Logger parameter setting

Parameter information:

Serial Number—Data logger ID	Stop Time—Stop time
Log Interval—Record interval	Data points—Total record points
Time Base—Time Zone	Elapsed time—Total record time
Start Mode—Logger start mode	MKT—Mean kinetic temperature
Start Delay—Logger start delay time	Over—Alarm upper limit
Buffer Ring—Buffer Ring	Below—Alarm lower limit
Trip ID—Trip ID number	Allow Time—Alarm delay time
Description—Trip description	Total time—Accumulated alarm time
Highest —Max. Temperature	Violations—Times alarm occurs
Lowest —Min. Temperature	Status —Logger alarm status
Average —Average Temperature	RH% - Relative Humidity
Stop Mode—Stop mode Set	Status —Logger alarm status
Stop mode (actual)—Actual stop mode	T ---Temperature
Start Time—Start time	RH% - Relative Humidity
Multiple Work—Permits logger to be started or stopped several times	

Data Graph

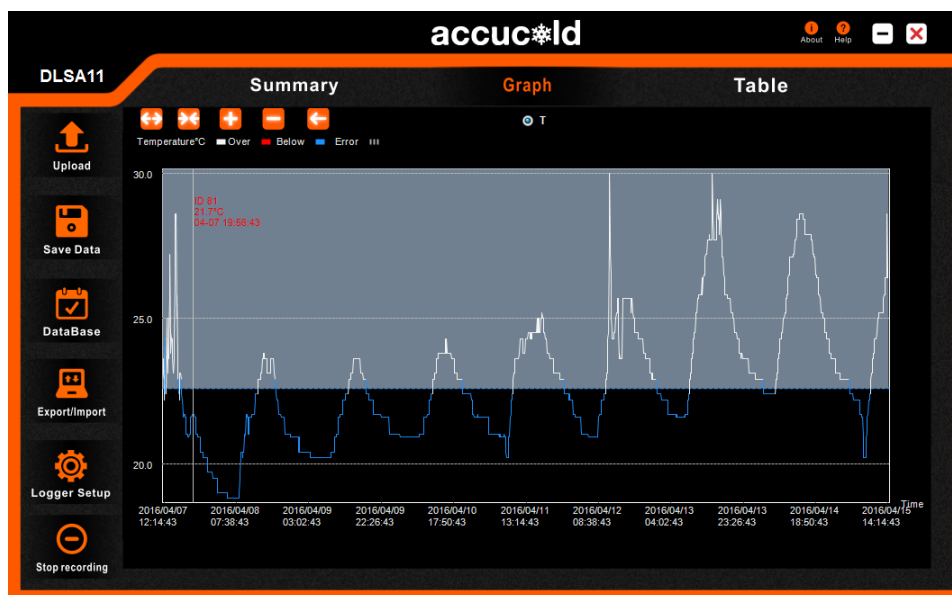

Function buttons	
	Stretches curve horizontally
	Contracts curve horizontally
	Zooms in
	Zooms out
	Returns curve to original size

Data table

The screenshot shows the 'DLSA11' software interface with a 'Table' view. The table contains 100 rows of data, each with four columns: ID, Time, T°C, and RH. The data is organized into four groups of 25 rows each. The interface also features a sidebar with icons for 'Upload', 'Save Data', 'DataBase', 'Export/Import', and 'Logger Setup'. At the bottom, there are navigation controls including 'First', 'Back', 'Next', 'End', and a 'GO' button next to the page number '1 / 20 1947'.

ID	Time	T°C	RH	ID	Time	T°C	RH	ID	Time	T°C	RH	ID	Time	T°C	RH
1	2016/04/07 11:56:43	22.9	N/A	26	2016/04/07 14:26:43	23.8	N/A	51	2016/04/07 16:56:43	22.4	N/A	76	2016/04/07 19:26:43	21.6	N/A
2	2016/04/07 12:02:43	23.6	N/A	27	2016/04/07 14:32:43	24.3	N/A	52	2016/04/07 17:02:43	22.4	N/A	77	2016/04/07 19:32:43	21.6	N/A
3	2016/04/07 12:08:43	23.1	N/A	28	2016/04/07 14:38:43	23.6	N/A	53	2016/04/07 17:08:43	22.2	N/A	78	2016/04/07 19:38:43	21.6	N/A
4	2016/04/07 12:14:43	22.9	N/A	29	2016/04/07 14:44:43	23.1	N/A	54	2016/04/07 17:14:43	22.2	N/A	79	2016/04/07 19:44:43	21.7	N/A
5	2016/04/07 12:20:43	22.4	N/A	30	2016/04/07 14:50:43	23.1	N/A	55	2016/04/07 17:20:43	21.7	N/A	80	2016/04/07 19:50:43	21.7	N/A
6	2016/04/07 12:26:43	22.2	N/A	31	2016/04/07 14:56:43	23.6	N/A	56	2016/04/07 17:26:43	21.6	N/A	81	2016/04/07 19:56:43	21.7	N/A
7	2016/04/07 12:32:43	24.3	N/A	32	2016/04/07 15:02:43	24.3	N/A	57	2016/04/07 17:32:43	21.7	N/A	82	2016/04/07 20:02:43	21.7	N/A
8	2016/04/07 12:38:43	22.4	N/A	33	2016/04/07 15:08:43	26.4	N/A	58	2016/04/07 17:38:43	21.7	N/A	83	2016/04/07 20:08:43	21.7	N/A
9	2016/04/07 12:44:43	22.4	N/A	34	2016/04/07 15:14:43	27.1	N/A	59	2016/04/07 17:44:43	21.7	N/A	84	2016/04/07 20:14:43	21.7	N/A
10	2016/04/07 12:50:43	22.4	N/A	35	2016/04/07 15:20:43	28.6	N/A	60	2016/04/07 17:50:43	21.7	N/A	85	2016/04/07 20:20:43	21.7	N/A
11	2016/04/07 12:56:43	22.4	N/A	36	2016/04/07 15:26:43	28.4	N/A	61	2016/04/07 17:56:43	21.6	N/A	86	2016/04/07 20:26:43	21.6	N/A
12	2016/04/07 13:02:43	25	N/A	37	2016/04/07 15:32:43	28.6	N/A	62	2016/04/07 18:02:43	21.6	N/A	87	2016/04/07 20:32:43	21.6	N/A
13	2016/04/07 13:08:43	23.6	N/A	38	2016/04/07 15:38:43	25	N/A	63	2016/04/07 18:08:43	21	N/A	88	2016/04/07 20:38:43	21.6	N/A
14	2016/04/07 13:14:43	23.1	N/A	39	2016/04/07 15:44:43	25.8	N/A	64	2016/04/07 18:14:43	21	N/A	89	2016/04/07 20:44:43	21.6	N/A
15	2016/04/07 13:20:43	23.6	N/A	40	2016/04/07 15:50:43	25.8	N/A	65	2016/04/07 18:20:43	21	N/A	90	2016/04/07 20:50:43	21	N/A
16	2016/04/07 13:26:43	25	N/A	41	2016/04/07 15:56:43	23.6	N/A	66	2016/04/07 18:26:43	21	N/A	91	2016/04/07 20:56:43	21	N/A
17	2016/04/07 13:32:43	23.6	N/A	42	2016/04/07 16:02:43	22.9	N/A	67	2016/04/07 18:32:43	21	N/A	92	2016/04/07 21:02:43	21	N/A
18	2016/04/07 13:38:43	24.3	N/A	43	2016/04/07 16:08:43	22.4	N/A	68	2016/04/07 18:38:43	21	N/A	93	2016/04/07 21:08:43	21	N/A
19	2016/04/07 13:44:43	25.8	N/A	44	2016/04/07 16:14:43	22.4	N/A	69	2016/04/07 18:44:43	20.9	N/A	94	2016/04/07 21:14:43	21	N/A
20	2016/04/07 13:50:43	27.2	N/A	45	2016/04/07 16:20:43	22.4	N/A	70	2016/04/07 18:50:43	20.9	N/A	95	2016/04/07 21:20:43	20.9	N/A
21	2016/04/07 13:56:43	24.3	N/A	46	2016/04/07 16:26:43	22.2	N/A	71	2016/04/07 18:56:43	20.9	N/A	96	2016/04/07 21:26:43	20.9	N/A
22	2016/04/07 14:02:43	23.8	N/A	47	2016/04/07 16:32:43	23.1	N/A	72	2016/04/07 19:02:43	21	N/A	97	2016/04/07 21:32:43	20.9	N/A
23	2016/04/07 14:08:43	24.5	N/A	48	2016/04/07 16:38:43	23.1	N/A	73	2016/04/07 19:08:43	21	N/A	98	2016/04/07 21:38:43	20.9	N/A
24	2016/04/07 14:14:43	24.3	N/A	49	2016/04/07 16:44:43	23.1	N/A	74	2016/04/07 19:14:43	21	N/A	99	2016/04/07 21:44:43	20.9	N/A
25	2016/04/07 14:20:43	24.3	N/A	50	2016/04/07 16:50:43	22.9	N/A	75	2016/04/07 19:20:43	21	N/A	100	2016/04/07 21:50:43	20.9	N/A

◀ First — Displays first page data

◀ Back — Displays previous page data







▶ Next — Displays next page data

▶▶ End — Displays last page data

GO — Skips to a specific page

3. Data query page

Device	Data Points	Highest	Lowest	Start Time	Stop Time	Status
EL1508000026_000000001	32000	32°C	24.1°C	2015/09/24 16:47:56	2015/09/24 18:11:16	OK
EL1508000006_000000001	32000	31.6°C	23.3°C	2015/09/14 09:11:30	2015/09/24 15:43:00	OK
EL1509054541_123	2	26.4°C	26.2°C	2015/09/16 09:11:24	2015/09/16 09:11:34	Alarm
EL1509054541_000000001	32000	65.7°C	23.6°C	2015/09/02 08:36:44	2015/09/07 10:45:54	OK
EL1507123564_hh	4	27.8°C	27.6°C	2015/08/20 10:54:17	2015/08/20 10:54:47	Alarm
EL1507123564_ff	4	28°C	27.7°C	2015/08/18 14:38:51	2015/08/18 14:39:21	OK
EL1507123564_dddd	2	27.4°C	27°C	2015/08/18 13:34:46	2015/08/18 13:34:56	OK
EL1507123564_123456789	8684	30.4°C	25°C	2015/08/06 09:59:00	2015/08/07 10:06:10	OK
EL1508000014_0123456789	68	28.3°C	1.7°C	2015/08/07 15:51:45	2015/08/07 16:02:55	OK
EL1508000002_0123456789	198	27.8°C	-12.3°C	2015/08/07 15:51:34	2015/08/07 16:24:24	OK
EL1508000005_0123456789	97	28°C	-4.6°C	2015/08/07 15:52:07	2015/08/07 16:08:07	OK
EL1508000001_0123456789	154	28.6°C	-14.5°C	2015/08/07 15:52:35	2015/08/07 16:18:05	OK
EL1508000003_0123456789	70	28°C	-5.2°C	2015/08/07 15:52:20	2015/08/07 16:03:50	OK
EL1508000010_0123456789	26131	64.7°C	26.5°C	2015/08/07 15:54:59	2015/08/10 16:29:59	Alarm
EL1508000004_0123456789	26105	65.5°C	27.2°C	2015/08/07 15:55:12	2015/08/10 16:25:52	OK
EL1508000007_0123456789	26086	65.9°C	27.4°C	2015/08/07 15:54:16	2015/08/10 16:21:46	OK
EL1508000011_0123456789	9815	65.9°C	27.2°C	2015/08/07 15:55:27	2015/08/08 19:11:07	Alarm
EL1508000009_0123456789	13562	149.9°F	80.9°F	2015/08/07 15:54:45	2015/08/09 05:34:55	Alarm
EL1508134345_0123456789	695	28.2°C	23.8°C	2015/08/06 09:57:14	2015/08/13 15:27:14	Alarm
EL1508324242_0123456789	7456	29.6°C	20.3°C	2015/08/06 09:50:06	2015/08/12 10:47:36	Alarm

	Selects all loggers
	Views the detailed information of the selected logger
	Deletes the data of selected logger
	Displays all loggers that have exceeded upper/lower limit
	Displays all recording (including normal temperature data and over temperature data)
	Data management function
	Back to home page

4. Data management page

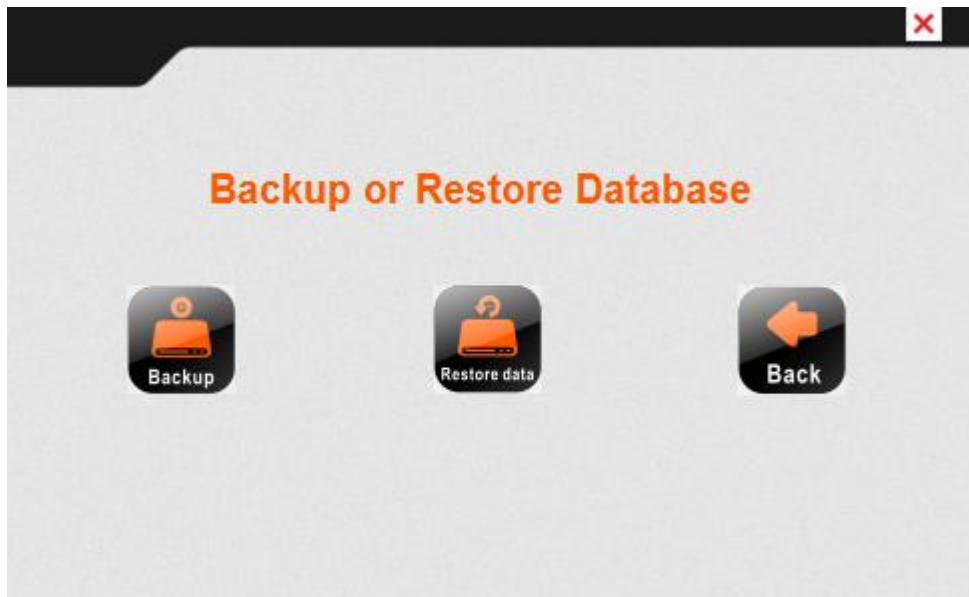

Backup

—Data backup (saves data in the format of ELT)



Restore data

—Data restore (restores ELT file and reads it by software)



Back

—Back to home page

5. Parameter setting page

accu*Id

Serial Number: EL1604060006 Description: 11111111

Trip Id: 1111111 (7 characters max)

Log Interval: 0 H 6 M 0 S Cycle: 133D 7H 54M 0S (100 characters or numbers)

Stop Mode: Manual Software Multiple Work: Disable Probe Type: Internal

Start Mode: Right Now Time Base: UTC +08:00 Temp. unit: °C

Start Delay: 0 H 0 M Report Language: English Buffer Ring: Disable





Start Time: 2016 Y 4 M 13 D 16 H 23 M 57 S Battery: Full

No Alarm Multiple Alarm

Alarm Zones	Temperature	Alarm Mode	Allow Time
<input checked="" type="checkbox"/> H3:	55.9 °C <small>°C "has to be used as decimal divider.</small>	Single	0 H 5 M 0 S
<input checked="" type="checkbox"/> H2:	44.8 °C	Cumulative	0 H 8 M 0 S
H1:	33.7 °C	Cumulative	0 H 6 M 0 S
L1:	22.6 °C	Cumulative	0 H 6 M 0 S
<input checked="" type="checkbox"/> L2:	11.5 °C	Cumulative	0 H 4 M 0 S
<input checked="" type="checkbox"/> H1:	53.4 %RH	Cumulative	0 H 0 M 10 S
<input checked="" type="checkbox"/> L1:	35.3 %RH	Cumulative	0 H 0 M 10 S

Parameter information:

Serial Number —Data logger ID	Start Mode—Logger start mode
Trip ID—Travel ID number	Travel DSC—Travel description
Log Interval—Record interval	Report Language—Report Language
Time Base—Time Base	Battery—Battery display
Cycle—Total record time available	No Alarm —Alarm threshold not set
Password—Setting password	Stop Mode—Logger stop modes
Multiple Alarm—Set several alarm thresholds	
Multiple Work—Permit logger to be started or stopped several times	
Probe Type—Temperature sensor type (internal or external)	
Start time—Logger starts automatically at set time	

 save	 Save Setting	 Load Setting	 Back	
Saves parameters	Saves parameter setting	Loads parameter setting	Back to home page	Sensor adjustment

6. Sensor Adjustment

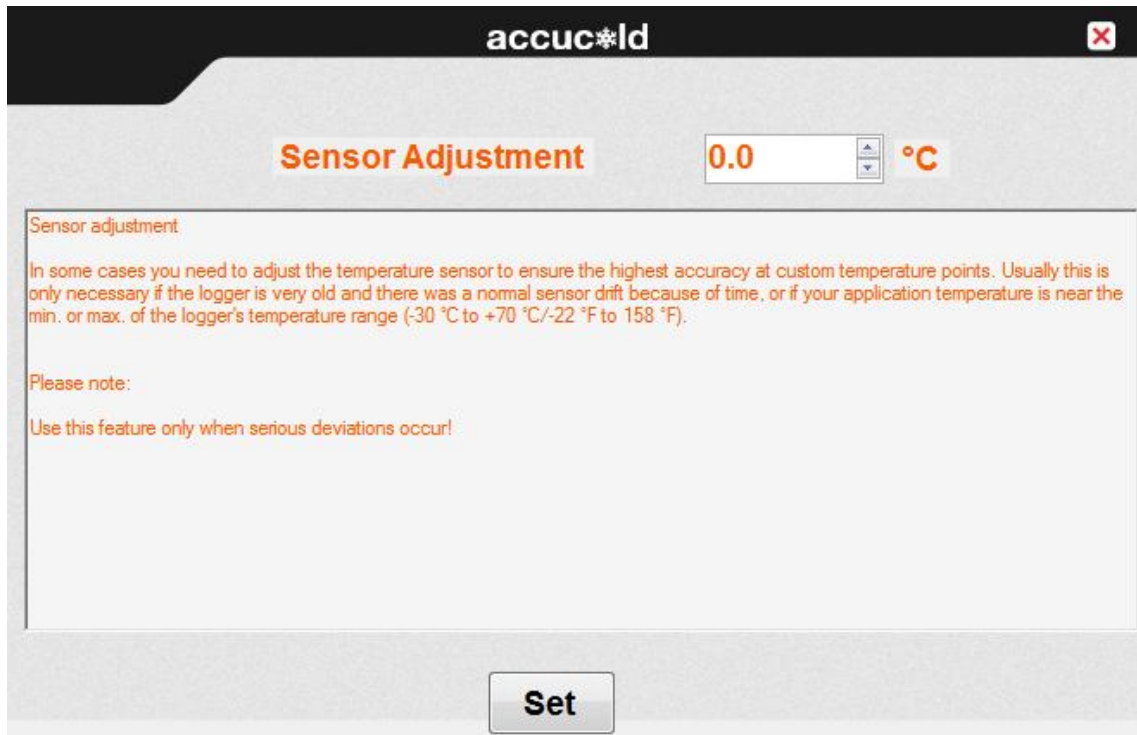

accu*Id [Close]

Sensor Adjustment 0.0 °C

Sensor adjustment.

In some cases you need to adjust the temperature sensor to ensure the highest accuracy at custom temperature points. Usually this is only necessary if the logger is very old and there was a normal sensor drift because of time, or if your application temperature is near the min. or max. of the logger's temperature range (-30 °C to +70 °C/-22 °F to 158 °F).

Please note:

Use this feature only when serious deviations occur!

Set

7. Export data page

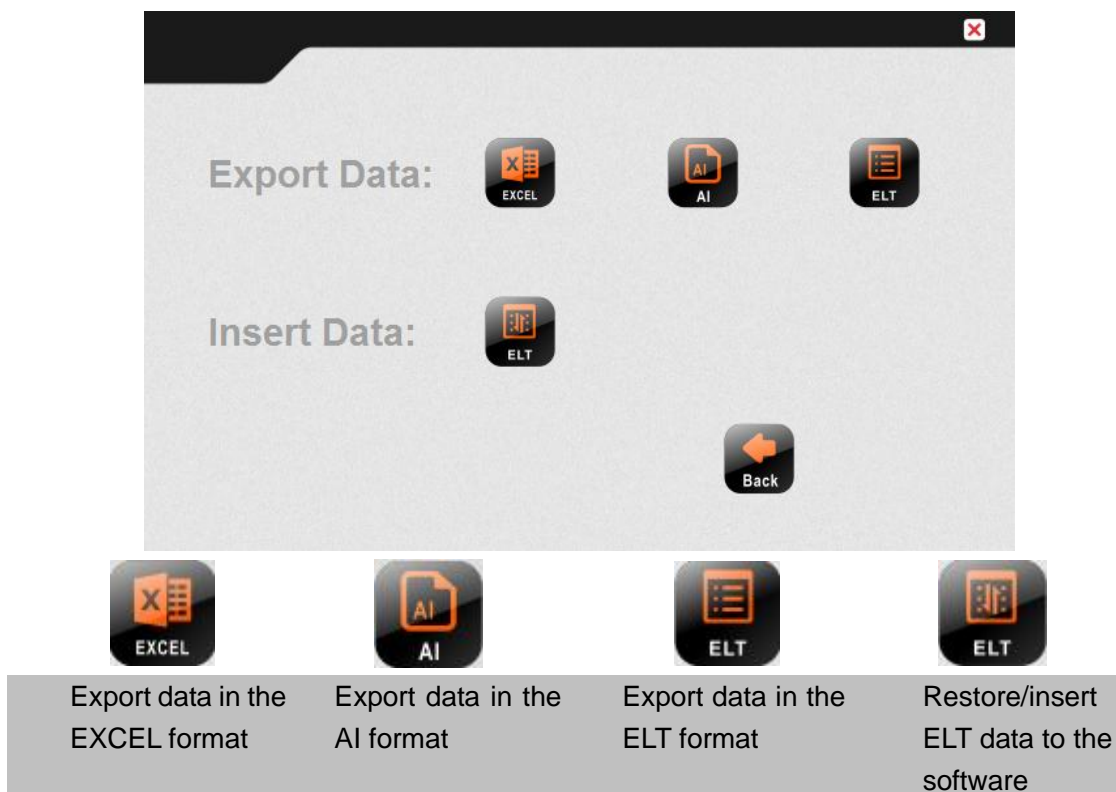

Customer Support

For technical support, please call 800-932-4267 (U.S. and Canada) or email info@summitappliance.com; for calibration services please contact calibration@summitappliance.com.

Limited Warranty

Within the 48 contiguous United States, for 90 days from the date of purchase, when this appliance is operated and maintained according to instructions furnished with the product, warrantor will pay for factory-specified parts and repair labor to correct defects in materials or workmanship. Service must be provided by a designated service company. Outside the 48 states, all parts are warranted for 90 days from manufacturing defects. Plastic parts are warranted to be manufactured to commercially acceptable standards, and are not covered from damage during handling or breakage. Warrantor will not pay for damage resulting from accident, alteration, misuse, abuse, fire, flood, acts of God, improper installation, installation not in accordance with electrical codes, or use or modifications of products not approved by warrantor.