

# 650-10-1

---

*Neonatal Scale*

# Operation Manual



© Rice Lake Weighing Systems. All rights reserved.

Rice Lake Weighing Systems® is a registered trademark of  
Rice Lake Weighing Systems.

All other brand or product names within this publication are trademarks or  
registered trademarks of their respective companies.

All information contained within this publication is, to the best of our knowledge, complete and  
accurate at the time of publication. Rice Lake Weighing Systems reserves the right to make  
changes to the technology, features, specifications and design of the equipment without notice.

The most current version of this publication, software, firmware and all other product  
updates can be found on our website:

[www.ricelake.com](http://www.ricelake.com)

# Revision History

---

This section tracks and describes manual revisions for awareness of major updates.

Revision	Date	Description
D	February 14, 2023	Established revision history, updated formatting to standard, updated battery specs.
E	December 9, 2024	Added disposal instructions

*Table i. Revision Letter History*



*Technical training seminars are available through Rice Lake Weighing Systems. Course descriptions and dates can be viewed at [www.ricelake.com/training](http://www.ricelake.com/training) or obtained by calling 715-234-9171 and asking for the training department.*

# Contents

---

<b>1.0 Introduction</b>	<b>5</b>
1.1 Safety	6
1.2 Safety Signals	6
1.3 Safety and Information Symbols	6
1.4 Assembly	7
1.4.1 Unpacking the Scale	7
1.4.2 Repacking	7
1.5 Setting up the Scale	7
1.5.1 Inserting Batteries	7
1.5.2 Optional AC Power Supply	8
<b>2.0 Scale Setup</b>	<b>9</b>
2.1 Display Annunciators	10
2.2 Before Using the Scale	10
2.3 Weighing	11
2.4 Hold and Release Function	11
2.5 Scale Operation with Manual Tare	11
2.6 Preset Tare	11
<b>3.0 Communication</b>	<b>12</b>
3.1 Pushbutton Keypad Print	12
3.2 USB Connection	12
<b>4.0 Troubleshooting &amp; Maintenance</b>	<b>15</b>
4.1 Maintenance	15
4.2 Cleaning	15
<b>5.0 Specifications</b>	<b>16</b>



Rice Lake continually offers web-based video training on a growing selection of product-related topics at no cost. Visit [www.ricelake.com/webinars](http://www.ricelake.com/webinars)

# 1.0 Introduction

The 650-10-1 Neonatal Scale provides precise weighing of infants and newborns. The scale is equipped with Motiontrap™, a special motion sensing weighing technology, which compensates for involuntary movement caused by an active infant. The infant's weight can be displayed in pounds and ounces or kilograms and grams. The weight is displayed until reweighing is performed or until the scale zeros out.



Manuals are available from Rice Lake Weighing Systems at [www.ricelake.com/manuals](http://www.ricelake.com/manuals)

Warranty information is available at [www.ricelake.com/warranties](http://www.ricelake.com/warranties)

## 1.1 FCC Compliance

### United States

This equipment has been tested and found to comply with the limits for a Class A digital device, pursuant to Part 15 of the FCC Rules. These limits are designed to provide reasonable protection against harmful interference when the equipment is operated in a commercial environment. This equipment generates, uses and can radiate radio frequency energy and, if not installed and used in accordance with the instruction manual, may cause harmful interference to radio communications. Operation of this equipment in a residential area is likely to cause harmful interference in which case the user will be required to correct the interference at his own expense.

### Canada

This digital apparatus does not exceed the Class A limits for radio noise emissions from digital apparatus set out in the Radio Interference Regulations of the Canadian Department of Communications.

Le présent appareil numérique n'émet pas de bruits radioélectriques dépassant les limites applicables aux appareils numériques de la Class A prescrites dans le Règlement sur le brouillage radioélectrique édicté par le ministère des Communications du Canada.

## 1.2 Disposal



### Product Disposal

The product must be brought to appropriate separate waste collection centers at the end of its life cycle.

Proper separate collection to recycle the product helps prevent possible negative effects on the environment and to health, and promotes the recycling of the materials. Users who dispose of the product illegally shall face administrative sanctions as provided by law.

### Battery Disposal

Dispose of batteries at appropriate waste collection centers at the end of their life cycle in accordance with local laws and regulations. Batteries and rechargeable batteries may contain harmful substances that should not be disposed of in household waste. Batteries may contain harmful substances including but not limited to: cadmium (Cd), lithium (Li), mercury (Hg) or lead (Pb). Users who dispose of batteries illegally shall face administrative sanctions as provided by law.



**WARNING:** Risk of fire and explosion. Do not burn, crush, disassemble or short-circuit lithium batteries.

## 1.3 Safety

There are certain precautions that should be taken to prevent personal injury to the baby and damage to your scale. Follow instructions for installation and usage. The manufacturer is not responsible for any damage or injury from incorrect operation or manipulation by the user.

## 1.4 Safety Signals

### Safety Definitions:



**DANGER:** Indicates an imminently hazardous situation that, if not avoided, will result in death or serious injury. Includes hazards that are exposed when guards are removed.



**WARNING:** Indicates a potentially hazardous situation that, if not avoided, could result in serious injury or death. Includes hazards that are exposed when guards are removed.



**CAUTION:** Indicates a potentially hazardous situation that, if not avoided, could result in minor or moderate injury.



**IMPORTANT:** Indicates information about procedures that, if not observed, could result in damage to equipment or corruption to and loss of data.

## General Safety



**Do not operate or work on this equipment unless this manual has been read and all instructions are understood. Failure to follow the instructions or heed the warnings could result in injury or death. Contact any Rice Lake Weighing Systems dealer for replacement manuals.**



### WARNING

**Failure to heed could result in serious injury or death.**

**Never leave an infant unattended while on the scale.**

**Do not drop the scale or subject it to violent shocks.**

**Do not transport the scale while the infant is in the weighing tray.**

**For accurate weighing, the scale must be placed on a flat, stable surface.**

**For accurate weighing, verify proper operation according to the procedure described in this manual before each use.**

**Do not use around flammable liquids.**

**Operation at other voltages than specified could damage the equipment.**

**Rice Lake Weighing Systems offers optional adapters. Utilizing an adapter not supplied by us voids all warranties.**

**Do not modify this scale without authorization of the manufacturer.**

**Ensure weighing tray is secured to scale base prior to placing a newborn/infant in the weighing tray.**

**To avoid cross contamination, the scale plate must be cleaned regularly and cleaned after each use. Avoid direct skin contact during weighing. Use disposable paper towels or bed pads for each scale.**

## 1.5 Safety and Information Symbols

The International Electro-technical Commission (IEC) has established a set of symbols for medical electrical equipment, which classifies a connection and warns of any potential hazards.

The classification of symbols are as follows:



### Type BF (Body Protected)

This means that the unit complies with the specified requirements of this standard to provide protection against electric shock.



### Waste Electrical and Electronic Equipment (WEEE)

The device may be sent back to the manufacturer for recycling or proper disposal after its useful life. Alternatively, the device must be disposed in accordance with national laws after its useful life.

## 1.6 Assembly

### 1.6.1 Unpacking the Scale

Place the unopened carton in an open area that has ample room for unpacking the scale.

The 650-10-1 Neonatal Scale comes with four parts:

- Weighing tray
- Base assembly
- USB and RS-232 cable
- Six AA LiFeS<sub>2</sub> lithium iron disulfide batteries

Remove each part to be assembled from the carton and unwrap the packing material carefully to prevent scratching the parts.

### 1.6.2 Repacking

If the 650-10-1 Neonatal Scale must be returned for any reason, it must be properly packed with sufficient packing materials. Whenever possible, use the original carton when shipping the scale back.



**IMPORTANT:** Damage caused from improper packaging is not covered by the warranty.

## 1.7 Setting up the Scale

To set up the scale, select a sturdy, flat surface on which to place the scale.

### 1.7.1 Inserting Batteries

The six AA LiFeS<sub>2</sub> lithium iron disulfide batteries that come with the scale offer an average of 25 hours of continuous use. To install the batteries:

1. Tip the unit to reveal the battery chamber plate location.



**IMPORTANT:** Do not tip the scale completely up side down as this could damage the load cells.

2. Using a small Phillips head screwdriver, unscrew the four screws from the battery chamber cover and set aside.
3. Insert the six batteries into the battery chamber.
4. Close the battery chamber and tighten the screws.
5. Turn the unit right side up on a flat surface.



**NOTE:** When using an external power supply, or when a USB power supply is connected, the battery icon on the display is turned off. When using batteries, the backlight power is reduced to 60 percent.

6. Remove the two angular transport tabs from the scale as shown in [Figure 1-1](#).

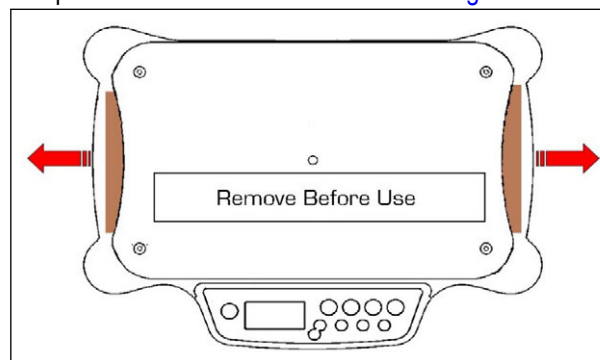

Figure 1-1. Angular Transport Tab Location

7. Rotate the adjustable feet located under the scale base to level the scale.

8. Attach the weighing tray to the base assembly.

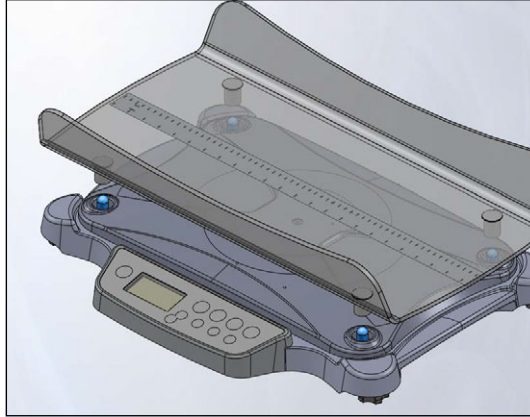

Figure 1-2. Attach Weighing Tray to Scale Base

### 1.7.2 Optional AC Power Supply

The 650-10-1 Neonatal Scale has an optional 120VAC or 230VAC adapter to use when power is available. The optional AC power adapter plugs into the back of the scale as shown in Figure 1-3.



Figure 1-3. Outlet and AC Power Connection Site on Back of Scale



**IMPORTANT:** Rice Lake Weighing Systems offers optional AC adapters. Utilizing an adapter not supplied by Rice Lake voids all warranties.

## 2.0 Scale Setup



Figure 2-1. 650-10-1 Display

The following table identifies and explains the function of the front panel keys of the 650-10-1 Neonatal Scale.









Item	Description	Function
	On/Off	This key turns the scale on and off.
	Reweigh	This key allows repeated reweighing of an infant. A long key press activates the print function.
	Hold/Release	The first key press holds the most current weight value shown on the display. A second key press releases the weight value shown.
	Tare	With weight on the scale, press the Tare key to tare out the scale and return it to zero. The display annunciator turns to Net.
	Zero	This key zeros the weight of the scale. It attempts to zero for three seconds and works only if the weight is stable.
	Units/Clear	This key toggles between Lb and Kg on the display. The Clear function is used in setup mode only and is used to clear the display.
	Enter	This key is used while in setup mode only.
	Shift Left	Press to shift the flashing digit one digit to the left. This key is also used when entering a preset tare.
	Up/Down Arrows	Press to adjust the value of the flashing digit/number during menu setup. This key is also used for adjusting a preset tare value.

Table 2-1. Front Panel Keys

## 2.1 Display Annunciators

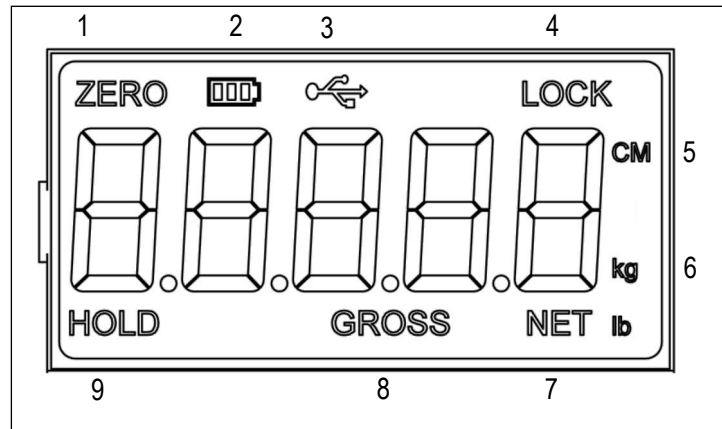

Figure 2-2. Available Display Annunciators

Item	Description	Function
1	Zero	This zeros the digital display prior to weighing. It enables the cancellation (tare) of extra weight of blankets, or other items on the scale.
2	Battery	When the scale is on, this annunciator indicates that the scale battery is running the scale - not AC power.
3	USB	This annunciator indicates that the USB port is available.
4	Lock	This annunciator indicates that the scale weight has been locked in and will not disappear from the scale display.
5	Unit length	This annunciator displays the unit's length either in inches or centimeters.
6	Unit weight	This annunciator displays the unit's weight either in pounds or kilograms.
7	Net	This indicates that this is the net weight of the infant after blankets or other accessories have been tared off.
8	Gross	Indicates that this is the gross weight of the infant which includes blankets or other items.
9	Hold	Indicates that the weight shown on the display will not change or clear off to zero again even after removing the infant from the scale.

Table 2-2. Annunciator Functions

## 2.2 Before Using the Scale

Use the following steps to set up the 650-10-1 Neonatal Scale upon initial power up.

1. To operate the unit using the AC adapter, plug the AC adapter cable into the back of the scale (as shown in [Figure 1-3 on page 8](#)), and the AC adapter plug into a power source.
2. Press the On/Off button to turn the scale on.
3. When the self test function is complete, the digital display should read: 000.0 (if set up in pounds and ounces) or 0.00 (if set up in kilograms).
4. Place a weight (not exceeding 33 lb /15 kg) on the scale. The weight calculation is complete once the motion indicator turns on.
5. Press the Units/Clear key to select the weight mode.
6. Press the Hold/Release key and remove the weight from the scale. The digital display should continue to show the weight of the item that was on the scale.
7. Press the Hold/Release key again to bring the scale display back to zero.



**NOTE:** If the setup procedure failed, refer to the troubleshooting section of this manual. If the problem is not resolved, refer to a qualified service provider.

## 2.3 Weighing

Use the following steps to weigh an infant or newborn on the 650-10-1 Neonatal Scale.

1. Press the On/Off key to turn the scale on.
2. Wait for the Zero to appear in the display.
3. Press the Tare key to cancel the weight of the pad or other items that is on the weighing tray.
4. Place the infant on the scale until the weight of the infant is determined.
5. Press the Reweigh key to weigh the infant again (this will achieve a more accurate result).
6. Remove the infant from the scale. The digital display goes back to zero.



**NOTE:** *If the scale is not used for two minutes, it switches off in order to save battery life and power. To restart the scale, press the On/Off key.*

## 2.4 Hold and Release Function

Use the following steps to use the Hold/Release function.

1. Press On/Off to turn the scale on.
2. Place the infant on the scale.
3. When the infant is on the scale, press the Hold/Release key.
4. When the infant is taken off the scale, the weight and the Hold annunciator will remain on the display.
5. At this stage the Zero key will not work. To return to zero from here, press the Hold/Release key one more time.



**NOTE:** *Alternatively, press the Hold/Release key a second time prior to removing the infant from the scale.*

## 2.5 Scale Operation with Manual Tare

Use the following steps to use the manual tare function.

1. Press the On/Off key to turn the scale on.
2. When the weight is set to zero, place the item to tare (ie: blanket) on the scale. Press the Tare key until the display returns to zero and the Net annunciator appears on the display.
3. Remove the item (ie: blanket) from the scale. The weight will appear as a negative weight.
4. Place the infant back on the scale with the previously tared item. The display shows the infant's weight. The Net annunciator is still on. Clear the scale of all items and the weight of the extra load remains stored in memory.
5. To cancel the tare weight, press the Tare key until Net disappears from the display. The display turns back to zero and the Gross appears. The tare weight is also canceled when the scale is turned off.

## 2.6 Preset Tare

Use the following steps to use the preset tare function.

1. Press the On/Off key to turn the scale on.
2. Wait until the zero appears on the display and press the Tare key.
3. The default tare value is displayed (default is programmed to be 33.0 lb/15.0 kg) while the zero is flashing.
4. Use the Up/Down and left arrow keys to adjust the value.
5. Press the Enter key to start the tare function and the Net annunciator will be shown instead of the Gross annunciator.

## 3.0 Communication

The scale comes with an RS-232 port which enables weight data to be transmitted to other equipment, such as a computer or printer. The RS-232 cable with a DB-9 connector (PN 100719) is available from Rice Lake Weighing Systems. [Figure 3-1](#) shows where the RS-232 connection is.

The RS-232 parameters are 9600 baud (selectable in the programming mode), 8 data bits, 1 stop bit, no parity and no handshaking.

There are three methods to access weight data from a computer:

- Pushbutton keypad print - Done by pressing and holding the Reweigh key.
- Standard remote protocol - See 650-10-1 Neonatal Scale Technical Manual (PN 172982)
- Escape protocol - See 650-10-1 Neonatal Scale Technical Manual (PN 172982)

### 3.1 Pushbutton Keypad Print

With a stable, in-range weight, press and hold the Reweigh key for at least three seconds. Note that if the scale does not beep after five seconds, then release the button as the weight was either in motion, or out of range. The print will show on the display when it is transmitting data.

If displaying weight, the scale will send out the following 21 character string:

```
xxxxxxxx<SP>uu<SP>mmmmm<SP><CR><LF>
```

Where:

xxxxxxxx is the weight with decimal point and - sign, if negative uu is the unit (pound or kilogram).

mmmmm is the mode (gross or net)

*Examples:*

```
-10 lb net = <SP><SP><SP><SP>-10.0<SP>lb<SP><SP>Net<SP><SP><SP><CR><LF>
```

```
10 lb gross = <SP><SP><SP><SP><SP>-10.0<SP>lb<SP>Gross<SP><CR><LF>
```

### 3.2 USB Connection

The 650-10-1 Neonatal Scale can connect to a PC using a USB connection and a USB cable. See [Figure 3-1](#).

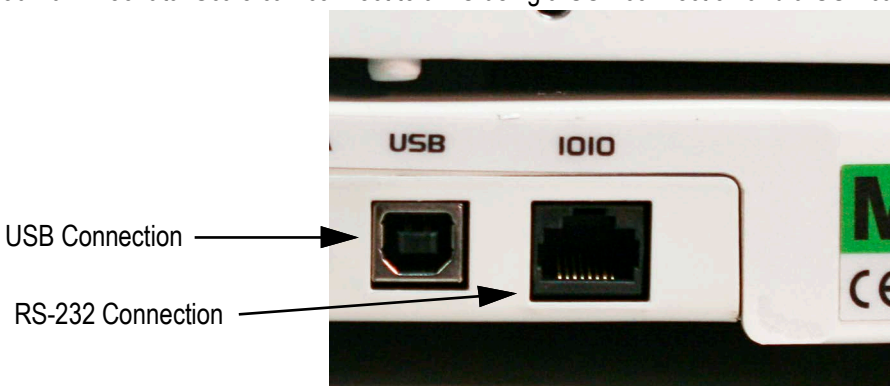

Figure 3-1. USB Connection Port and RS-232 Connection Port

Connecting software and downloads should be addressed by the IT department and can vary depending on what type of computer is being used. Basic information on USB driver installation using Windows® is described in the following steps and serves only as an example.

The USB driver can be downloaded from the Rice Lake Weighing Systems website at <http://www.ricelake.com>. To access that driver, select medical/health scales, software and get downloads. Opening any product will show a USB Driver download. Click on Download to open and download the driver to the computer.

1. The graphic below, shows the window that pops up when the USB cable is connected to the indicator and the scale is turned on.



Figure 3-2. Download Screen for Hardware Wizard

The screen prompts (listed below) show how to navigate through the screens.

2. Select No, Not This Time and then select Next.
3. Select Install The Software Automatically, then select Next.
4. The driver installs on to the PC.
5. When installation is complete. Click on Finish.
6. To verify the installation, the driver can be viewed in the device manager of the system.

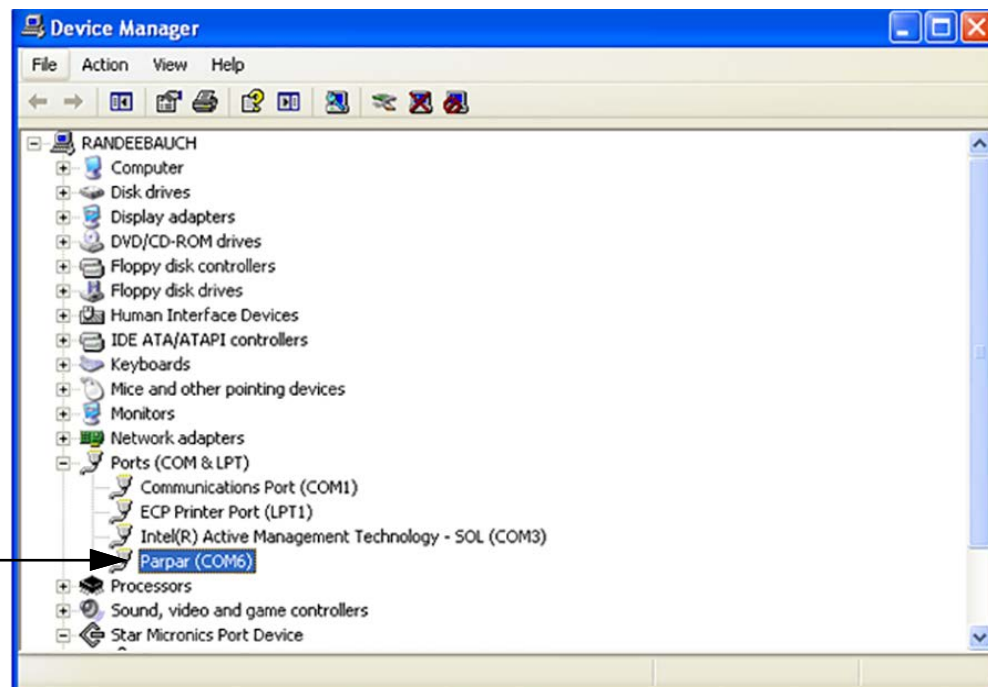

Figure 3-3. Device Manager File Location

7. To print a ticket using the USB driver, open the software driver (shown above) and the port assigned to that driver is shown.
8. Ensure that the USB cable is properly connected and unit is on.
9. Another terminal type program (such as Hyperterminal) needs to be opened and connected through the USB driver to the indicator to be able to see the information being sent to the PC. A port needs to be established so select the port that is assigned to Parpar and print the ticket. The following example tickets will print.

PATIENT WEIGHT	2.104 lb	WEIGHT
NET WEIGHT	1.103 lb	WEIGHT

Figure 3-4. Print Ticket Examples



**NOTE:** A single print ticket has four spaces after the patient weight and only one space between the weight and lb in the examples shown in [Figure 3-4](#). Then seven <CR><LF> after.

## 4.0 Troubleshooting & Maintenance

Refer to the following instructions to check and correct any failure before consulting service personnel.

Symptom	Possible Cause	Corrective Action
The scale does not turn on.	Dead batteries	Connect the scale to a power source or change batteries.
	Faulty electrical outlet	Use a different electrical outlet.
	Bad power supply	Replace optional adapter.
Questionable weight or the scale does not zero.	External object is interfering with the scale.	Remove the infant/interfering object from the weighing tray from the scale.
	Display did not show 0.0 before weighing.	Remove the infant, zero the scale and begin the weighing process again.
	Scale is not placed on a level surface.	Place the scale on a stable surface and begin the weighing process again.
	The weighing tray is not placed properly.	Place the weighing tray in its proper place.
	Scale is out of calibration.	Check the scale with a known weight value.
The display shows o_Ld message.	The load on the scale exceeds the capacity.	Remove the excess weight and use the scale according to its stated limit.
The display shows Err.	The Recall key was pressed with insufficient weight on the scale.	Place more than 2 lb, 30 oz on the scale.

Table 4-1. Troubleshooting

### 4.1 Maintenance

The following section provides instructions for maintaining and cleaning the 650-10-1 Neonatal Scale. Maintenance operations other than those described in this section should only be performed by qualified service personnel.

Before the first use of the scale and after periods of non-use, check the scale for proper operation and function. If the scale does not operate correctly, contact qualified service personnel.

Use the following steps for basic maintenance:

1. Check the overall appearance of the entire scale for any obvious signs of damage, abuse, etc.
2. Inspect the condition of the optional AC adapter for cord cracking or fraying, or for broken or bent prongs.

### 4.2 Cleaning

Proper care and cleaning is essential to ensure a long life of accurate and effective operation. Before beginning the cleaning process, disconnect the scale from the AC power source.

1. Clean all external surfaces with a clean, damp cloth or tissue. Mild soap and water solution may be used. Dry with a clean soft cloth.
2. Do not immerse the scale into cleaning or other liquid solutions.
3. Do not use Isopropyl alcohol or other solutions to clean the display surface.

## 5.0 Specifications

---

**Capacity:**

Range 1: 0 to 10 lb × 0.05 oz (0 to 5 kg × 1 g)

Range 2: 10 to 33 lb × 0.1 oz (5 to 15 kg × 2 g)

**Power:**

12 VDC, provided by six AA lithium batteries (included) or AC adapter (optional)

**Measuring Tape:**

0 to 23.5 in × 0.125 in

(0 to 60 cm × 0.25 cm)

**Battery Type:**

Six Li-FeS<sub>2</sub> batteries

**Operating Temperature:**

50 °F to 95 °F (10 °C to 35 °C)

**Display:**

5-digit LCD display, 0.75 in (1.9 mm) digit height

**Warranty:**

Two-year limited

**Approvals:**



Met E113986