

650-10-1

Neonatal Scale

Technical Manual



© Rice Lake Weighing Systems. All rights reserved.

Rice Lake Weighing Systems® is a registered trademark of
Rice Lake Weighing Systems.

All other brand or product names within this publication are trademarks or
registered trademarks of their respective companies.

All information contained within this publication is, to the best of our knowledge, complete and accurate at the time of publication. Rice Lake Weighing Systems reserves the right to make changes to the technology, features, specifications and design of the equipment without notice.

Revision History

This section tracks and describes manual revisions for awareness of major updates.

Revision	Date	Description
E	February 14, 2023	Established revision history. Added current formatting and battery updates.
F	November 21, 2024	Added disposal instructions

Table i. Revision Letter History



Technical training seminars are available through Rice Lake Weighing Systems. Course descriptions and dates can be viewed at www.ricelake.com/training or obtained by calling 715-234-9171 and asking for the training department.

Contents

1.0 Introduction	5
1.1 FCC Compliance	6
1.2 Disposal	6
1.3 Information Symbols	6
1.4 Scale Display	7
1.5 Operation	8
1.5.1 Before Using the Scale	8
1.5.2 Weighing	8
1.5.3 Hold and Release Function	8
1.5.4 Manual Tare	9
1.6 Preset Tare	9
2.0 Assembly	10
2.1 Unpacking	10
2.2 Powering the Scale	10
2.2.1 Install Batteries	10
2.2.2 Battery Status	10
2.2.3 AC Power Supply – Optional	11
2.2.4 Scale Setup	11
3.0 Scale Configuration	12
3.1 Menu Parameters	12
3.1.1 User Menu	12
3.1.2 Verification Menu	13
3.1.3 Maintenance Menu	13
3.1.4 Programming Menu	14
4.0 Calibration	15
5.0 RS-232 Communication	16
5.1 Pushbutton Keypad Print	16
5.2 USB Connection	16
6.0 Troubleshooting and Maintenance	19
6.1 Troubleshooting & Testing	19
6.2 Maintenance	19
6.2.1 Basic Maintenance	19
6.2.2 Cleaning	19
7.0 Specifications	20



Rice Lake continually offers web-based video training on a growing selection of product-related topics at no cost. Visit www.ricelake.com/webinars

1.0 Introduction

The 650-10-1 Neonatal Scale provides precise weighing of infants and newborns. The scale is equipped with Motiontrap™, a special motion sensing weighing technology, which compensates for involuntary movement caused by an active infant. The infant's weight can be displayed in pounds/ounces or in kilograms/grams. The weight is displayed until reweighing is performed or until the scale zeros out.

There are precautions that must be taken to prevent injury to the baby and damage to the scale.

Follow all instructions for installation and usage included in this manual. The manufacturer is not responsible for any damage or injury from incorrect operation or manipulation by the user.



Manuals are available from Rice Lake Weighing Systems at www.ricelake.com/manuals

Warranty information is available at www.ricelake.com/warranties

Safety Definitions:



DANGER: Indicates an imminently hazardous situation that, if not avoided, will result in death or serious injury. Includes hazards that are exposed when guards are removed.



WARNING: Indicates a potentially hazardous situation that, if not avoided, could result in serious injury or death. Includes hazards that are exposed when guards are removed.



CAUTION: Indicates a potentially hazardous situation that, if not avoided, could result in minor or moderate injury.



IMPORTANT: Indicates information about procedures that, if not observed, could result in damage to equipment or corruption to and loss of data.

General Safety



Do not operate or work on this equipment unless this manual has been read and all instructions are understood. Failure to follow the instructions or heed the warnings could result in injury or death. Contact any Rice Lake Weighing Systems dealer for replacement manuals.



WARNING

Failure to heed could result in serious injury or death.

Never leave an infant unattended on the scale.

Ensure weighing tray is secured to scale base prior to placing an infant/newborn on weighing tray.

Do not transport the scale with the infant in the weighing tray.

Do not use around flammable materials.

Scale should only be used to determine weight of infant/newborns. It is not intended to diagnose, prevent and monitor diseases.

To avoid cross contamination, the scale plate must be cleaned after each use. Avoid direct skin contact during weighing. Use disposable paper towels or bed pads for each scale.

Operation at other voltages than specified could damage the equipment.

Rice Lake Weighing Systems offers optional adapters. Utilizing an adapter not supplied by the company voids all warranties.

Do not modify this scale without authorization of the manufacturer.

Do not drop the scale or subject it to violent shocks.

For accurate weighing, the scale must be placed on a flat, stable surface.

For accurate weighing, verify proper operation according to the procedure described in this manual before each use.

1.1 FCC Compliance

United States

This equipment has been tested and found to comply with the limits for a Class A digital device, pursuant to Part 15 of the FCC Rules. These limits are designed to provide reasonable protection against harmful interference when the equipment is operated in a commercial environment. This equipment generates, uses and can radiate radio frequency energy and, if not installed and used in accordance with the instruction manual, may cause harmful interference to radio communications. Operation of this equipment in a residential area is likely to cause harmful interference in which case the user will be required to correct the interference at his own expense.

Canada

This digital apparatus does not exceed the Class A limits for radio noise emissions from digital apparatus set out in the Radio Interference Regulations of the Canadian Department of Communications.

Le présent appareil numérique n'émet pas de bruits radioélectriques dépassant les limites applicables aux appareils numériques de la Class A prescrites dans le Règlement sur le brouillage radioélectrique édicté par le ministère des Communications du Canada.

1.2 Disposal



Product Disposal

The product must be brought to appropriate separate waste collection centers at the end of its life cycle.

Proper separate collection to recycle the product helps prevent possible negative effects on the environment and to health, and promotes the recycling of the materials. Users who dispose of the product illegally shall face administrative sanctions as provided by law.

Battery Disposal

Dispose of batteries at appropriate waste collection centers at the end of their life cycle in accordance with local laws and regulations. Batteries and rechargeable batteries may contain harmful substances that should not be disposed of in household waste. Batteries may contain harmful substances including but not limited to: cadmium (Cd), lithium (Li), mercury (Hg) or lead (Pb). Users who dispose of batteries illegally shall face administrative sanctions as provided by law.



WARNING: Risk of fire and explosion. Do not burn, crush, disassemble or short-circuit lithium batteries.

1.3 Information Symbols

The International Electro-Technical Commission (IEC) has established a set of symbols for medical electrical equipment, which classify a connection or warning as a potential hazard.

The classification of symbols is as follows:



Type BF (Body Protected)

This means that the unit complies with the specified requirements of this standard to provide protection against electric shock.



Waste Electrical and Electronic Equipment (WEEE)

The device can be sent back to the manufacturer for recycling or proper disposal. Alternatively, the device must be disposed in accordance with national laws when scale is no longer used.

1.4 Scale Display

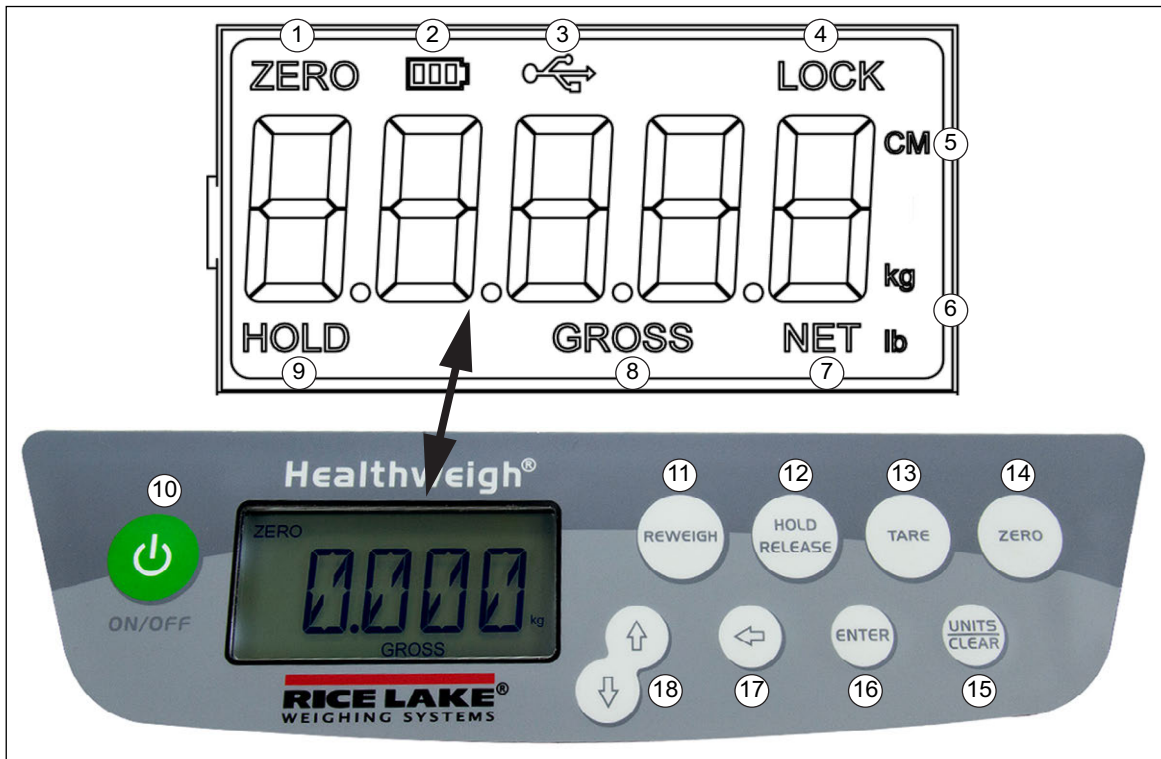

Figure 1-1. 650-10-1 Neonatal Scale Display





Item No.	Description	Function
1	Zero	Zeros display; enables tare of weight for weighing accessories
2	Battery Icon	Indicates scale is running on battery power
3	USB	Indicates USB port is available
4	Lock	Indicates scale weight is locked and will remain on display
5	Unit length	Displays baby's length; inches or centimeters
6	Unit weight	Displays baby's weight; pounds or kilograms
7	Net	Indicates net weight of infant after blankets/accessories have been tared off
8	Gross	Indicates gross weight of infant including blankets/accessories
9	Hold	Displayed weight remains on display after removing infant from scale
10	On/Off	Turns scale on/off
11	Reweigh	Allows repeated reweighing of an infant; a long key press activates the print function
12	Hold/Release	First press holds current weight on display; a second press releases it
13	Tare	Removes weight of items used to place baby on scale; scale zeros and NET displays
14	Zero	Returns scale to zero, only works if the weight is stable
15	Units/Clear	Toggles between lb and kg on display; Clear function is used in setup mode only
16	Enter	Used in setup mode only
17	Shift Left	Press to shift the flashing digit to the left when entering a preset tare
18	Up/Down Arrows	Adjusts the value of the flashing digit/number during menu setup; also used for adjusting a preset tare value

Table 1-1. 650-10-1 Neonatal Scale Display

1.5 Operation

1.5.1 Before Using the Scale

Use the following steps for initial setup.



1. Press  to turn on scale. After self test, 0 displays.
2. Place weight (maximum 33 lb/15 kg) on the scale. ===== flashes on the displays until weight calculation is complete. The weight calculation is complete once the motion indicator turns on.
3. Press  to select the weight mode, lb or kg.
4. Press . Remove the weight, the weight continues to display.
5. Press  to remove hold. 0 displays.



NOTE: If the setup procedure failed, see [Section 6.1 on page 19](#). If the problem is not resolved, contact a qualified service provider.

1.5.2 Weighing

Use the following steps to weigh on the scale.



1. Press  to turn the scale on. After self test, 0 displays.
2. Place a pad or other accessory to be used on the weighing tray.
3. Press  to remove the weight of a pad or other accessory, 0 displays.
4. Place the infant on the scale. Infants weight displays.
5. Press  to weigh the infant again, for more accurate results.
6. Remove the infant from the scale. 0 displays.



NOTE: If the scale is not used for two minutes, it turns off.

1.5.3 Hold and Release Function

Use the following steps to use the Hold/Release function.



1. Press  to turn the scale on. After self test, 0 displays.
2. Place the infant on the scale. Infants weight displays.
3. Press .
4. Remove infant from the scale, the weight remains on the scale and Hold displays.
5. Press  to return to zero.



NOTE:  can be pressed with infant still on the scale. Once infant is removed, 0 displays.





1.5.4 Manual Tare

Use the following steps to manually tare the scale.

1. Press  to turn the scale on. After self test, 0 displays.
2. Place the item to tare (blanket, accessories) on the scale.
3. Press  until scale zeros and NET displays. If item is removed from the scale a negative weight displays.
4. Place the infant, with item tared, on the scale. The infant's weight and NET displays.
5. Remove the infant and item tared. The tared weight is stored in memory.
6. To cancel the tare weight, press  until display returns to 0 and Gross displays. The tare weight cancels when the scale is turned off.

1.6 Preset Tare

Use the following steps to set the preset tare.

1. Press  to turn the scale on. After self test, 0 displays.
2. Press . The default tare value is displayed (default is programmed to be 33.0 lb/15.0 kg) while the zero is flashing.
3. Press  and  to adjust the value.
4. Press  to start the tare function. NET displays.

2.0 Assembly

2.1 Unpacking

Open in an area that has room for unpacking the scale. The 650-10-1 Neonatal Scale comes with the following pieces:

- Weighing tray
- Base assembly
- USB and RS-232 cable
- Six AA LiFeS2 lithium iron disulfide batteries

Remove parts from the carton and unwrap the packing material carefully to prevent scratching the parts.

If the 650-10-1 must be returned or shipped to a different location, it must be properly packed with sufficient packing materials. If possible, retain the original carton for shipping or moving the scale.



IMPORTANT: *Damage caused by improper packaging is not covered by the warranty.*

2.2 Powering the Scale

The scale operates on batteries (included) or an AC adapter, available from Rice Lake Weighing Systems.

The scale automatically switches to battery operation when an AC power source is not available.

2.2.1 Install Batteries

1. Set the scale on a sturdy, flat surface.
2. Tip the unit to access the battery chamber.



IMPORTANT: *Do not tip the scale completely up side down, this could damage the load cells.*

3. Remove four screws from the cover plate. Cover plate will come off at the same time. Retain for re-installation.
4. Insert six batteries into the battery chamber according to the diagram inside.
5. Replace the cover plate and secure with screws.
6. Set the scale up right on a flat surface.

2.2.2 Battery Status

Battery status	Flag indicator
Maximum charge	
Medium 2 charge	
Medium 1 charge	
Low charge	
Minimum charge	Flashing
Auto shut off imminent	Scrolls LOW bAt



NOTE: *If when using AC adapter or USB power, the battery icon is off.*

When using battery or USB power supply, the back-light power is reduced to 60%.

AC adapter does not charge the batteries.

Table 2-1. Battery Indicator Status

2.2.3 AC Power Supply – Optional

An optional 120 VAC or 230 VAC adapter is available from Rice Lake Weighing Systems. To operate the unit using the AC adapter, plug the cable into the back of the scale and the AC adapter plug into a power source.

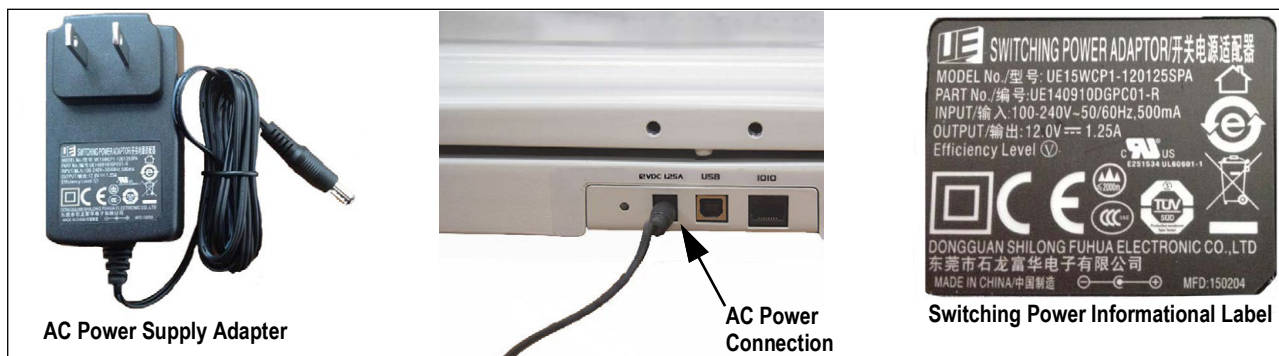

Figure 2-1. AC Power Connection

! **IMPORTANT:** Utilizing an adapter not supplied by Rice Lake voids all warranties.

2.2.4 Scale Setup

1. Ensure the scale is placed on a sturdy, flat surface.
2. Remove the transport support tabs from each corner of the scale base.

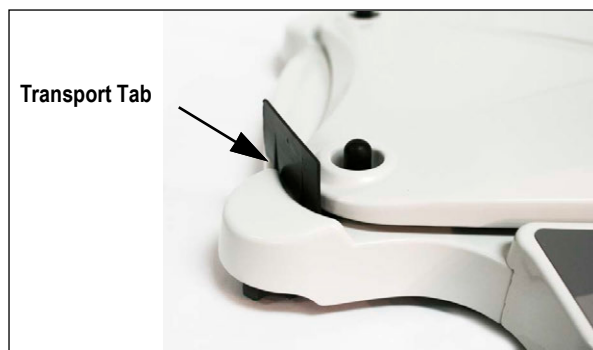

Figure 2-2. Support Tab Corners

3. The scale is equipped with four level adjusting feet. Rotate the adjustable feet located under the scale base to level the scale.
4. Place weighing tray on the base assembly ensuring it is securely resting on the four corner posts.

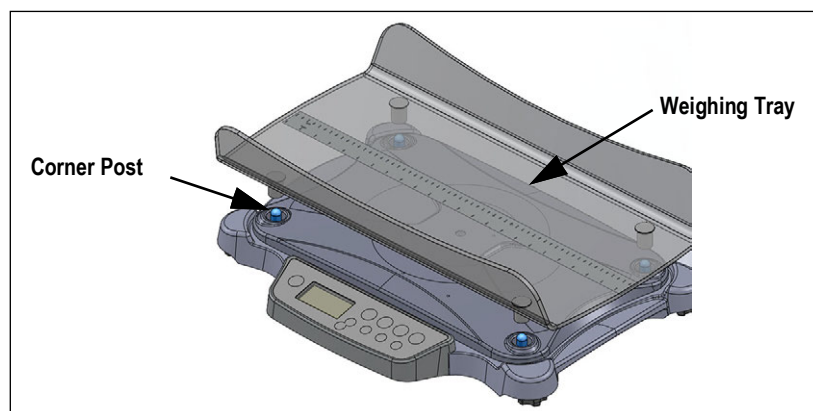

Figure 2-3. Attach Weighing Tray

3.0 Scale Configuration

Use the scale configuration to set up the scales parameters and options, that are essential for the functioning of the scale.

Access to the setup switch is located on the underside of the unit. Use a non-conductive object and gently press the internal setup switch.







Figure 3-1. Setup Switch Location

3.1 Menu Parameters

The measuring unit of the menu will be according to the measuring unit of the last calibration.

3.1.1 User Menu

1. Press  to turn the scale on, when START displays press and hold  until ID and firmware ID number flashes on the display.
2. Press . TEST displays.
3. Press  to enter menu or  to scroll to next parameter.



Parameter	Settings	Description
TEST		Test menu
	RID xxxxx	Internal ID number
	VER xx.xx	Development internal sub version
	A2D	Raw weight data
	VALUE	Processed weight in live display
	BAT	Raw bat value[BAT/16]
USER		Access some of the parameters from the PROG menu.
	BAUD	(96) - UART baud rate. Values: 48, 96, 144, 192, 288, 384, 576, 1152
	TOFF	(5) - Auto off timer in minutes (0 = Always on) - maximum 9 When using external power supply this parameter is irrelevant
	LIVE	(OFF) OP0 – Live weighing (0=Disable, 1=Enable, Default is Disable).
	MAIN	Communication protocol (0=ESC, 1=Maintenance, Default is ESC). Default – OFF
	OP1	SPACE (7) Number of new lines after print (hex: 0x0d 0x0a)
	SAVE	Programming done, parameters save to EEPROM.

Table 3-1. User Menu Parameters

Parameter	Settings	Description
GRAV		Gravity settings
	G-CAL	gravity at calibration location, read only
	G-LOC	gravity at user location GUPDAT <ul style="list-style-type: none"> • if ON, value can be updated; • if OFF, value is read only • after value is changed the first time, it is set to OFF.
RTC		??? (settings only displayed when option is on)
	Time	HH.MM set minutes, press enter, set hour
	Date	DD.MM set month, press enter, set day
	Year	YY set last two digits of year (example: 2017 enter 17)
DONE		Reboots scale

Table 3-1. User Menu Parameters (Continued)



3.1.2 Verification Menu

1. From ID display, press  to scroll to the verification menu.
2. Press  to enter the menu.

Parameter	Description and Settings
MONT	Set the next verification date in month. Default – 11 If set to zero no verification message (CNTL) will be displayed. On entering this menu will always show 11 month. The CNTL message is displayed on startup for 10 seconds
SAVE	Saving will indicate verification was done and the next verification date was saved.
DONE	Reboots scale after 3 seconds.

Table 3-2. Verification Menu Parameters

3.1.3 Maintenance Menu

1. From ID display, press the OnBoard key to scroll to the maintenance menu. The OnBoard key is under the keypad and has a seal on the opening.
2. Press  to change sub-menu and  to choose the required menu.
3. Press  to enter the menu.

Parameter	Description and Settings
PROG	Programming menu
CALIB	Calibration process
DEF	Load default menu, select Yes or No
DONE	Reboots scale

Table 3-3. Maintenance Menu Parameters

3.1.4 Programming Menu

Parameter	Default	Description and Settings
FULL	20 kg\40 lb	Full capacity*
LOAD	10 kg\20 lb	Calibration Load – can be changed from the calibration menu; max full capacity*
ASTART	0.030 kg\0.060 lb	Weight Process Start Limit – determines when weight algorithm starts (===== displays), below this value the scale displays live weight; max (full capacity)/10* Also used to determine manual or function tare on the 38 model.
ARW	0.050 kg\0.100 lb	Auto-Reweigh – restarts weigh algorithm if weight changes by more than set value; max full capacity*
SAL	0.005 Sec	Semi-Auto-Live – interval between weight displays during algorithm process; max 0.9 sec
ROUND	0.005 kg\0.010 lb	Scale resolution – Displays the high round if in dual range <ul style="list-style-type: none"> values in kg: 1, 1, 2, 5, 10, 20, 50, 100 values in lb: 1, 2, 5, 10, 20, 50, 100, 200 The decimal point location is set according to DISP parameter
BAUD	96	UART baud rate – settings: 48, 96, 144, 192, 288, 384, 576, 1152 Value entered is multiplied by 100 <i>example: 96 x 100 = 9600</i>
ATOL	2 0-255	Algorithm Initial Tolerance – if value is above 255, doesn't proceed and returns to previous value
ALEN	8 0-10	Algorithm Initial Exponent – if value is above 10, it returns to previous value
ATOUT	11 0-15	Algorithm Maximal Exponent – if value is above 15, it returns to previous value.
TOFF	5	Auto Off Timer 0-9 minutes (0 = always on) only applies when battery powered
TLOC	3	Auto Release Lock Timer – in seconds (0 = NO RELEASE, can have values from 0 to 9) Every x seconds the lock is released and the weighing algorithm restarts.
LANG	1	Print Language – 0 = English, 1 = French
SPACE	7	Number of new lines after print (hex: 0x0d 0x0a)
UNITS	kg\lb	Units of Measure displayed (kg, lb or kg\lb)
OP	--	Binary options: <ul style="list-style-type: none"> OP0 – Live weighing (0=Disable, 1=Enable, Default is Disable). OP1 – Communication protocol (0=ESC, 1=Maintenance, Default is ESC). OP2 – Reserved OP3 – RTC power (0=Disable, 1= Enable, Default is Enable). OP4 – SEMI-AUTO-LIVE (0=Disable, 1= Enable, Default is Enable). OP5 –full calculation (0= Spatial, 1=multiply by 2, Default is multiply by 2). OP6 – TARE (0=Disable, 1=Enable, Default is Enable). OP7 – BAT type (0=Dry batteries, 1= rechargeable batteries, Default is rechargeable). OP8 – OIML Mode (0=Disable, 1=Enable, Default is Enable). OP9 – USB boost (0= Disable, 1= Enable, Enable). OP10 – OZ display (0= Disable, 1= Enable, Disable). OP11 – Gravity Update - GUPDAT (0= Disable, 1= Enable, Disable). OP12 – Enable Print function - (0= Disable, 1= Enable, Disable).
SAVE	--	Press to save parameters to EEPROM (only displays if changes have been made)
DONE	--	Scale reboots

Table 3-4. Programming Menu Parameters

* The lb menu values will be multiplied by 2. (example: full 250.0 kg = 500.0 lb)

* The decimal point location is fixed in this program to 0.000

4.0 Calibration

Use the following steps to enter into the calibration mode and calibrate the unit.







1. Press and hold  and then press  until ID is displayed.
2. Using a non-conductive instrument, press the setup switch located under the unit. PROG displays.









Figure 4-1. Setup Switch Location

3. Press the left arrow until CALIB is displayed.
4. Press .
5. Use  or  to select 20 lb or 10 kg.



NOTE: If using a different weight value other than those listed in Step 5, press  again and the far right digit flashes. Press the up or down arrows to change the weight value. The left arrow moves to the next digit on the left, allowing changes to the value.

6. Press  to save that weight value. CLEAR displays.
7. Make sure the platter is empty and press . ===== displays.
8. PUT is displayed. Put the entered value (ie: 20 lb) onto the platter. ===== displays.
9. Press . The scale calibrates that weight. Once calibrated, SAVE is displayed.
10. Press . The scale displays DONE.
11. Press  so goes back to DONE, then press . The scale reboots and returns to weigh mode.

5.0 RS-232 Communication

The scale comes with an RS-232 port which enables weight data to be transmitted to other equipment, such as a computer or printer. The RS-232 cable with DB-9 connector (PN 100719) is available from Rice Lake Weighing Systems. [Figure 5-1](#) shows where the RS-232 connection is.

The RS-232 parameters are 9600 baud (selectable in the programming mode), 8 data bits, 1 stop bit, no parity and no handshaking.

The method to access weight data from the computer is:

- Pushbutton keypad print - Done by pressing and holding the REWEIGH key.

5.1 Pushbutton Keypad Print

With a stable, in-range weight, press and hold the REWEIGH key for at least three seconds. Note that if the scale does not beep after five seconds, then release the button as the weight was either in motion, or out of range. The print will show on the display when it is transmitting data.

If displaying weight, the scale will send out the following 21 character string:

```
xxxxxxxx<SP>uu<SP>mmmmm<SP><CR><LF>
```

Where:

xxxxxxxx is the weight with decimal point and (-) neg sign, if negative uu is the unit (lb or kg).

mmmmm is the mode (gross or net)

Examples:

```
-10 Lb net = <SP><SP><SP><SP>-10.0<SP>lb<SP><SP>Net<SP><SP><SP><CR><LF>
```

```
10 Lb gross = <SP><SP><SP><SP><SP>-10.0<SP>lb<SP>Gross<SP><CR><LF>
```

5.2 USB Connection

The 650-10-1 Neonatal Scale has the capability of connecting to a PC using a USB connection and a USB cable. That connection location is shown in [Figure 5-1](#).

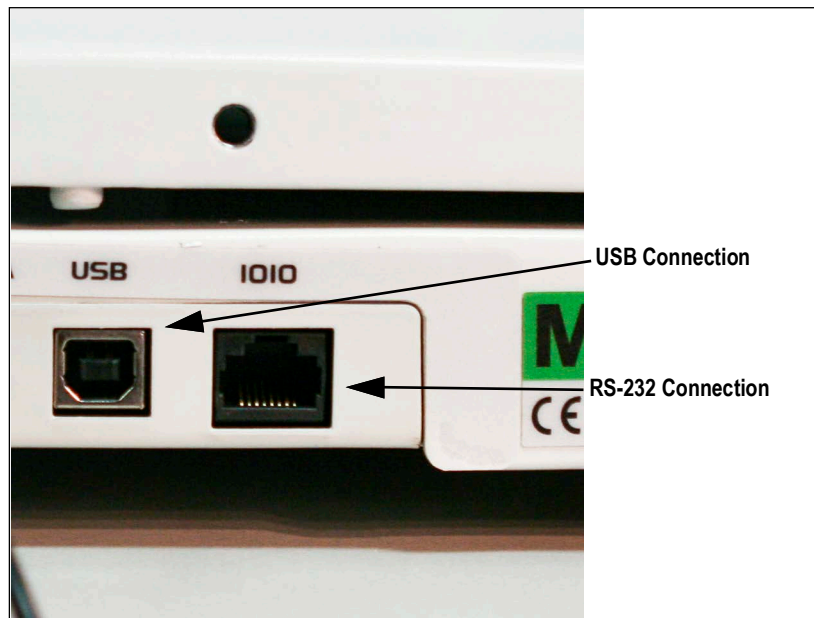

Figure 5-1. USB Connection Port and RS-232 Connection Port

Connecting software and downloads should be addressed by an IT professional, and can vary depending on the computer platform used. Basic information on USB driver installation using Windows® is described in the following steps and serves only as an example.

A USB driver can be downloaded from the Rice Lake Weighing Systems website at:

<https://www.ricelake.com/resources/software-firmware>

1. Search for Titanium USB Driver.



Figure 5-2. Software/Firmware Page

2. Click on Download to open and download the driver to a local computer.
3. When the USB cable is connected to the indicator and the scale is turned on, a display prompts to navigate through the software install process.



Figure 5-3. Hardware Wizard Menu

4. Select No, not this time, and then click Next.
5. Select Install the Software Automatically, then select Next. A file transfer screen displays as the file downloads and installs to the computer.
6. Click Finish when the completion screen displays.

- To verify the installation, view the driver by looking at the device manager of the system.

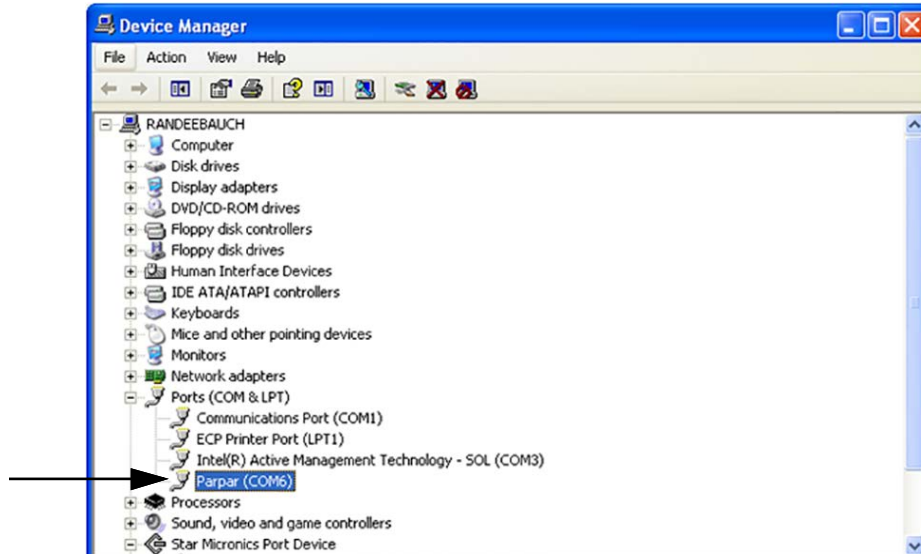



Figure 5-4. Device Manager

- To configure a printer using the USB driver, open the software driver Parpar in the device manager (Figure 5-4). The port assigned to that driver is displayed.
- Ensure the USB cable is properly connected and the unit is on.
- Open and connect a terminal emulation program, such as Hyperterminal, via the USB driver. Select the port assigned to the software driver Parpar to establish a port. The terminal emulation program is necessary to view information transmitted from the indicator to the PC.
- Press . The following example tickets print.

```
PATIENT WEIGHT 199.8 lb

GROSS WEIGHT      199.8 lb
TARE WEIGHT        0.0 lb
NET WEIGHT         199.8 lb
PATIENT HEIGHT    6ft 00.0in
PATIENT B.M.I     27.1
```

Figure 5-5. Example Tickets



NOTE: A single print ticket has four spaces after the “patient weight” and only one space between weight and lb in the examples shown above. Then seven <CR><LF> after.

```
PATIENT WEIGHT 199.8 lb <CR><LF>
<CR><LF>
<CR><LF>
<CR><LF>
<CR><LF>
<CR><LF>
<CR><LF>
```

Figure 5-6. Example Tickets



IMPORTANT: Figure 5-6 is for IT information only. The tickets print as in Figure 5-5.

6.0 Troubleshooting and Maintenance

6.1 Troubleshooting & Testing

Refer to the following instructions to check and correct any failure before consulting service personnel.

Symptom	Possible Cause	Corrective Action
Scale does not turn on when using just batteries	Dead batteries	Connect the scale to a power source or change batteries
Scale does not turn on	Dead battery	Connect the scale to a power source
	Faulty electrical outlet	Use a different electrical outlet
	Bad power supply	Replace optional adapter
Questionable weight or the scale does not zero	External object is interfering with the scale	Remove the infant/interfering object from the weighing tray from the scale
	Display did not show 0.0 before weighing	Remove the infant, zero the scale and begin the weighing process again
	Scale is not placed on a level surface	Place the scale on a stable surface and begin the weighing process again
	The weighing tray is not placed properly	Place the weighing tray in its proper place
	Scale is out of calibration	Check the scale with a known weight value
The display shows o_Ld message	The load on the scale exceeds the capacity	Remove the excess weight and use the scale according to its stated limit
The display show Err	The RECALL key was pressed with insufficient weight on the scale.	Place more than 2 lb, 30 oz on the scale

Table 6-1. Troubleshooting Table

6.2 Maintenance

The following section provides instructions for maintaining and cleaning the 650-10-1 Neonatal Scale. Maintenance operations other than those described in this section should be performed by qualified service personnel.

6.2.1 Basic Maintenance

Before the first use of the scale and after periods of non-use, check the scale for proper operation and function. If the scale does not operate correctly, contact qualified service personnel.

Go through the following steps for basic maintenance:

1. Check the overall appearance of the entire scale for any obvious signs of damage, abuse, etc.
2. Inspect the condition of the optional AC adapter for cord cracking or fraying, or for broken or bent prongs.

6.2.2 Cleaning

Proper care and cleaning is essential to ensure a long life of accurate and effective operation.



WARNING: Before beginning the cleaning process, disconnect the scale from the AC power source.

Clean all external surfaces with a clean, damp cloth or tissue. Mild soap and water solution may be used. Dry with a clean soft cloth.



IMPORTANT: Do not immerse the scale into cleaning or other liquid solutions.

Do not use Isopropyl alcohol or other solutions to clean the display surface.

7.0 Specifications

Capacity:

Range 1: 0 to 10 lb × 0.05 oz (0 to 5 kg × 1 g)

Range 2: 10 to 33 lb × 0.1 oz (5 to 15 kg × 2 g)

Power:

12 VDC, provided by six AA lithium batteries (included) or AC adaptor (optional)

Measuring Tape:

0 to 23.5 in × 0.125 in

(0 to 60 cm × 0.25 cm)

Battery Type:

Six Li-FeS₂ batteries

Operating Temperature:

50 °F to 95 °F (10 °C to 35 °C)

Display:

5-digit LCD display, 0.75 in (1.9 mm) digit height

Warranty:

Two-year limited

Approvals:



E113986