

champion.



T4

# OWNER'S OPERATING AND MAINTENANCE MANUAL

T4 and T4-X PROCEDURE CHAIR

champion.

---



## IMPORTANT

**READ AND FAMILIARIZE YOURSELF WITH ALL INSTRUCTIONS BEFORE USING THIS PRODUCT!**

**Do NOT install, maintain or operate this equipment without reading and following this manual, otherwise injury and/or damage may result.**

**IF YOU HAVE ANY QUESTIONS OR CONCERNS, PLEASE CONTACT CHAMPION MANUFACTURING, INC.**

**Champion assumes no responsibility for damage or injury caused by improper assembly, installation, use, or maintenance of these products.**

**No part of this manual may be duplicated in any form without the prior consent of Champion Manufacturing, Inc. Unauthorized duplication/distribution of these materials may result in civil prosecution to the maximum extent allowed by law.**

**The information contained in this manual is subject to change without notice.**

**SAVE THESE INSTRUCTIONS FOR FUTURE REFERENCE!**

**These instructions are available online at no charge.**

**Visit [ChampionChair.com](http://ChampionChair.com) to download.**

## SYMBOLS

	FOLLOW INSTRUCTIONS		GENERAL WARNING/DANGER IEC 60601-1:2012 EDITION 3.1 AND ISO 7010:2019-W001
	PINCH-POINT WARNING		IEC 60417-5840 TYPE B APPLIED PART
	COMPLIES WITH AUSTRALIAN SAFETY/ EMC REGULATIONS		IEC 604417-5172 CLASS II EQUIPMENT
	RECOGNIZED COMPONENT MARK FOR CANADA AND THE UNITED STATES		ELECTRONICS SCRAP
	COMPLIES WITH EU MDR 2017/745		UK CONFORMITY ASSESSMENT
	RECOGNIZED COMPONENT MARK FOR CANADA AND THE UNITED STATES		CAUTION ISO 15223-1:2021

### Your T-Series Procedure Chair is certified to:

ANSI/AAMI ES60601-1:2005+A1:2012+A2:2021

IEC 60601-1-6:2010+AMD1:2013+AMD2:2020

CAN/CSA-C22.2 No. 60601-1:08+A1:14+A2:22

CAN/CSA-C22.2 NO. 60601-1-6:11+A1:2015+A2:21 (R2021)

# TABLE OF CONTENTS

Important Notes about this Manual.....	2
Intended Use Statement.....	4
Transportation, Storage, Handling & Disposal.....	4
Preparation: Before You Begin.....	4
Specifications.....	5
Power Cable Requirements.....	6
Safety Precautions.....	6
Product Labeling Diagrams (T4 Shown).....	11
Pinch Points.....	12
Operating Instructions.....	13
Quick Release Back Section.....	13
Caster Brake Operation.....	14
Side Rail Operation.....	15
Adjusting Side Rail Angle.....	15
Pendant (Controller).....	16
Control Box Indicator Lights.....	19
Patient Ingress/Egress.....	21
Patient Transfer.....	21
Push Bar Operation.....	22
Batteries.....	22
Options.....	23
“W” Option: Wide Width.....	23
“L” Option: Low Height.....	23
“F” Option: Folding Footrest.....	23
“Q” Option: Scale.....	24
Footswitch Accessory.....	25
Cleaning Instructions.....	26
Pad Removal Instructions.....	28
Preventive Maintenance.....	29
Battery Safety & Charging Information.....	30

# INTENDED USE STATEMENT

The T4 Procedure Chair is intended to provide a support surface to position patients, excluding infants, for treatment, examination, recovery, and transport in the surgical and emergency healthcare settings.

This device is battery powered and employs a pendant control to operate a series of electric motors for patient positioning. The pendant control is **NOT INTENDED FOR PATIENT USE**.

A surgeon and/or clinician must always rely on his or her own clinical knowledge when deciding whether to use a T4 Procedure Chair when treating a patient.

Use of the product for an extended duration by patients with pre-existing, or at high risk for, decubitus ulcers is contraindicated.

# TRANSPORTATION, STORAGE, HANDLING & DISPOSAL

- The product should be transported in factory packaging, inside an appropriate medium for the destination, i.e., air/sea cargo containers.
- The product should be stored and transported in the following conditions: 14°F (-10°C) to 122°F (50°C).
- Champion Manufacturing, Inc. recommends not leaving the product in the factory packing in excess of three (3) months.
- The product should always be handled in a manner consistent with the user instructions and in a manner to prevent contamination after each use.
- The product has many recyclable components and to the extent practical, all effort should be used to recycle responsibly. Otherwise the product components shall be disposed of in accordance with local statutes.

# PREPARATION: BEFORE YOU BEGIN

1. Carefully examine your product for any damage. Be sure to inspect all components.  
**IF DAMAGE IS EVIDENT, CONTACT FREIGHT CARRIER OR CHAMPION IMMEDIATELY.**
2. Remove all packaging material and any hardware that was secured for shipping.
3. Carefully remove all components and any included tools and/or parts from the carton.
4. You may need to cut packaging materials with a box cutter or scissors to access the product. Use **CAUTION** to avoid personal injury or damage to the product.
5. Save all boxes and packaging material until **AFTER** you have assembled your product and have verified that all components are functioning properly. These materials are required if it becomes necessary to return the product.
6. **DO NOT** install, maintain or operate this equipment without reading and following this manual otherwise injury and/or damage may result. **If you have questions or concerns please contact Champion Manufacturing, Inc.**

**CHAMPION ASSUMES NO RESPONSIBILITY FOR DAMAGE OR INJURY CAUSED BY IMPROPER ASSEMBLY, INSTALLATION, USE, OR MAINTENANCE OF THESE PRODUCTS.**

## SPECIFICATIONS

Procedure Chairs	T4-XB	T4-B	T4-LB	T4-WB
Wheelbase (length x width)	33" x 20" (84 cm x 51 cm)	30" x 20" (76 cm x 51 cm)	30" x 20" (76 cm x 51 cm)	30" x 20" (76 cm x 51 cm)
Weight Capacity	500 lbs. (227 kg)	500 lbs. (227 kg)	500 lbs. (227 kg)	500 lbs. (227 kg)
Seat Height, (low ♦ high)	23.5" ♦ 43.5" (60 cm ♦ 110 cm)	23.5" ♦ 43.5" (60 cm ♦ 110 cm)	22" ♦ 42" (56 cm ♦ 107 cm)	23.5" ♦ 43.5" (60 cm ♦ 110 cm)
Back Width	24" (61 cm)	24" (61 cm)	24" (61 cm)	28" (71 cm)
Side Rail Height (up, seat pan to rail top ♦ Length)	13.5" ♦ 27.5" (34 cm ♦ 70 cm)	13.5" ♦ 27.5" (34 cm ♦ 70 cm)	13.5" ♦ 27.5" (34 cm ♦ 70 cm)	13.5" ♦ 27.5" (34 cm ♦ 70 cm)
Overall Chair Height, (low ♦ high)	56" ♦ 76" (142 cm ♦ 193 cm)	56" ♦ 76" (142 cm ♦ 193 cm)	54.5" ♦ 74.5" (138 cm ♦ 189 cm)	56" ♦ 76" (142 cm ♦ 193 cm)
Seat Width	24" (61 cm)	24" (61 cm)	24" (61 cm)	28" (71 cm)
Overall Width (rails up)	31" (79 cm)	31" (79 cm)	31" (79 cm)	35" (89 cm)
Patient Surface Length (standard ♦ with optional manual folding footrest)	77" ♦ 71" (196 cm ♦ 180 cm)	77" ♦ 71" (196 cm ♦ 180 cm)	77" ♦ 71" (196 cm ♦ 180 cm)	77" ♦ 71" (196 cm ♦ 180 cm)
Backrest Articulation Range	0° – 90°	0° – 90°	0° – 90°	0° – 90°
Trendelenburg	20° ♦ 5° Reverse	5° ♦ 0° Reverse	5° ♦ 0° Reverse	5° ♦ 0° Reverse
Charging System Input Volts	120-240 VAC	120-240 VAC	120-240 VAC	120-240 VAC
Charging System Current	350 mA	350 mA	350 mA	350 mA
Charging System Frequency	50/60 Hz	50/60 Hz	50/60 Hz	50/60 Hz
Charging System Max Power	38.5 W	38.5 W	38.5 W	38.5 W

## ELECTRICAL SPECIFICATIONS

Input Voltage: 120-240VAC (50/60 Hz)

Power consumption (standby) max. 0.5 W (depending on input voltage)

Power consumption (charging) max. 30 W (depending on input voltage)

## DUTY CYCLE

10%, Max / 2 min, MIN / 18 min

## IP RATING

All T4 Procedure chairs are rated IPX0

# POWER/CABLE REQUIREMENTS

Only use the power/charging cord that came with your product.

## SAFETY PRECAUTIONS



**WARNING**

**IMPORTANT: PLEASE READ**

## WARNINGS

### CHAIR OPERATION BY QUALIFIED, TRAINED MEDICAL PERSONNEL ONLY

The chair is intended to be operated only by qualified, trained medical staff. Operation of chair by unauthorized, untrained and/or lay people must be avoided.

### USE CAUTION ON RAMPS

Control chair when traversing ramps. If a collision occurs, serious injury to patient, bystanders, or medical personnel and damage to chair or medical facility could occur.

### LOCK CASTERS BEFORE PATIENT EGRESS/INGRESS

Prior to patient egress / ingress, casters must be locked by depressing red tab completely down on either left- or right-side brake pedal.

### AVOID PINCH POINTS AND OTHER INJURIES

To prevent serious injury, ensure extremities of patient and bystanders are clear of all mechanical systems when operating motors for lift and positioning functions.

To prevent pinch/crush injury, ensure extremities of patient and bystanders are clear of locking mechanism when raising and lowering side rails.

To prevent patient strangulation, use approved hand pendant storage location when not in use. See PENDANT section for additional information.

### BATTERY CAN EXPLODE DUE TO OFF-GASSING WHEN CHARGING

At end of charging process (or with overcharge conditions), battery can produce mixture of explosive gases (Including hydrogen and oxygen). Avoid exposing battery to open flames, cigarettes, sparks, and Incandescent materials.

Never charge battery in enclosed, unventilated spaces.

Do NOT store battery in sealed container. Store in fresh, well-ventilated area protected from direct sunlight and heat sources.

Do NOT use water to extinguish battery fire. Use dry powder, foam CO<sub>2</sub> extinguisher.

Do not leave the AC mains cord attached to the control box when a battery is not installed. Exposed contacts on the control box may present a mild shock hazard under certain conditions.

# SAFETY PRECAUTIONS CONTINUED



## WARNING

## IMPORTANT: PLEASE READ

### USE CAUTION WHEN STORING OXYGEN CYLINDER UNDER CHAIR

To prevent severe gas leakage or rupture of compressed gas cylinder, when placing cylinder under chair, ensure adequate clearance between cylinder and its attached gas equipment (i.e. regulator, gauges, fittings, knobs) and all adjustable chair sections and/or features (i.e. seat, back, leg, rails, actuators).

To prevent fire and/or explosive hazard, do not leave chair (and stowed oxygen equipment) near heat source.

To prevent gas equipment damage during transport, ensure cylinder sets in cradle properly and strap mechanisms are secured tightly. Chair is intended to accommodate up to an E-size cylinder (4 3/8" outer diameter x 25" length).

### DO NOT PLACE EXCESSIVE WEIGHT ON ENDS

Position patient's body weight uniformly over the patient surface. Use caution when shifting patient's body weight towards either end of the Procedure-Chair. Excessive weight on either end of the device could cause the Procedure-Chair to become unstable.

Do not sit or stand on the ends of the Procedure-Chair. Instruct patients to not stand on footrest during egress or ingress.

Due to the unique nature of each patient's body shape, caregiver should exercise sound judgment when positioning patient on the device.

## ACCESSORY WARNINGS

- To prevent serious injury and property damage, review Operating Manuals for all medical equipment and accessories that may be used with, or attached to, this chair.
- Using the supplied accessories in the incorrect manner may cause patient, bystander, or facility harm.
- If chair is equipped with accessory belts, refer to the appropriate Field Installation and Usage Instructions (provided with belts) for proper installation, use, and care.
- To prevent fire hazards, follow all precautions and operating procedures prescribed by suppliers of oxygen administering equipment (i.e. oxygen gas regulators, tents, masks, cannulas, etc.)
- To prevent injury and property damage, total weight of items placed on IV pole must be less than 25 pounds.
- If mounting accessories to back surgical rails, ensure accessory is properly installed and securely engaged prior to transporting patient or chair and prior to use. Only equipment approved by Champion is to be mounted on surgical rails. Champion Manufacturing, Inc. is not responsible for damage and assumes no liability caused by the use of unapproved equipment or accessories. Approved medical equipment includes tools, instruments, or scopes that are compatible with a 0.365" thick by 1.125" wide surgical rail.

# SAFETY PRECAUTIONS CONTINUED



## CAUTION

## IMPORTANT: PLEASE READ

## CAUTIONS

### DO NOT MODIFY CHAIR

Modifying chair can cause unpredictable operation resulting in injury to patient, medical personnel, or bystander. Modifying chair will void warranty and may cause unsafe operating conditions. **Do not perform service or maintenance on any part of the chair while occupied by a patient.**

### USE SAFE OPERATING PROCEDURES

Prior to operating chair, ensure patient clearance by moving any overhanging equipment or moving chair from under a table to prevent patient injury.

For T4, chair must be at least 24 inches from nearest wall or obstruction to allow for full range of activation.

Leave chair in lowest position whenever possible. This practice will decrease potential injury during an unsupervised patient egress from chair.

Prior to patient transport in chair, raise side rails and ensure latching mechanism is in locked position. Medical personnel must determine degree of restraint needed to ensure patient's safety during transport.

For "F" Option Only: Since footrest is foldable (not locked in position), ensure protection of patient's feet while moving chair in close quarters (i.e. elevators, crowded hallways, procedure rooms).

### INSPECT AND CLEAN CHAIR REGULARLY

Inspect cushions after each use. Discontinue use if upholstery is ripped, cut, or torn, which could allow fluids to enter cushion. This practice will prevent infection of patients and medical personnel and contamination of medical equipment.

Do NOT use machine/pressure/power wash procedures on chair. After each use in a clinical setting, hand wash all patient-contact surfaces (i.e. cushions, rails) and plastic base cover with warm water and mild detergent.

### MAXIMUM WEIGHT OF BACK SURGICAL BAR

The maximum weight capacity of each back surgical bar is 50 pounds. To prevent personal injury to patient, do not mount equipment weighing more than 50 pounds to device. Weight of patient plus weight of equipment should not exceed 500 pound weight capacity of the procedure chair.

### POWER

To disconnect all power from the chair, remove the battery and verify the power cord is not attached to the control box.

## EMI CAUTIONS

### EMI MAY AFFECT CHAIR FUNCTIONALITY

The EMISSIONS characteristics of this equipment make it suitable for use in industrial areas and hospitals (CISPR 11 class A). If it is used in a residential environment (for which CISPR 11 class B is normally required) this equipment might not offer adequate protection to radio-frequency communication services. The user might need to take mitigation measures, such as relocating or re-orienting the equipment.

# SAFETY PRECAUTIONS CONTINUED



## CAUTION

## IMPORTANT: PLEASE READ

Chair may be susceptible to EMI (Electromagnetic Interference) caused by electromagnetic energy emitted from various sources, such as, radio and television stations, amateur radio (HAM) transmitters, citizen band (CB) radios, hand-held “walkie-talkies”, security/police/fire transceivers and other communication devices. EMI can cause the chair to move by itself, or in an unintended fashion, and can damage control systems.

**CAUTION:** Use of this equipment adjacent to or stacked with other equipment should be avoided because it could result in improper operation. If such use is necessary, this equipment and the other equipment should be observed to verify that they are operating normally.

**CAUTION:** Use of accessories, transducers, and cables other than those specified or provided by Champion could result in increased electromagnetic emissions or decreased electromagnetic immunity of this equipment and result in improper operation. The AC power cable supplied with your chair is 3,000 mm long (+/- 300 mm). The pendant cable is 820 mm long coiled and 7,400 mm long uncoiled. If equipped, the scale pendant cable is 32” long coiled, and 288” long uncoiled.

**CAUTION:** Portable RF communications equipment (including peripherals such as antenna cables and external antennas) should be used no closer than 30 cm (12 inches) to any part of your TMM Procedure Chair, including cables specified by Champion. Otherwise, degradation of the performance of this equipment could result.

Your Procedure Chair has been tested and certified to IEC/EN 60601-1-2:2020.

TEST TYPE	STANDARD	TEST LEVELS
Radiated Emissions	CISPR 11	Class B Group 1, 30 - 1000 MHz
Conducted Emissions	CISPR 11	Class B Group 1, 150 kHz - 30 MHz
Harmonic Current Emissions	IEC 61000-3-2	Class A
Voltage Fluctuation	IEC 61000-3-3	Class A
Electrostatic Discharge Immunity	IEC 61000-4-2	±2, 4, 8, 15 kV Air Discharge ±8 kV Contact Discharge
Radiated Electromagnetic Field Immunity	IEC 61000-4-3	3 V/m, 80 - 1000 MHz, 80% 1 kHz AM Modulation 3 V/m, 1 - 2.7 GHz, 80% 1 kHz AM Modulation
Proximity Fields from RF Wireless Communications Equipment	IEC 61000-4-3	See Table Below
Electrical Fast Transient /Burst Immunity	IEC 61000-4-4	± 2 kV on AC Mains 100 KHz Repetition Rate
Surge Immunity	IEC 61000-4-5	±2 kV, Line-Gnd ±1 kV, Line-Line
Conducted Immunity	IEC 61000-4-6	3 Vrms, 0.15 - 80 MHz , 6 Vrms ISM Bands, 80% 1 kHz AM Modulation
Power Frequency Magnetic Field Immunity Test	IEC 61000-4-8	30 A/m @ 60 Hz
Proximity Magnetic Fields Immunity Test	IEC 61000-4-39	134.2 kHz @ 65 A/m; 2.1 kHz PM; 13.56 MHz @ 7.5 A/m; 50 kHz PM
Voltage Dips Voltage Interruptions	IEC 61000-4-11	0%, 1 periods (20 ms) 0%, .5 periods (10 ms) 70%, 25 periods (500 ms) 0% 250 periods (5 sec)

**TEST SPECIFICATIONS FOR ENCLOSURE PORT IMMUNITY TO RF WIRELESS COMMUNICATION EQUIPMENT**

Test Frequency (MHz)	Band (MHz)	Service	Modulation	Test Level (V/m)
385	380 to 390	TETRA 400	Pulse Modulation, 18 Hz	27
450	430 to 470	GMRS 460, FRS 460	FM ± 5 kHz deviation 1 kHz sine	28
710				
745	704 to 787	LTE Band 13, 17	Pulse Modulation, 217 Hz	9
780				
810				
870	800 to 960	GSM 800/900, TETRA 800, iDEN 820, CDMA 850, LTE Band 5	Pulse Modulation, 18 Hz	28
930				
1720				
1845	1700 to 1990	GSM 1800; CDMA 1900; GSM 1900; DECT; LTE Band 1, 3, 4, 25; UMTS	Pulse Modulation, 217 Hz	28
1970				
2450	2400 to 2570	Bluetooth, WLAN, 802.11 b/g/n, RFID 2450, LTE Band 7	Pulse Modulation, 217 Hz	28
5240				
5500	5100 to 5800	WLAN 802.11 a/n	Pulse Modulation, 217 Hz	9
5785				

## IMPORTANT

### MAXIMUM PATIENT WEIGHT IS 500 lbs (227 kg)

Maximum patient weight capacity of chair is 500 pounds. If exceeded, damage to chair could occur.

### CHAIR IS INTENDED FOR INDOOR USE ONLY

To ensure proper operation and extend chair life, only use the chair in the following conditions:

- Temp – 41 °F to 104 °F (+5 °C to +40 °C)
- Relative Humidity – 20% to 80% non-condensing
- Atmospheric Pressure: 700 to 1060 hPa
- Elevation: Max. 9,842 ft (3,000 meters)

### USE CDC'S UNIVERSAL PRECAUTIONS

When maintaining chair after clinical use, service personnel must use UNIVERSAL PRECAUTIONS as defined by CDC (Centers for Disease Control and Prevention).

## MAINTAIN CHAIR REGULARLY

To ensure proper operation and extend chair life, inspect, maintain, and service chair on a regular basis. Inspection, maintenance, and service details are located later in this manual.

## REMOVE BATTERY DURING CHAIR STORAGE

If chair is to be stored or not in use for 6 months or more, remove battery pack from chair.

## USE ONLY FACTORY APPROVED BATTERIES

Use of unapproved batteries will void warranty. Replace only with Champion part number TMA300-15.

# PRODUCT LABELS/DIAGRAMS (T4 SHOWN)



## CAUTION

## INSPECT LABELS PERIODICALLY

Every three (3) months, inspect all labels and ensure they are legible and not tattered, torn or missing. Refer to the label locations in figure below. If labels need replacing, contact Champion Customer Service at 1-800-237-3377.



Item No.	Part No.	Description	Qty
8	TMM-2543-10	T4 Base Cover Label (side)	2
7	TMM-2448-10	Label Base Cover	1
6	TMM-754-10	Max Weight Label 500 lb	1
5	TMM-684-10	Cover Clearance Caution Label (X-Models Only)	1
4	TMM-214-10	Product Label – Small	2
3	TMM-207-10	Backrest Quick Release Label	1
2	TMM-205-10	Aluminum Equivalency Label	1
1	TMM-2535-10	Chair End Warning Label	4

## PINCH POINTS



# OPERATING INSTRUCTIONS

## QUICK RELEASE BACK SECTION

### 1. LOCATE RELEASE LEVER

Back section quick release (red) lever is located under seat on patient's right side. (Fig. 1)



### 2. ACTIVATE RELEASE LEVER

To activate back section quick release, pull red lever out towards the arm rail. When weight is applied, back section will drop until lever is released. (Fig. 2)



**NOTE:** Quick release feature is intended for emergency purposes only.



## WARNING

**PRIOR TO PERFORMING CHEST COMPRESSIONS ON A PATIENT, FIRST AND FOREMOST, THE PATIENT SHOULD BE MOVED TO A MORE STABLE, NON- PADDED PLATFORM. SECONDARILY, IF ATTEMPTING TO PERFORM CHEST COMPRESSIONS ON THE DEVICE, THE PATIENT SHOULD BE PLACED ON A BACK BOARD AND POSITIONED ON THE CHAIR SO THE PATIENT'S CHEST CAVITY IS OVER, OR AS CLOSE TO, THE COLUMN SUPPORT AS POSSIBLE. IT IS THE RESPONSIBILITY OF THE MEDICAL PROFESSIONAL TO DETERMINE WHETHER CPR CAN BE EFFECTIVELY PERFORMED ON THIS CHAIR ON A CASE-BY- CASE BASIS.**

**NOTE:** To ensure proper operation, activate quick release every thirty days. If quick release does not operate properly, please contact Customer Service at 1-800-237-3377.

# CASTER BRAKE OPERATION

## BRAKE MODE

Activate braking system by pressing down on red end of either brake pedal located at base of chair. (Fig. 1)

**NOTE: This mode prevents all four casters from swiveling and all wheels from spinning.**

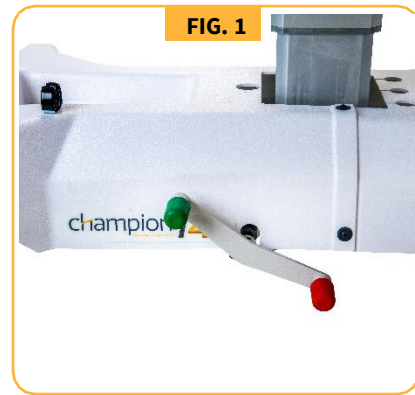

## NEUTRAL MODE

Activate neutral mode by placing either brake pedal into a horizontal orientation. (Fig. 2)

**NOTE: This mode allows all four casters to swivel and all wheels to spin freely.**



## STEER MODE

Activate steer-locking system by pressing down on green end of either brake pedal located at base of chair. (Fig. 3)

**NOTE: This mode locks caster (near patient's right foot) parallel to base, but allows this wheel to spin. Other three casters swivel, and wheels spin freely.**



Before activating steer mode, verify the front right caster is TRAILING the pivot (fig a), not LEADING the pivot (fig b)



# SIDE RAIL OPERATION

## LOWERING SIDE RAIL

Grasp top of side rail and push inward slightly, while pulling out red rail release tab. Once released, lower rail. (Fig. 1)



## STOWING SIDE RAIL

To stow side rail, lower rail into “down” position below seat (or back section depending on rail location). (Fig. 2)



## RAISING SIDE RAIL

Lift side rail until it is in “up” position.

**NOTE:** Red rail release tab will engage (lock) automatically. Ensure side rail is secure by pulling on rail after it is raised.

# ADJUSTING SIDE RAIL ANGLE

1. Remove seat cushion to expose access holes in seat pan.
2. Loosen top jam nut found in access holes (Fig. 1 & 2) (Seat pan is not shown in image for instruction purposes only and to allow visibility of jam nut).
3. To move inward, rotate bottom jam nut as shown (Fig. 3).
4. To move outward, rotate bottom jam nut as shown (Fig. 4).
5. Once aligned (Fig. 5), tighten top jam nut.

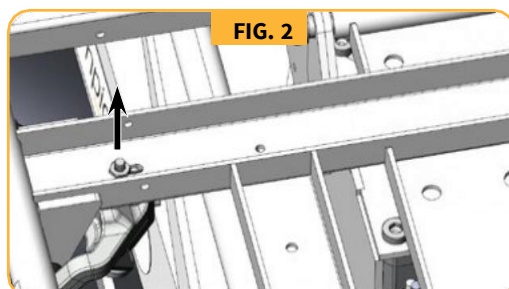
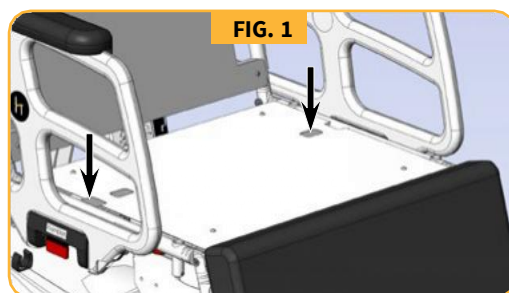

**IMPORTANT**

- You do not need to hold the bottom nut while tightening the top nut.
- When adjusting, ensure bottom jam nut is contacting seat frame.
- Ball joint head angle does not matter.
- Prior to adjustment, pull outward on side rail in order for system to settle.
- Ensure top jam nut engages at least two full threads.
- Do not over tighten top jam nut (there is no need).

6. Reattach seat pan and cushion.

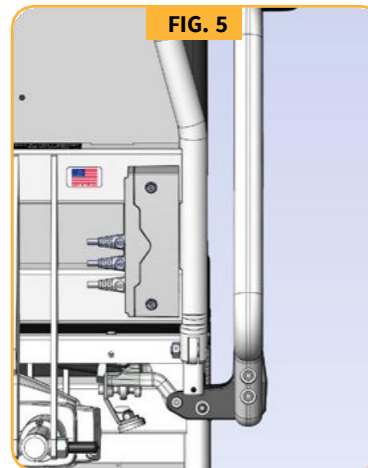
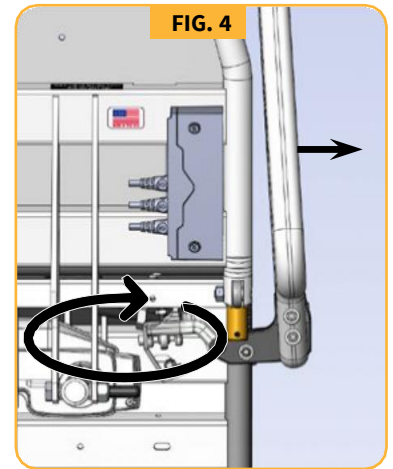
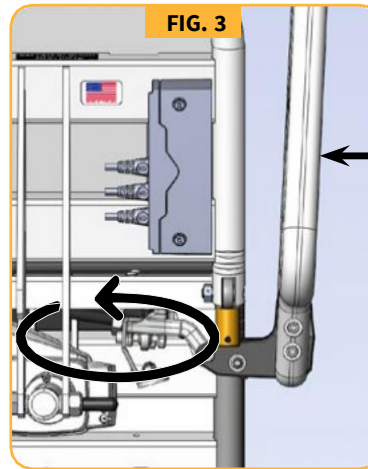
**PENDANT (CONTROLLER)****PENDANT IS NOT INTENDED FOR PATIENT'S USE****CAUTION**

To prevent damage, pendant can be stored at various locations on the chair when not in use.

**ENSURE AREA IS CLEAR OF OBSTRUCTIONS PRIOR TO PENDANT USE****WARNING**

To prevent property damage or injury to patient, survey area for possible obstructions prior to pendant use.



# PENDANT (CONTROLLER)

## BACK SECTION ADJUSTMENT

First row of pendant buttons adjusts angle of back section.

- Press left button to raise chair back.
- Press right button to lower chair back.

## LEG SECTION ADJUSTMENT

Second row of pendant buttons adjusts angle of leg section.

- Press left button to raise chair's leg section.
- Press right button to lower chair's leg section.

## SEAT HEIGHT ADJUSTMENT

Third row of pendant buttons adjusts height of seat section.

- Press left button to raise chair's seat.
- Press right button to lower chair's seat.

## SIMULTANEOUS LEG AND BACK SECTION (AUTO CONTOUR) OPERATION

Fourth row of pendant buttons controls simultaneous actuation of leg and back sections.

- Press left button to raise chair's leg section and lower chair's back, resulting in stretcher configuration.
- Press right button to lower chair's leg section and raise chair's back, resulting in chair configuration.

## SEAT TILT/TRENDELENBURG ADJUSTMENT (FOR "X" MODEL ONLY)

Fifth row of pendant buttons controls the seat section incline/recline or Trendelenburg/reverse Trendelenburg position depending on chair.

- Press left button to raise front of seat section (Trendelenburg in Stretcher position).
- Press right button to lower front of seat section (Reverse Trendelenburg in Stretcher position).

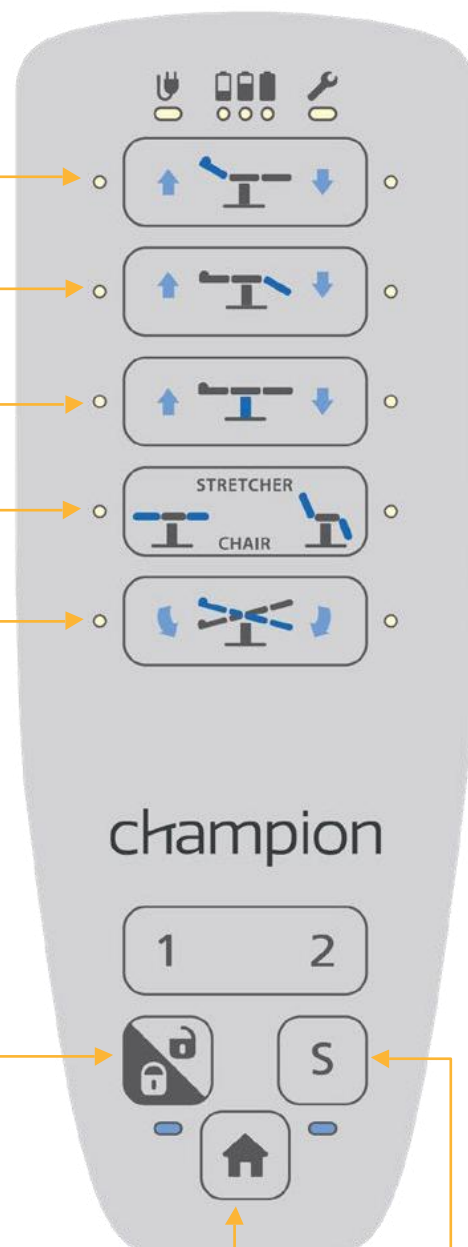

### LOCK FUNCTION

Press and hold, then press another button to lock that function

### MEMORY PRESET

Press once, then choose 1 or 2 to save that position

### HOME

Press and hold to return to HOME position

### TO SET HOME POSITION



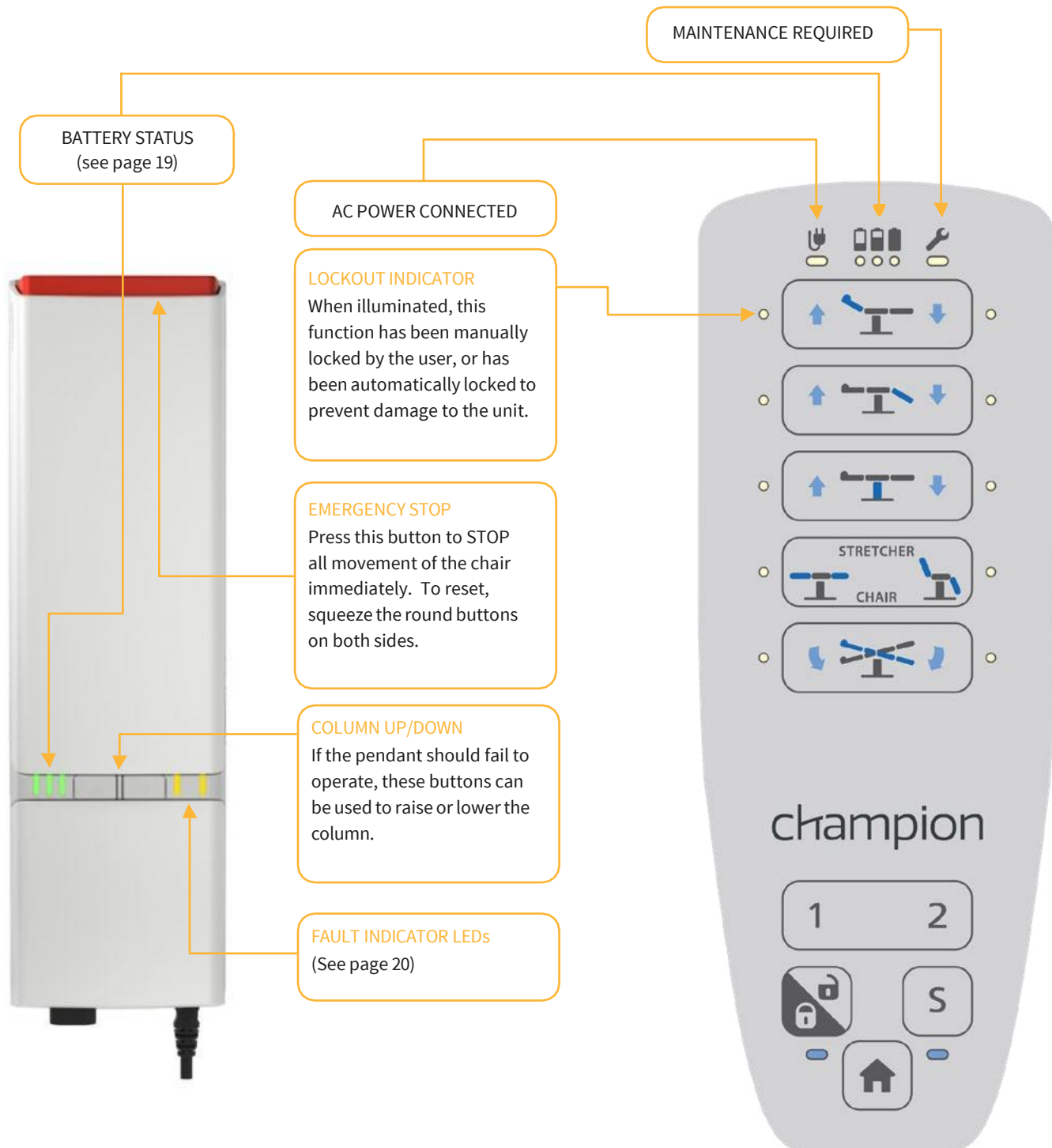

Set the chair to desired position, press "S", then hold HOME for 5 seconds. Default is low chair position.

# PENDANT (CONTROLLER)







## INDICATOR LIGHTS



# CONTROL BOX INDICATOR LIGHTS

LED1 - LED2 - LED3	LED state (Not listed = off)	States in normal use
	LED 1-3 constantly on	75-100% SOC
	LED 1+2 constantly on	50-75% SOC
	LED 1 constantly on	<50% SOC
	LED 1 left side, switches from green to orange and flashes slowly	Buzzer activates when 200 mAh is left in the battery. The customer needs to test own application to check if this is sufficient to fulfil the minimum requirement of one lift and lowering (1 cycle). Software can be adjusted if buzzer level needs to be increased.









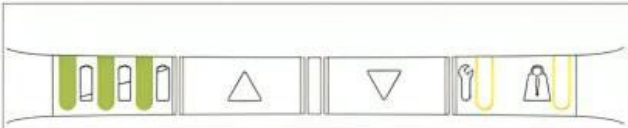

LED1 - LED2 - LED3	LED state (Not listed = off)	States while charging
	LED 1-3 constantly on	90-100%
	LED 1+2 constantly on LED 3 flashes slowly	65-90%
	LED 1 constantly on LED 2 flashes slowly	40-65%
	LED 1 flashes slowly	0-40%
	LED 1+2+3 flash slowly	Charging stopped due to low battery temperature, high battery temperature or other error conditions
	No light in LEDs	Charging stopped due to lost communication to battery

# CONTROL BOX INDICATOR LIGHTS

## FAULT INDICATOR LEDs



PRIORITY	LED4 + LED5	LED state (Not listed = off)	States in normal use	Comments	Reset
0		LED 4 flashing according to BLE pairing state*	Pairing BLE	Not ready to drive	Wait until ready
1		LED 4+5 constantly on	Emergency stop activated	Not ready to drive	Reactivate emergency stop
2		LED 4+5 flashing fast (synchronous)	FATAL ERROR Cannot drive, has to be reset	No movement possible	Reset fatal error routine
3		LED 4+5 flashing slowly (asynchronous toggling)	Not learned/ configured correctly	Not ready to drive	Learn device, configure correct
4		LED 5 flashing slowly	OVERLOAD on CH1	Momentary not ready to LIFT	Reduce load
5		LED 4 flashing slowly	Duty cycle guard	Momentary not ready to LIFT	Wait until ready
6		LED 5 constantly on	Position not to be trusted	Drive is possible	Drive into EOS
7		LED 4 constantly on	Service needed	Drive is possible	SDT, App, HB

# PATIENT INGRESS/EGRESS



## WARNING

PATIENT SHOULD NEVER BE PERMITTED TO ENTER / EXIT FROM ENDS OF PROCEDURE CHAIR WHEN IN AN UPRIGHT, PARTIALLY, OR TOTALLY RECLINED POSITION. EXCESSIVE WEIGHT ON ENDS COULD CAUSE CHAIR TO TILT, RESULTING IN POSSIBLE PATIENT INJURY.

**IMPORTANT:** Follow these instructions for safe and proper patient ingress (entry onto chair) and egress (exit from chair).

- a. Patient ingress and egress should always be made with chair in upright-chair position.
- b. Patient must enter and exit from side of chair with their body weight centered over SEAT section.
- c. See PATIENT TRANSFER section for instruction on transferring patient from one horizontal surface to another.

## PATIENT INGRESS (ENTRY)

1. Depress RED caster brake pedal to lock caster wheels.
2. Adjust chair to lowest height and into upright-chair position.
3. Lower one side rail of seat section.
4. If back section rails are present, remove/lower back section rail of same side.
5. Position patient (facing away from chair) at SEAT section.
6. WITH PATIENT ENTERING FROM SIDE OF CHAIR, assist patient while they sit down on SEAT section.
7. Once patient is fully seated, assist them in rotating their body in-line with chair into a seated position.

## PATIENT EGRESS (EXIT)

1. Depress RED caster brake pedal to lock caster wheels.
2. Adjust chair to lowest height and into upright-chair position.
3. Lower one side rail of seat section.
4. If back section rails are present, remove/lower back section rail of same side.
5. Ensure patient's body weight is centered on SEAT section.
6. WITH PATIENT EXITING TO SIDE OF CHAIR, assist patient in rotating their body by placing their legs over one side of chair.
7. Assist patient into standing position from seated position.

# PATIENT TRANSFER



## WARNING

PATIENT'S BODY WEIGHT SHOULD NEVER BE SHIFTED TOWARDS EITHER END OF CHAIR WHEN IN A PARTIALLY, OR TOTALLY, RECLINED POSITION. SERIOUS PATIENT INJURY MAY OCCUR. ALL PATIENT TRANSFERS MUST BE MADE FROM SIDE OF CHAIR, NOT CHAIR ENDS.

**IMPORTANT:** Follow these instructions for safe and proper patient transfer between chair (in stretcher orientation) and another horizontal surface.

1. Position back, seat, and leg sections into horizontal orientation. (Press Auto Contour button.)
2. Lower/remove all side rails from transfer (right) side of chair.
3. Position chair as close as possible to other surface.
4. Match chair height to height of bed or other horizontal surface.
5. Depress RED caster brake pedal to lock caster wheels.
6. Slide patient from one surface to other, following your facility's standard practices/policies for lateral patient transfers.

# PUSH BAR OPERATION

## LOWERING PUSH BAR

1. Grasp push bar handle while pulling out red release knob.
2. Lower push bar into “down” position.

## RAISING PUSH BAR

Lift push bar handle until it is in “up” position.

**NOTE: The red release knob will engage (lock) automatically.**



## BATTERIES

Your procedure chair comes with one rechargeable Lithium-Ion battery pack. The pack may be charged on the chair, or by using the optional tabletop charger (TMA301-15).

To charge the battery on the chair, plug the AC power cord into the bottom of the control box. The other end of the cord may be plugged into any standard 110-220 VAC outlet.



### PLUG-IN

A fully depleted battery will take approximately 4 hours to charge. As the battery is charging, the charge level indicator lights on the pendant and the control box will illuminate and flash. When the battery is fully charged, all three indicator lights will be continuously illuminated.

## REMOVAL AND INSTALLATION

Remove the battery pack by depressing the two buttons on each side. Install the battery by first inserting the bottom edge, then pushing the top until it clicks.



## EMERGENCY STOP

The large red button on top of the battery can be pressed as an emergency electrical disconnect. When the button is pressed, the battery will remain attached to the control box, but the power supply is disconnected. To reactivate the battery and reset the emergency stop button, press both side buttons once.



## OPTIONS

### “W” OPTION: WIDE WIDTH

For “W” option, patient surface width is 28”. Standard width is 24”.



24” standard



28” “W” option

### “L” OPTION: LOW HEIGHT

The low height option reduces the raised and lowered chair dimensions by 1.5 inches

**NOTE:** To prevent chair damage, ensure ground clearance is at least 1.75” when driving chair up a ramp or over a bump

### “F” OPTION: FOLDING FOOTREST



**WHEN POSITIONING FOOTREST, BE AWARE OF PINCH POINTS**

To stow footrest, place both hands on red handles and lift.

**NOTE:** For patient comfort, stow footrest prior to articulating chair into supine (stretcher) position.



**Extended Footrest**



**Stowed Footrest**

## “Q” OPTION: SCALE

### TO MEASURE PATIENT’S WEIGHT WITH SCALE:

1. Ensure chair base is level.
2. Ensure chair is not contacting nearby objects.
3. Activate chair’s caster brakes.
4. To tare scale, press and hold the “ZERO” button for approximately 3 seconds until “ZERO” appears on the display, release button and the display will read 0.0.
5. Place patient in chair.
6. Tilt the chair rearward a few degrees (optional).
7. After patient is settled, press “WEIGH” button on scale pendant to obtain patient’s weight. After a few moments a stable weight will be indicated by a small black triangle in the display under the  symbol.
8. Return scale pendant to holder.



## CAUTION

- To prevent inaccurate measurement, tare scale before each patient.
- To prevent inaccuracy, prevent extra items (accessories, monitors, IV bags, blankets, pillows, charts, etc.) from being included/excluded during weight checks.
- To ensure the most accurate patient weight is being obtained, weigh the patient when the chair is in the low, seated position.
- Scale display may shut off after sixty seconds, but tare will be maintained. Press “WEIGH” button to wake up scale.
- To toggle between weight units (lb / kg), press “MODE” button on scale pendant. Ensure reading is in the correct unit (lb/kg) when transferring patient’s weight to chart.



## SCALE SPECIFICATIONS:

- Weight capacity: 50 – 500 lbs (23 – 227 kg)
- Accuracy/Repeatability: 0.2 lbs or 0.2% of patient’s weight (whichever is greater)
- Powered by: 9V DC Internal Battery

## WARNING

**WARNING** SCALE SHOULD ONLY BE OPERATED BY TRAINED MEDICAL PERSONNEL AND SHOULD BE CALIBRATED REGULARLY. READINGS ARE FOR REFERENCE ONLY.

THE LOAD CELL UNDER THE SUPPORT COLUMN AND THE PENDANT ARE **NOT** WATERPROOF. THE PENDANT CAN BE CLEANED WITH CLINICAL WIPES BUT NEVER SUBMERGED OR SOAKED IN LIQUID OF ANY KIND. PERMANENT DAMAGE AND/OR FALSE READINGS COULD RESULT.

### CHANGING PENDANT BATTERY

Follow these instructions if pendant does not wake up when “WEIGH” button is pressed.

1. Remove battery cover on back of pendant by sliding it downwards.
2. Take out battery and replace it with a new 9V Industrial battery.
3. Replace battery cover.



### FOOTSWITCH ACCESSORY

The Footswitch accessory is preprogrammed for the left switch to raise/lower the back and the right switch to raise/lower the column.

The Footswitch accessory is configurable. Determine which function is needed for the footswitch to perform. To set the function:

1. Press and hold the following buttons at the same time:
  - a. The **Set/Store** on the handset.
  - b. The **+ Key** on the footswitch to be programmed.

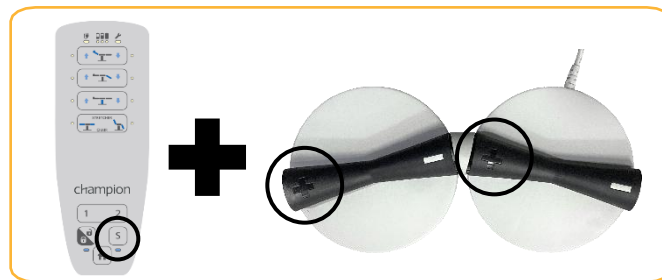

2. Press the **“Up Movement”** or the **“Reverse Tilt”** on handset for the function to be programmed to the footswitch.
3. The pendant will beep to confirm the function has been set.
4. Done.

**Note:** The **“S”** light will stop flashing after 10 seconds

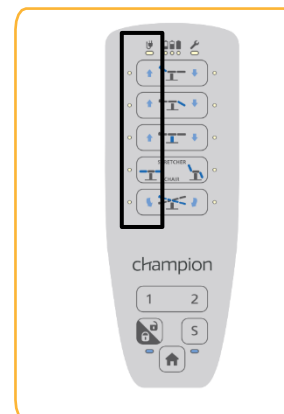

# CLEANING INSTRUCTIONS

COMPONENT	FREQUENCY	PROCEDURE	CLEANING AGENT *	COMMENT
All Rails and Painted Metal	As required/in accordance with facility policies	Wipe with damp cloth and allow to air dry	Facility approved detergents, disinfectants & water	Check for chipped paint/chrome
Base Cover	As required/in accordance with facility policies	Wipe with damp cloth and allow to air dry	Facility approved detergents, disinfectants & water	Check for peeling or missing labels
Actuators and Battery Pack	As required/in accordance with facility policies	Wipe with damp cloth and allow to air dry	Facility approved detergents, disinfectants & water	Clean exterior surfaces only with minimal water
Pendants	As required/in accordance with facility policies	Wipe with damp cloth and allow to air dry	Facility approved detergents, disinfectants & water	Clean exterior surfaces only with minimal water
All Other Surfaces	As required/in accordance with facility policies	Wipe with damp cloth and allow to air dry	Facility approved detergents, disinfectants & water	Check for damage
Check for Damage	As required/in accordance with facility policies	Wipe with damp cloth and allow to air dry	Facility approved detergents, disinfectants & water	Check for damage
3rd Party Accessories	As required/in accordance with facility policies	Consult manual provided by accessory manufacturer.		

# CLEANING INSTRUCTIONS



## CAUTION

**STEAM AND/OR PRESSURE CLEANING CHAIR WILL VOID WARRANTY**

\* Use of Facility approved detergents and disinfectants must comply with the instructions provided by the manufacturer(s) of those products.

## GENERAL CARE & CLEANING

Proper care is essential in ensuring the durability and reliability of Champion upholstery. In general, all products should be:

5. Cleaned
6. Disinfected (per facility policy)
7. Rinsed
8. Allowed to air dry

It is important to note that the terms “disinfecting” and “cleaning” should not be used interchangeably. Disinfectants alone will not provide adequate cleaning since they do not have the appropriate properties to cut grease or oil and remove grime, hair or skin oils. The appearance, feel, and performance of your upholstery may diminish if not cleaned properly.

### CLEANING

Remove grime, hair and body oils. Your furnishings should be cleaned with mild soap & water solution and a damp cloth on a regular basis (especially where skin & hair make contact with upholstery). Avoid harsh detergents or chemicals that could damage the upholstery or finish of your chair. If the furnishing’s upholstery is disinfected with chemicals or bleach mixtures, the chair **MUST** be wiped off using only clean water on a damp cloth and then be allowed to air dry. Failure to rinse upholstery with clean water can result in a build-up of residues that, over time, may lead to drying, cracking or other undesirable changes to appearance, feel and performance.

Please refer to any instruction labels or tags that may have been included with your product for complete care and cleaning instructions. Retain information on the label or tag for future use.

Additional information for cleaning products can be found on our website at: [www.championchair.com/cleaning-instructions/](http://www.championchair.com/cleaning-instructions/)

For customer supplied and non-standard materials, please refer to the individual manufacturer’s cleaning instructions.

# PAD REMOVAL

When removing cushions, pull laterally. Do not pull from top to bottom.



## PREVENTIVE MAINTENANCE

Maintenance is not to be performed by the patient

COMPONENT	FREQUENCY	PROCEDURE	TOOL	COMMENT
Cushion Pads	After each use	Inspect for tears.		If torn, discard cushion.
All Rails	Every three months	<ul style="list-style-type: none"> <li>Inspect for integrity, loose fasteners, and proper operation.</li> </ul>		
All Fastened Joints and Welds	Every three months	<ul style="list-style-type: none"> <li>Inspect all fasteners to ensure proper fit and tightness.</li> <li>Retighten as needed.</li> <li>Inspect all welds for cracks</li> </ul>	<ul style="list-style-type: none"> <li>Wrenches (various sizes)</li> <li>Allen wrenches (various sizes)</li> <li>Screwdriver</li> </ul>	
All Labels	Every three months	<ul style="list-style-type: none"> <li>Inspect for tattered, torn, missing, and illegible labels.</li> </ul>		Call Champion Customer Service for new labels.
Pendants	Every three months	<ul style="list-style-type: none"> <li>Test function of each button</li> <li>Inspect pendant label to ensure it is readable.</li> </ul>		Call Champion Service if pendant is not functioning or label is unreadable.
Quick Release	Every three months	<ul style="list-style-type: none"> <li>With the seatback in full upright position, pull the Quick Release handle under the seat and verify the seatback slowly drops to a flat position.</li> </ul>	N/A	Call Champion Service if the Quick Release mechanism does not work properly.

# BATTERY SAFETY INFORMATION

- Do NOT short-circuit battery terminals, this can cause battery explosion or fire.
- To request Safety Data Sheet (SDS) for battery, contact our Customer Service team.

## BATTERY LIFE

- New batteries are shipped in a deep-sleep state, to prevent self-discharge, so the chair will not operate until the battery is charged. It may take up to 4 hours to fully charge a new battery.
- The Li-Ion battery will “wake up” when connected to the control box, resulting in a higher rate of discharge.
- If your procedure chair will not be used for 6 months or more, remove the battery from the control box to prevent excessive discharge.

**NOTE:** Battery capacity diminishes over time. Charge batteries regularly to maintain healthy battery life. Recommended to replace battery every four years or as required.



## WARNING

Use of Batteries that are NOT factory approved will void any and all warranties. Replace only with Champion part number TMA300-15.

## SUGGESTED PROTOCOL FOR CHARGING YOUR BATTERY:

### Benchtop charger (CHL50):

1. Ensure the cord for your battery charger is fully inserted into the battery charger inlet.
2. Install battery downward onto the charger making sure the battery is properly seated onto the charging cradle.
3. Verify at least one of the three LED's on the charger is flashing.
4. Charge your battery for four (4) hours or until all three LED's on the charger illuminate.

### On-Board Charging:

1. Verify the battery is fully installed onto the control box.
2. Plug the charging cord into the bottom of the control box and the other end into a standard wall outlet.
3. Verify at least one of the three LED's on the charger is flashing. Status can also be monitored by LED's on the pendant.
4. Charging is complete when all three LED's are illuminated.



**IMPORTANT:** ALWAYS REFER TO THE WEIGHT CAPACITY LABEL ON YOUR CHAIR.

In all cases the labeling on the chair at the time of delivery indicates the correct rating for your chair – Weight rating should not be exceeded! **IMPORTANT:** Weight should be evenly distributed.

Do not leave the AC mains cord attached to the control box when a battery is not installed. Exposed contacts on the control box may present a mild shock hazard under certain conditions.

# APPLIED PARTS STATEMENT

The following parts have been determined to be “APPLIED PARTS” per IEC 60601-1 Clause 4.6 ME EQUIPMENT or ME SYSTEM (parts that contact the PATIENT)

- Pads (mattress)
- Arm rest and arm rest pads

The Pads and Arm Rest are necessary for the device to perform its function (patient positioning). These are the only APPLIED PARTS of the device. The Footrest and Pendant may be considered APPLIED PARTS in certain circumstances.

The auto-extending footrest serves only as a convenience feature to make patients more comfortable. It cannot contribute to any hazard when the patient is in the seated position, and it auto extends when the chair is converted to a stretcher position, essentially becoming part of the bed. To address the slight risk of the chair tipping under the patient’s weight, clear markings are applied to both the auto-extending footrest and the folding footrest surface (NO STEP). Please ensure the patient enters and exits from the side of the chair with their body weight centered over the SEAT section.

Although the pendant is NOT INTENDED FOR PATIENT USE, the patient may gain access to the pendant, or come into contact with it, without proper precautions. Please place the pendant on the chair back when not in use.

Visit our website (ChampionChair.com) to view our full line of medical furnishings and Procedure-Chairs, as well as available accessories for your T4 Procedure Chair.

Additional copies of this manual and other product documents are available for download via the resources section of our website.

## SPECIFICATIONS SUBJECT TO CHANGE

**While we endeavor to maintain consistent products, due to conditions beyond our control, specifications are subject to change without notice. We reserve the right to add or delete products at any time and without prior notice. Always provide your product’s specific serial number when ordering any replacement parts. When in doubt, contact a Champion representative (352-854-2929 or 1-800-237-3377) for further information.**

## End of Service Life Statement:

All Champion mobile Procedure Chairs in the T-Series line, when maintained as described in the Operator Manual, are designed and manufactured to remain safe and effective for their intended use for a period of no more than **8 years**.

Although the chair may continue to operate beyond this 8-year period, it may be difficult to support the product due to changes in technology and part availability.



Information contained in this document is based on the latest product data available at the time of printing. Photography, artwork, text and specifications are subject to change. Photographs may show optional items. Champion Manufacturing Inc. reserves the right to make changes to products, materials, options, and/or specification at any time without notice or obligation. Always provide your product’s specific serial number when ordering replacement parts. Contact Champion direct for additional information and the latest specifications.

© 2023 Champion Manufacturing Inc.