



**Frontier™ Centrifuge
FC5306
Instruction Manual**



TABLE OF CONTENTS

1	INTRODUCTION	1
1.1	Safety measures	1
2	INSTALLATION.....	3
2.1	Package contents.....	3
2.2	Replacement or Installation of Rotor.....	4
2.3	Power On	5
2.4	Preparation for Centrifugation.....	5
2.5	Centrifugation (Running).....	5
3	SPECIAL ATTENTION.....	6
3.1	Power supply.....	6
3.2	Use and maintenance	6
4	SPECIFICATIONS.....	7
5	COMPLIANCE.....	8

1 INTRODUCTION

Thank you for choosing this OHAUS product.

Please read the manual completely before using the Frontier™ FC5306 to avoid incorrect operation.

You will find much helpful functionality in Frontier™ 5000 series centrifuge. A few of the many existing features for Frontier™ FC5306 are:

- Small and exquisite body, one-key operation
- Convenient and quick installation and replacement of rotor without need of using tool
- Rotor will immediately stop running if lid is opened during operation
- Desktop power adapter is applicable to 100-240V AC power supply
- Elaborate product with low noise and long service time

1.1 Safety measures



CAUTION: Read all safety warnings before installing, making connections, or servicing this equipment. Failure to comply with these warnings could result in personal injury and/or property damage. Retain all instructions for future reference.

Measures for your protection



- Never work in an environment subject to explosion hazards! The housing of the instrument is not gas tight. (explosion hazard due to spark formation, corrosion caused by the ingress of gases)



- When using chemicals and solvents, comply with the instructions of the producer and the general lab safety rules.

Measures for operational safety

- Do not lean on the centrifuge.
- Do not stay within the clearance envelope longer than necessary for operational reasons.
- Do not deposit any potentially hazardous materials within the clearance envelope.
- Do not unscrew the two halves of the housing.
- Dry off any liquid spills immediately! The instrument is not watertight.

- Verify that the AC adapter's input voltage range and plug type are compatible with the local AC power to be used.
- Do not position the equipment such that it is difficult to disconnect the AC adapter from the power receptacle.
- Make sure that the power cord does not pose a potential obstacle or tripping hazard.
- The equipment is for indoor use only. Use the equipment only in dry locations.
- Use only approved accessories and peripherals.
- Operate the equipment only under ambient conditions specified in these instructions.
- Disconnect the equipment from the power supply when cleaning.
- Do not operate the equipment in hazardous or unstable environments.
- Service should only be performed by authorized personnel.

Exclude the following environmental influences:







- Powerful vibrations
- Direct sunlight
- Atmospheric humidity greater than 80%
- Corrosive gases present
- Temperatures below 5 °C and above 40 °C
- Powerful electric or magnetic fields

2 INSTALLATION

Carefully unpack the box.

2.1 Package contents

The model Frontier™ FC5306 has the following items:

Frontier™ FC5306	Photo	Units
Frontier™ FC5306 main machine		1 set
Angle rotor (8 x 1.5/2ml)		1 set
4 x 0.2ml rectangle rotor for PCR 8-tube bank		1 set
Dedicated DC24V power adapter		1 set
Eight 0.5 ml adapters and eight 0.2 ml adapters		8 x 2 units
Manual		1 set

2.2 Replacement or Installation of Rotor

1. When the machine is delivered from the factory, the seizing shaft sleeve and angle rotor are firmly fixed on the shaft of the drive motor.
2. If it is necessary to dismantle an installed rotor, the user should hold the outside edge of the rotor, and push the protruding clamp towards its center with two thumbs, then lift the rotor upwards.
3. To reinstall rotor, align the oval hole of rotor over the clamp, then gently press down the rotor until the clamp clicks into place.

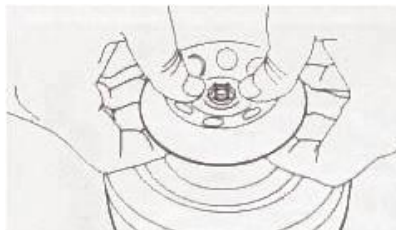
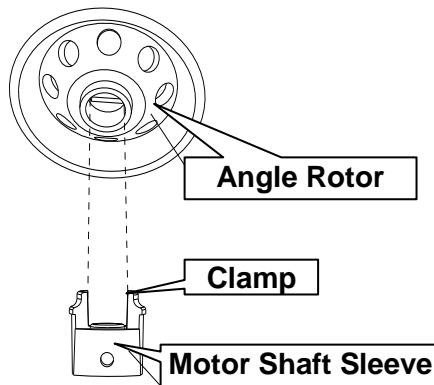

2.3 Power On

1. With the power switch on the back of this machine OFF.
2. Connect the output end of the adapter to the power socket on the back of the machine, and then plug the unit to a power source.

2.4 Preparation for Centrifugation

1. Open the transparent lid (see photo below) and properly add load in a balanced manner (refer to section “3.2 use and maintenance”).
2. Close the lid then press the power switch on the back of this machine to ON (note: The rotor will not run as long as the lid is open).

2.5 Centrifugation (Running)

1. After the lid is closed and the machine switched on, the rotor will automatically start running with its speed increasing to the rated speed, and then it will run stably.
2. Open the lid when the requirement of centrifugation is met, the rotor will immediately slow down to a complete stop.
3. It is unnecessary to turn off power if another centrifugation is required.
4. Turn off and unplug the machine when all centrifugation work is completed or when not in use.



3 SPECIAL ATTENTION

3.1 Power supply

1. The power supply to this machine must be realized through the adapter provided together with the machine. The AC plug of adapter should not be connected with three-phase power source.
2. Don't insert or disconnect the power plug of the adapter with wet hand. Don't forcibly pull the cable to disconnect the power plug.

3.2 Use and maintenance

1. Prepare the micro burette of standard specification with hinged cover for centrifugation. It is only allowed to add sample till approx. 70% of nominal capacity at most. Visually check balance during adding of sample. Don't detach any poisonous or infectious biological sample. Don't detach flammable or explosive chemical sample.
2. The centrifugal tubes with sample must be symmetrically placed into the centrifugal tube holes of the rotor to keep the rotor balanced.
3. When the rotor is installed or replaced, excessive sidewise force should be avoided to prevent its deformation and bending. If the seizing shaft sleeve around the motor shaft is a bit loose, it is necessary to fasten the M3 set screw again.
4. Do not use broken or deformed rotor.
5. During daily cleaning and maintenance, the machine should be wiped with clean water or neutral detergent, and be dried through natural ventilation.
6. During use, attention should be paid to symmetrical and horizontal placement of centrifugal tubes.



WARNING: Disconnect the AC adapter from the AC power supply and the equipment before cleaning. Do not allow liquids to enter the AC adapter or the equipment.

4 SPECIFICATIONS

The technical data is valid under the following ambient conditions:

Operating temperature: 5°C to 40°C

Relative humidity: 20% to 85% relative humidity, non-condensing

Height above sea level: Up to 2000 m

Pollution degree: 2

Installation category: II

Main supply voltage fluctuations: up to $\pm 10\%$ of the nominal voltage

Model	Frontier Mini Centrifuge: FC5306	
Rotor	Angle Rotor	Tube Bank Rotor
Rotating Speed Scope	6000 rpm $\pm 5\%$	
Centrifugal Force	2000 g $\pm 10\%$	
Rotating Direction	Counter clockwise	
Max Capacity	8 x 1.5 ml / 2 ml	4 x 0.2 ml-PCR 8-tube bank
		or 32 x 0.2 ml single centrifugal tube
Adapter	0.2 ml / 0.5 ml	-
Accelerating Time	≤ 2 s	
Decelerating Time	≤ 3 s	
Drive Mode and Motor	Direct drive, with low noise attributable to rolling bearing	
Power Supply	Input: 100-240V ~ 50/60Hz 1.5A Output: 24V \Rightarrow F.6I A	
Dimensions (W x D x H)	5.9 x 6.6 x 5.0 in. / 150 x 168 x 128 mm	
Net Weight	2.316 lb / 1.05 Kg (including free-load angle rotor)	
Shipping Dimensions (W x D x H)	8.5 x 12.0 x 7.6 in. / 216 x 305 x 194 mm	
Shipping Weight	4.079 lb / 1.85 Kg	

5 COMPLIANCE

Compliance to the following standards is indicated by the corresponding mark on the product.

Marking	Standard
	<p>This product conforms to the EMC directive 2004/108/EC and the Low Voltage Directive 2006/95/EC. The complete Declaration of Conformity is available online at http://europe.ohaus.com/europe/en/home/support/compliance/c-e-declaration-of-conformity.aspx</p>

	<p>Disposal</p> <p>In conformance with the European Directive 2002/96/EC on Waste Electrical and Electronic Equipment (WEEE) this device may not be disposed of in domestic waste. This also applies to countries outside the EU, per their specific requirements.</p> <p>Please dispose of this product in accordance with local regulations at the collecting point specified for electrical and electronic equipment.</p> <p>If you have any questions, please contact the responsible authority or the distributor from which you purchased this device.</p> <p>Should this device be passed on to other parties (for private or professional use), the content of this regulation must also be related.</p> <p>For disposal instructions in Europe, refer to http://europe.ohaus.com/europe/en/home/support/weee.aspx.</p> <p>Thank you for your contribution to environmental protection.</p>
-----------------------------------------------------------------------------------	-----------------------------------------------------------------------------------------------------------------------------------------------------------------------------------------------------------------------------------------------------------------------------------------------------------------------------------------------------------------------------------------------------------------------------------------------------------------------------------------------------------------------------------------------------------------------------------------------------------------------------------------------------------------------------------------------------------------------------------------------------------------------------------------------------------------------------------------------------------------------------------------------------------------------------------------------------------------------------------

FCC Note

This equipment has been tested and found to comply with the limits for a Class B digital device, pursuant to part 15 of the FCC Rules. These limits are designed to provide reasonable protection against harmful interference in a residential installation. This equipment generates, uses, and can radiate radio frequency energy and, if not installed and used in accordance with the instructions, may cause harmful interference to radio communications. However, there is no guarantee that interference will not occur in a particular installation. If this equipment does cause harmful interference to radio or television reception, which can be determined by turning the equipment off and on, the user is encouraged to try to correct the interference by one or more of the following measures:

- Reorient or relocate the receiving antenna.
- Increase the separation between the equipment and receiver.
- Connect the equipment into an outlet on a circuit different from that to which the receiver is connected.
- Consult the dealer or an experienced radio/TV technician for help.

Industry Canada Note

This Class B digital apparatus complies with Canadian ICES-001.