

# 560-10-1

---

*Digital Chair Scale  
Software Version 11525*

# Technical Manual



© Rice Lake Weighing Systems. All rights reserved.

Rice Lake Weighing Systems® is a registered trademark of  
Rice Lake Weighing Systems.

All other brand or product names within this publication are trademarks or  
registered trademarks of their respective companies.

All information contained within this publication is, to the best of our knowledge, complete and  
accurate at the time of publication. Rice Lake Weighing Systems reserves the right to make  
changes to the technology, features, specifications and design of the equipment without notice.

# Revision History

---

This section tracks and describes the current and previous manual revisions for awareness of major updates and when the updates took place.

Revision	Date	Description
A	August 17, 2022	Initial manual release; formatted content to match other medical manuals; software version 11525
B	November 20, 2024	Revised battery replacement instructions

*Table i. Revision Letter History*

# Contents

---

<b>1.0</b>	<b>Introduction</b>	<b>7</b>
1.1	FCC Compliance	7
1.2	Disposal	7
1.3	Safety	8
<b>2.0</b>	<b>Assembly</b>	<b>9</b>
2.1	Unpacking	9
2.1.1	Repackaging	10
2.2	Setting Up Scale	11
2.2.1	Footrest Assembly	11
2.2.2	Attach Indicator Display to Chair	12
2.2.3	Attach Seat to Scale Base	13
2.2.4	Arm Rests	13
2.2.5	Load Cell Connection	14
2.2.6	Insert Batteries	15
2.2.7	Power Connection	15
2.3	Casters	16
<b>3.0</b>	<b>Scale Operation</b>	<b>17</b>
3.1	Key Descriptions	17
3.2	Weighing	18
3.3	Hold/Release Function	18
3.4	Preset Tare	18
3.5	Toggle Tare	18
3.6	Using the Body Mass Index (BMI) Function	19
3.6.1	LB Mode	19
3.6.2	KG Mode	19
3.7	Troubleshooting	20
<b>4.0</b>	<b>Configuration</b>	<b>21</b>
4.1	Setup Switch	21
4.2	General Navigation	21
4.2.1	Change Parameters	21
4.2.2	Enter Numbers	21
4.2.3	Save and Return to Main Menu	21
4.3	Configuration Mode	22
4.4	Programming Mode Menu	23
4.5	Default Menu	26
4.6	Scale Calibration	26
4.7	Test Menu	27
<b>5.0</b>	<b>Communication</b>	<b>28</b>
5.1	Push-button Keypad Print	28
5.2	Communication Protocols	29
5.2.1	Escape Protocol	29
5.2.2	Maintenance Protocol	30
5.3	USB Connection	31

**6.0 Maintenance . . . . . 32**  
6.1 Basic Maintenance . . . . . 32  
6.2 Cleaning . . . . . 32

**7.0 Specifications . . . . . 33**



## 1.0 Introduction

The 560-10-1 digital chair scale is efficiently designed to provide accurate, reliable and repeatable weight measurements and has features that enable a fast and convenient weighing process. The 560-10-1 digital chair scale features a robust design, two armrests that can be lifted separately and two foot rests that can be folded up for easy patient access. The scale has four swivel caster wheels including two rear locking wheels.



Manuals are available from Rice Lake Weighing Systems at [www.ricelake.com/manuals](http://www.ricelake.com/manuals)

Warranty information is available at [www.ricelake.com/warranties](http://www.ricelake.com/warranties)

### 1.1 FCC Compliance

#### United States

This equipment has been tested and found to comply with the limits for a Class A digital device, pursuant to Part 15 of the FCC Rules. These limits are designed to provide reasonable protection against harmful interference when the equipment is operated in a commercial environment. This equipment generates, uses, and can radiate radio frequency energy and, if not installed and used in accordance with the instruction manual, may cause harmful interference to radio communications. Operation of this equipment in a residential area is likely to cause harmful interference in which case the user will be required to correct the interference at his own expense.

#### Canada

This digital apparatus does not exceed the Class A limits for radio noise emissions from digital apparatus set out in the Radio Interference Regulations of the Canadian Department of Communications.

Le présent appareil numérique n'émet pas de bruits radioélectriques dépassant les limites applicables aux appareils numériques de la Class A prescrites dans le Règlement sur le brouillage radioélectrique édicté par le ministère des Communications du Canada.

### 1.2 Disposal



#### Product Disposal

The product must be brought to appropriate separate waste collection centers at the end of its life cycle.

Proper separate collection to recycle the product helps prevent possible negative effects on the environment and to health, and promotes the recycling of the materials. Users who dispose of the product illegally shall face administrative sanctions as provided by law.

#### Battery Disposal

Dispose of batteries at appropriate waste collection centers at the end of their life cycle in accordance with local laws and regulations. Batteries and rechargeable batteries may contain harmful substances that should not be disposed of in household waste. Batteries may contain harmful substances including but not limited to: cadmium (Cd), lithium (Li), mercury (Hg) or lead (Pb). Users who dispose of batteries illegally shall face administrative sanctions as provided by law.



**WARNING:** Risk of fire and explosion. Do not burn, crush, disassemble or short-circuit lithium batteries.

## 1.3 Safety

### Safety Definitions:



**DANGER:** Indicates an imminently hazardous situation that, if not avoided, will result in death or serious injury. Includes hazards that are exposed when guards are removed.



**WARNING:** Indicates a potentially hazardous situation that, if not avoided, could result in serious injury or death. Includes hazards that are exposed when guards are removed.



**CAUTION:** Indicates a potentially hazardous situation that, if not avoided, could result in minor or moderate injury.



**IMPORTANT:** Indicates information about procedures that, if not observed, could result in damage to equipment or corruption to and loss of data.

### General Safety



Do not operate or work on this equipment unless this manual has been read and all instructions are understood. Failure to follow the instructions or heed the warnings could result in injury or death. Contact any Rice Lake Weighing Systems dealer for replacement manuals.



#### WARNING

Failure to heed could result in serious injury or death.

Ensure every individual who operates or works with this unit has read and understands all safety information.

Do not transport the scale while someone is on the scale.

Do not allow minors (children) or inexperienced persons to operate this scale.

Do not use in the presence of flammable materials.

Do not use this product if any of the components are loose or cracked.

Do not use near water.

Do not use the scale on slippery surfaces, such as a wet floor.

Do not use this scale when a person's body or feet are wet, such as after taking a bath.

Do not place fingers into slots or possible pinch points.

To avoid cross contamination, the scale should be cleaned regularly.

Prior to cleaning, make sure the scale is disconnected from the power source.

People with disabilities, or who are physically frail, should always be assisted by another person when using this scale.



#### IMPORTANT

Do not drop the scale or subject it to violent shocks.

Do not jump on the scale.

For accurate weighing, the scale must be placed on a flat, stable surface.

Operating at voltages and frequencies other than specified could damage the equipment.

Avoid contact with excessive moisture.

Do not make alterations or modifications to the scale.

Rice Lake Weighing Systems offers optional AC adapters; utilizing an adapter not supplied by Rice Lake Weighing Systems voids all warranties and approvals.

Weight exceeding the maximum capacity may damage the scale.

## 2.0 Assembly

### 2.1 Unpacking

Place the unopened box in an open area that has ample room for unpacking the scale. Visually inspect the 560-10-1 digital chair scale to ensure all components are included and undamaged. Parts contained in the shipping box include:







Item Description	Quantity
Chair scale frame 	1
560-10-1 Operation Manual Indicator 	1
Footrests 	2
Handle assembly 	1
<b>Parts Kit Contents</b>	
Zip ties 	6
Batteries 	6

Table 2-1. 560-10-1 Digital Chair Scale Component Parts



Item Description	Quantity
5 x 25 mm screws 	4 Used to attach the molded seat to the chair scale frame
1/4 x 3/8 inch bolts 	4 Used to attach the footrest to the footrest assembly frame (2 are already installed in the footrest)
1/4 x 3/8 inch round head screws - not shown	2 Used for the handle assembly - already in the handle assembly frame
5/32 x 1/4 inch flat head screws 	2 Used to attach the indicator plate to the handle frame

Table 2-1. (Continued) 560-10-1 Digital Chair Scale Component Parts

### 2.1.1 Repackaging

Retain the packaging for use in the event that the scale must be returned or moved. The product must be properly packed with sufficient packing materials. Whenever possible, use the original carton and packing materials when shipping the scale back.



**IMPORTANT:** Damage caused by improper packaging is not covered by the warranty.

## 2.2 Setting Up Scale

Use the following steps to set up the 560-10-1 digital chair scale. If parts were damaged in shipment, notify Rice Lake Weighing Systems and the shipper immediately.

1. Move the carton to an area where the scale can be assembled. It's recommended that the scale be placed on a hard, level surface for the most accurate weighments.

The chair comes in three main pieces:

- Main frame
- Leg and footrest assembly
- Handle assembly

2. Locate the operation manual from inside the box and set aside as it will provide instructions on the proper setup.
3. Remove the main frame from the packaging.

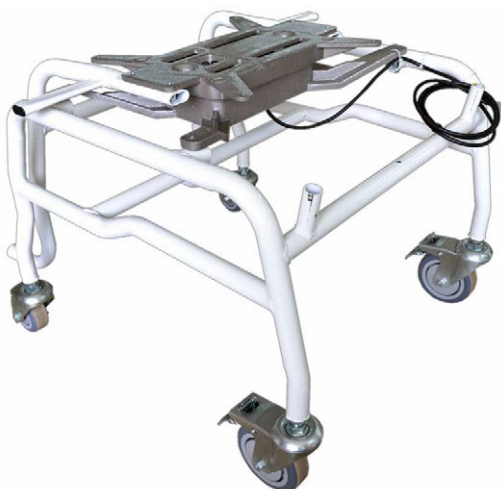

Figure 2-1. Chair Scale Main Frame

### 2.2.1 Footrest Assembly

Use the following steps to attach the two footrests to the scale base.

1. Slide the foot pads onto the footrest frame.

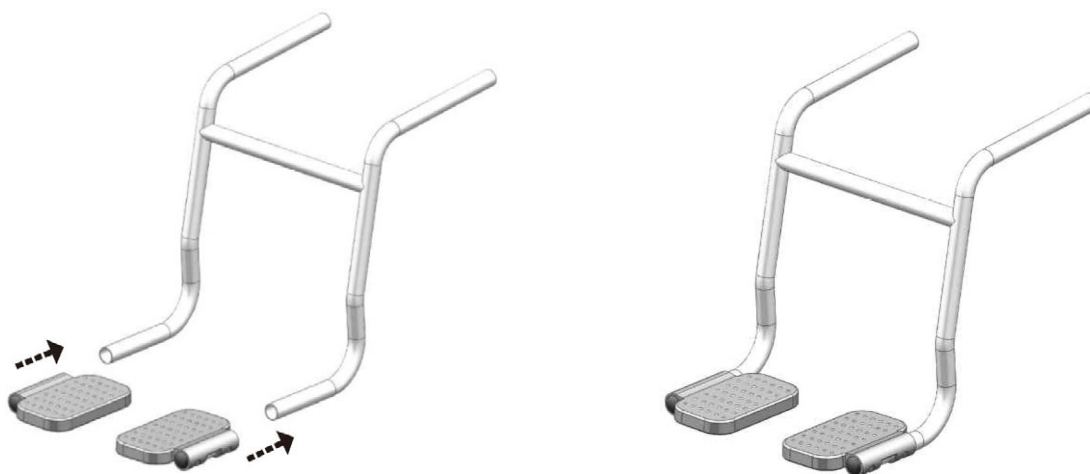

Figure 2-2. Slide and Secure Foot Pads onto Footrest Frame

2. Use the four (4) 1/4 x 3/8 inch bolts provided in the parts kit bag to bolt the footrests onto the frame.

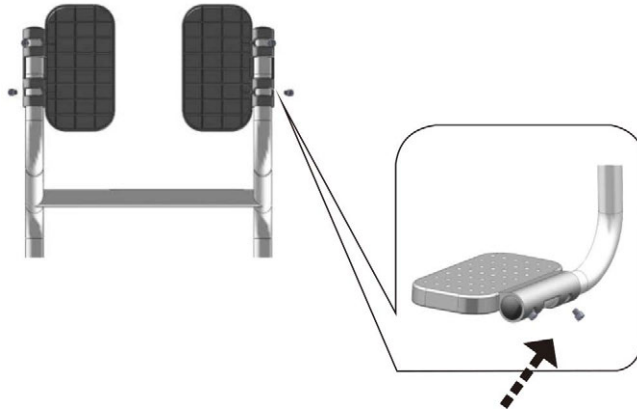

Figure 2-3. Secure with Screws

### 2.2.2 Attach Indicator Display to Chair

Use the following steps to attach the display to the handle assembly.

1. Attach the indicator to the support bracket using two (2) 1/4 x 3/8 inch round head screws (provided).



Figure 2-4. Attach Indicator to Handle Assembly

2. Loosen the two 1/4 x 3/8 inch round head screws that are located in the main chair frame



Figure 2-5. Insert Handle Assembly to Chair Frame

3. Insert handle assembly onto the chair scale frame.

4. Tighten the handle to the frame.

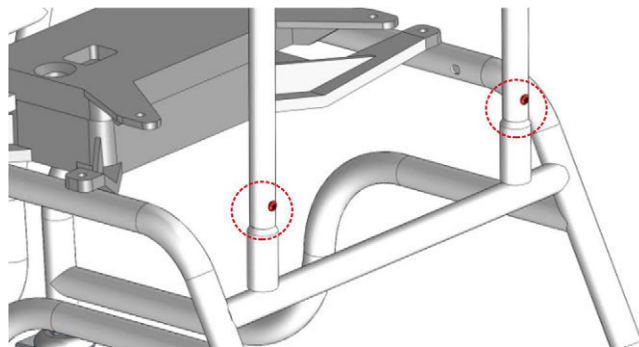

Figure 2-6. Secure with Screws

### 2.2.3 Attach Seat to Scale Base

Use the following steps to attach the seat to the chair scale frame.

1. Fit the seat to the frame and attach using the four (4) 5 x 25 mm screws provided at the points indicated below.

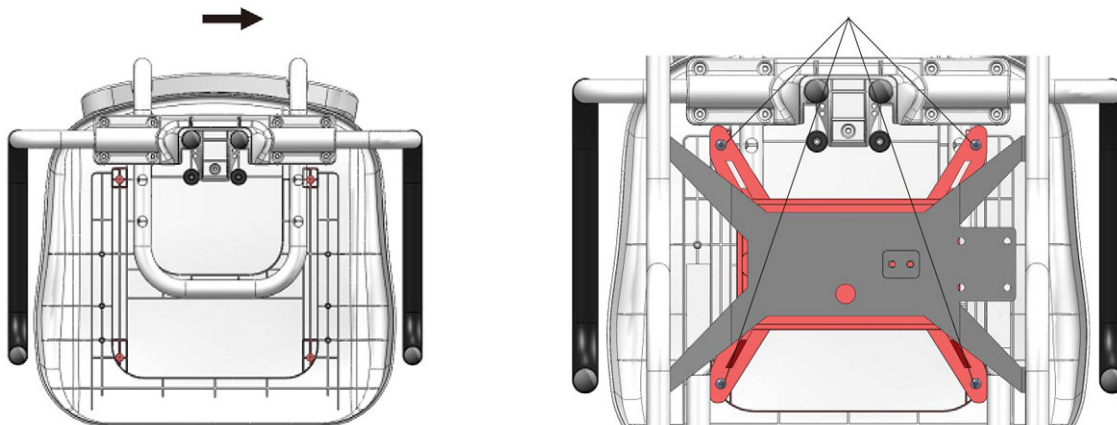

Figure 2-7. Attach Seat to Frame

### 2.2.4 Arm Rests

The 560-10-1 digital chair scale has two arm rests that can be lifted separately for easy patient access. The arm rests are permanently mounted to the chair scale seat.

### 2.2.5 Load Cell Connection

The scale comes with the load cell cable coiled and ready to plug into the back of the indicator.

1. Uncoil the load cell cable and route along the chair scale frame. Secure with six (6) zip ties (included).

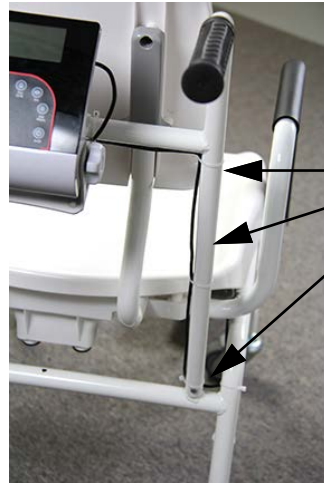

Use zip ties to secure load cell cable to chair frame

Figure 2-8. Use Zip Ties to Secure Load Cell Cable

2. The indicator comes with the back cover plate removed. Plug the load cell connector into the indicator as shown below.



Figure 2-9. Ensure Load Cell Cable Does Not Get Pinched Prior to Putting Back Cover On

3. Attach the molded back cover onto the indicator ensuring that the load cable does not get pinched.



Figure 2-10. Attach Molded Back Cover onto Indicator

## 2.2.6 Insert Batteries

The six AA batteries supplied with the scale provide an average of 25 hours of continuous use.

To install the batteries:

1. Turn thumbscrew counterclockwise then remove battery cover.
2. Insert batteries into the battery chamber as illustrated.

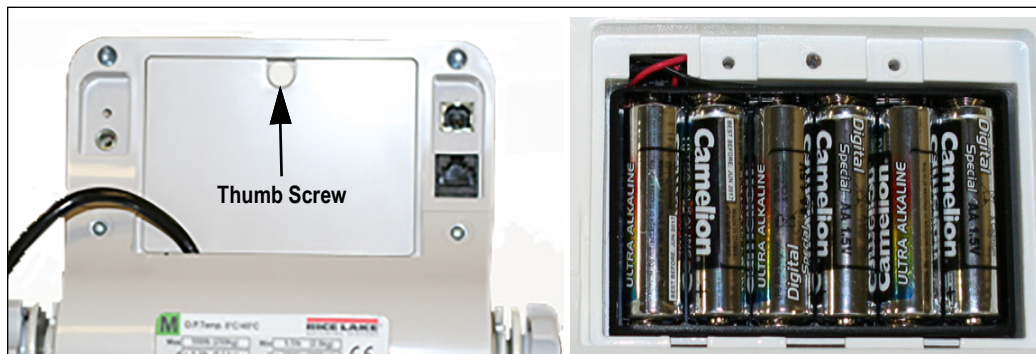

Figure 2-11. Battery Chamber

3. Put the cover in place and turn the thumbscrew clockwise to secure.



**NOTE:** Remove the batteries prior to storing if the product is not going to be used for an extended period of time.



**NOTE:** If the LO BAT indicator activates, for accurate weighing, replace the batteries or connect the scale to an AC power source as soon as possible.

## 2.2.7 Power Connection

An optional AC power adapter can be used when a power outlet is available.



**IMPORTANT:** Only use power adapters supplied by or purchased from Rice Lake Weighing Systems. The use of a power adapter not from Rice Lake Weighing Systems voids the warranty.

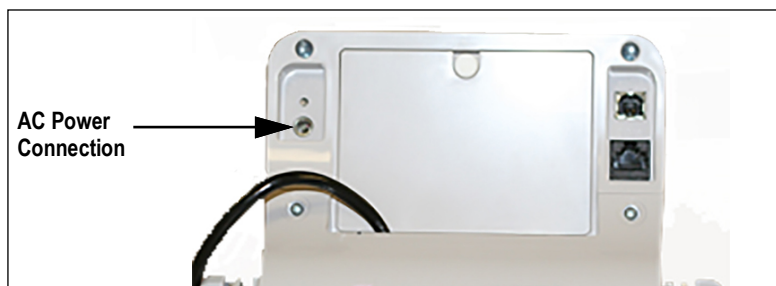

Figure 2-12. Power Connection Site



**NOTE:** The battery annunciator on the display turns off when using an AC power connection. The brightness of the backlight is reduced to 60% when using battery power.

## 2.3 Casters

The 560-10-1 digital chair scale comes equipped with four casters. Ensure casters are in a locked position prior to having a patient sit down on the chair scale.



*Figure 2-13. Caster Wheels (one of four shown)*

## 3.0 Scale Operation

This section describes the front panel and includes procedures for operation of the scale.



Figure 3-1. Front Panel Keypad

### 3.1 Key Descriptions

The display has 10 front panel keys. Key functions are described in the table below.

**IMPORTANT:** The front panel keys are very sensitive, so only a gentle press is required.













Key	Name	Function
 On/Off	On/Off	Powers the scale on or off
 Print LB/KG	Print LB/KG	Sends data out from the RS-232 port; Allows to toggle between kilograms and pounds providing that it is enabled in <b>Configuration</b> mode; Cannot toggle while in the <b>BMI</b> mode
 Zero	Zero	Only functions if the current weight is stable and less than 2% of the capacity of the scale. Anything over 2% requires a recalibration
 Hold Release	Hold Release	Displays most current weight value on the display and holds that value when the patient is off the scale. A second press releases the weight value. Not active while in <b>BMI</b> mode
 BMI	BMI	Pressing the <b>BMI</b> key enables access to the BMI (Body Mass Index) mode (defaults when scale is turned on). The patient is gets on the scale, weight stabilizes and press the <b>BMI</b> key. The display then asks for the patient height to calculate out the patient BMI.
 TARE	TARE	Used to remove the weight initially of anything on the scale that shouldn't be included in the total weight of the patient on the scale
 CLEAR	CLEAR	When using the BMI function, the display looks for a height entry. Pressing <b>Clear</b> changes this entry back to 190.0 cm (default) or 5 ft, 7.5 in. Once BMI is displayed, pressing the <b>Clear</b> key exits BMI
 ENTER	ENTER	Used to accept height in <b>BMI</b> mode; accepts the value of the parameter last entered and moves to the next stage. Pressing and holding Enter during startup will display ID. This is the first setup on entering into configuration mode
 Up Arrows	Up Arrows	Adjusts the value of the flashing digit/number Adjusts height input (0.5 in/0.5 cm) while in <b>BMI</b> mode
 Down Arrows	Down Arrows	Adjusts the value of the flashing digit/number Adjusts height input (0.5 in/0.5 cm) while in <b>BMI</b> mode

Table 3-1. Key Functions



## 3.2 Weighing

Use the following steps to weigh.

1. Press  to turn on the scale. **0.0** appears on the display along with the **ZERO** annunciator.
2. Place the patient on the scale. The patient's weight is displayed, the **LOCK** annunciator is on and the indicator beeps to indicate the end of the weighing process.
3. Press  to change the display from lb to kg and vice-versa.
4. Press and hold  until **OFF** displays to turn off the scale.

## 3.3 Hold/Release Function

Use the following steps to use the Hold/Release function.

1. Press  to turn on the scale. **0.0** prompts along with **ZERO** on the display.
2. Press  once the patient's weight stabilizes. The patient's weight and the **HOLD** and **LOCK** annunciators remain on the display when the patient is off the scale.
3. Press  again to return the scale to zero.





**NOTE:** Pressing  will not work while using Hold/Release function.



**NOTE:** Pressing  prior to the patient getting on the scale will also hold the weight display.

## 3.4 Preset Tare

Use the following steps for the Preset Tare function prior to patient weighing if additional items are being used by the patient.

1. Press  to turn on the scale. **0.0** appears on the display along with the **ZERO** annunciator.
2. Place additional item(s) on the scale.
3. Press  until the display returns to **0.0** and **NET** annunciator appears on the display.
4. Remove additional item(s) from the scale. The weight displays with a negative symbol to the left of it.



**NOTE:** Not removing the additional item(s) prior to patient weighing will also work.





5. Position the patient and additional item(s) on the scale. The display identifies the patient weight. The **NET** annunciator is still active. The weight of the additional item(s) remains stored in memory for the duration of this weigh in.
6. To cancel the tare weight, remove patient from the scale and press  until **NET** disappears from the display and the display turns back to **0.0** and **GROSS** appears.



**NOTE:** Tare weight is also canceled when the scale is turned off.

## 3.5 Toggle Tare





Use the following steps to use the Toggle Tare function when the additional item to be weighed is known.

1. Press  when the scale is empty and **0.0** displays. The default values prompts while **0.0** is flashing on the display (default is programmed to be 33.0 lb/15.0 kg).
2. Use  and  to adjust the value. Press  to start the tare function. The **NET** annunciator turns on instead of the **GROSS** annunciator.





## 3.6 Using the Body Mass Index (BMI) Function

Use the following steps in determining the BMI.

### 3.6.1 LB Mode

1. Ensure that the scale is at zero.
2. Place the patient on the scale to obtain a weight. The **LOCK** annunciator appears on the display.
3. Press . The **BMI** and **FT/IN** annunciators appear on the display and a default height value of 5 feet - 7.5 inch (5 - 07.5) is flashing.
4. Use  and  to adjust the height value.
5. Press .
6. The BMI value and **BMI** annunciator are shown on the display. Press  to return to the **Weighing** mode and the BMI function will be turned off.

### 3.6.2 KG Mode

1. Ensure that the scale is at zero.
2. Place the patient on the scale to obtain a weight. The **LOCK** annunciator appears on the display.
3. Press . The **BMI** and **CM** annunciators appear on the display and a default height value of 170.0 cm (170.0) is flashing.
4. Use  and  to adjust the height value.
5. Press .
6. The BMI value and **BMI** annunciator are shown on the display. Press  to return to the **Weighing** mode and the BMI function will be turned off.

## 3.7 Troubleshooting

Refer to the following table to check and correct any failure before contacting service personnel.

Symptom	Possible Cause	Corrective Action
Scale does not turn on	Dead batteries	Replace batteries or connect to AC power
	Faulty electrical outlet	Use a different electrical outlet
	Bad power supply	Replace adapter
Questionable weight or the scale does not zero	External object is interfering with the scale	Remove the interfering object from the scale
	Display did not show 0.0 before weighing	Help the patient off the scale, zero the scale and begin the weighing process again
	Scale is not placed on a level floor	Ensure scale is level and begin the weighing process again
	Scale is out of calibration	Check the weight with a certified calibration weight
	Scale base is touching floor during a weighment	Adjust height of feet so fingers can slide between the base of scale and the floor all the way around the platform
The display shows a <b>STOP</b> message	The load on the scale exceeds the capacity of the scale	Remove the excess weight and use the scale according to manufacture specifications
The display shows <b>LO Bat</b> message	The battery is low	Replace batteries
The display shows E and Err messages as detailed below		
E06	Identifier - ADC	AD too high
E07		AD too low
E10	Overload	Scale has been overloaded. Remove load from scale
E4L	BAT	Battery low, but still usable- one bar left on indicator display
E4U		Battery low and unstable - no bars left on indicator display
E11	CAL	Calibration Error - recalibrate scale
Err 1	Load cell cable may be plugged into wrong connection port	Ensure cable is connected to the load cell connection port. <b>Note:</b> Load cell connection point is located underneath the curved plastic cover of the indicator. Remove four back retaining screws, remove curved back cover to access load cell connection point.
Err 2	Low saturation state (low A/D)	The load cell is not connected properly; Check the cables and mechanical connections; if the problem persists, replace the set of load cells
Err 3	High saturation state (high A/D)	See Err 2
Err 6	Unstable weight; Cannot calibrate	Check the load cell mechanical surroundings and ensure nothing is contacting the load cell and that the cables are properly welded
Err 7	Scale isn't moving	Make sure feet are installed on the scale. Turn the feet all the way in and then back them out three full turns, then level the scale
SAT	Damaged load cell cable	Replace load cell cable
	Load cell cable may be plugged into wrong connection port	Ensure cable is connected to the load cell connection port. <b>Note:</b> Load cell connection point is located underneath the curved plastic cover of the indicator. Remove four back retaining screws, remove curved back cover to access load cell connection point.

Table 3-2. Troubleshooting Table

## 4.0 Configuration

Options and parameter setup are done through the scale configuration.

### 4.1 Setup Switch

Access to the setup switch is located under the tilt stand cover. Use a Phillips head screwdriver to remove the four screws holding the cover in place (shown below — left photo).

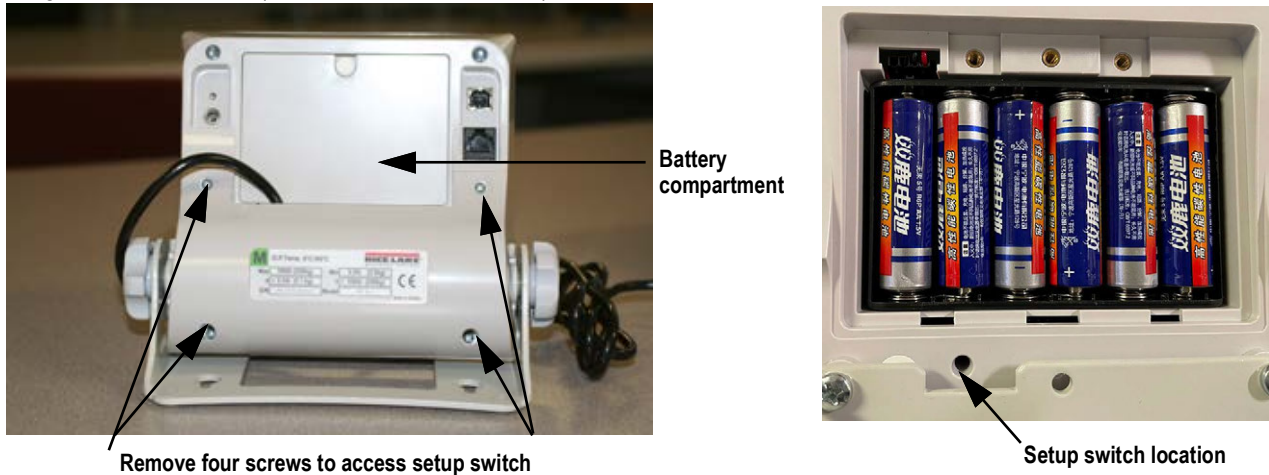

Figure 4-1. Setup Switch Location

### 4.2 General Navigation

Use the buttons on the front panel to navigate through the menus and parameters.

#### 4.2.1 Change Parameters

- Press **BMI** to scroll through the menus and/or parameters
- Press **ENTER** to enter a displayed menu and/or parameter
- Press **▲** or **▼** to scroll through values
- Press **ENTER** to save the displayed selection and move to the next parameter

#### 4.2.2 Enter Numbers



- Press **ENTER** to enter parameter value
- Press **▲** or **▼** to increment/decrement numbers
- Press **BMI** to move to the next digit
- Press **ENTER** to save value and move to the next parameter

#### 4.2.3 Save and Return to Main Menu

- When a parameters selection/value is correct, press **ENTER**. The next parameter displays
- When all parameters selections/values are correct, **SAVE** displays
- Press **ENTER**. **DONE** displays.
- Press **ENTER** to save settings and return to weigh mode.

### 4.3 Configuration Mode

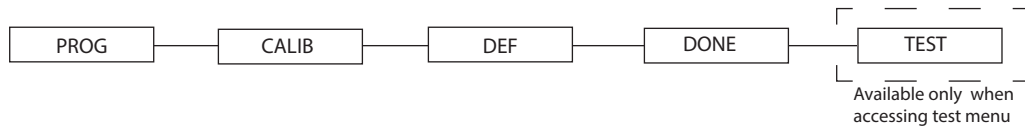

Use the following steps to enter into **Configuration** mode.

1. Ensure the scale is turned off.
2. Turn the scale on by simultaneously pressing  and . Continue to hold both keys until **ld** appears. The unit cycles through its startup function and continues to display the software version.
3. Access the setup switch located in the back of the scale to enter the setup parameters for the scale. Use a small paper clip, small screwdriver or other similar object to press the setup switch.
4. Once the setup switch is pressed, **PROG** displays.
5. Scale can be configured using a series of menus accessed through the front panel when the scale is in **Setup** mode.



See [Section 4.7 on page 27](#)

Figure 4-2. Top Level Menu

6. Press  to advance to the desired menu.
7. Press  and advance in the manual to the related menu selection for further instructions.

## 4.4 Programming Mode Menu

Various parameters can be set while in **Programming** mode.

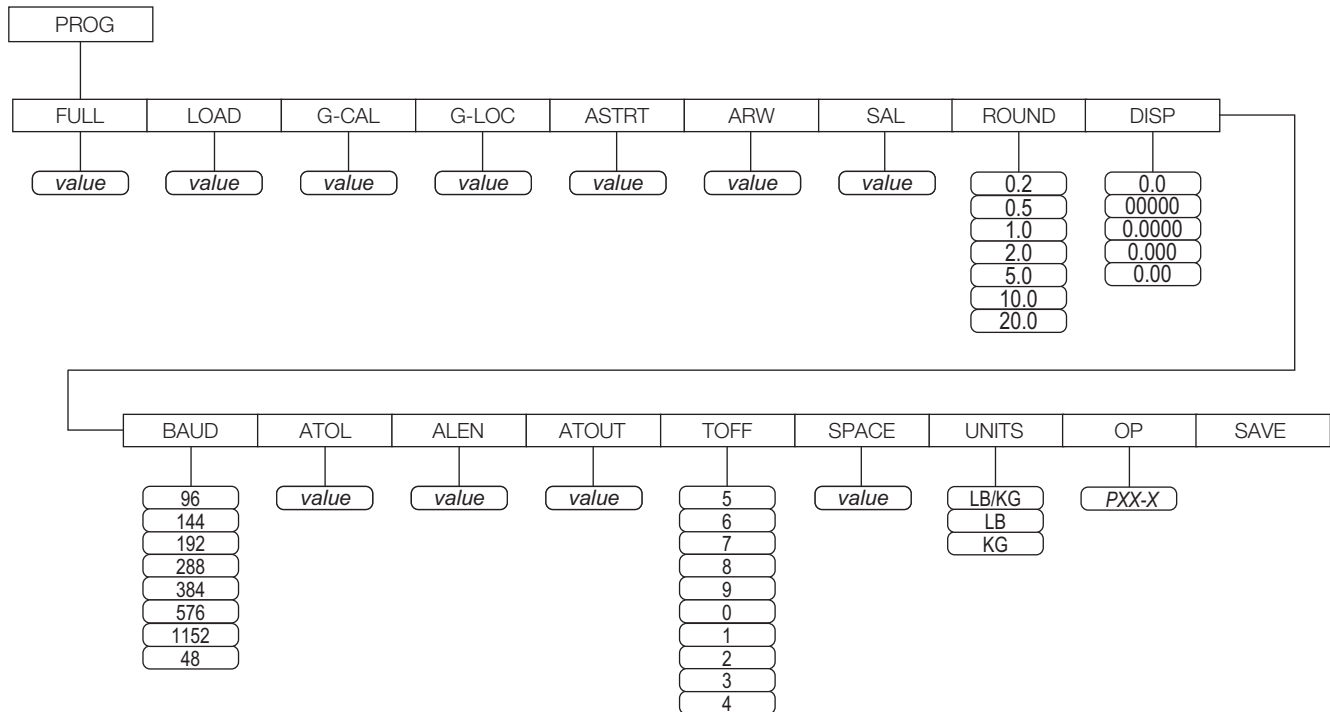

Figure 4-3. Programming Mode Menu Structure

The following table lists the various display messages and sequence when setting up the scale.

Parameter	Description	Choices	Steps
FULL	Full capacity of the scale	Value ( <i>capacity of scale</i> )	The display toggles between a numeric value and <b>FULL</b> ; If you do not want to change the value, press the <b>BMI</b> key to move to the next setting; Example: from FULL to LOAD. If you want to change the value, use the following steps; 1. Press <b>ENTER</b> key to change value starting with the right most digit. 2. Use the Up/Down arrow keys to increment/decrement numbers. 3. Press <b>BMI</b> key to move to the left. 4. Use the Up/Down arrow keys to increment/decrement numbers. 5. Press <b>BMI</b> key again to move to the left 6. Use the Up/Down arrow keys to increment/decrement numbers. 7. When done press <b>ENTER</b> key to move to the next parameter (LOAD).
LOAD	This is the amount of weight applied during calibration; Can also be changed in the calibration menu	Value (200 lb)	The display toggles between a numeric value and <b>LOAD</b> ; If you do not want to change this value, press the <b>BMI</b> key to move to the next setting; Example: from LOAD to ASTART; If you want to change the value, use the following steps; 1. Press <b>ENTER</b> key to change value starting with the right most digit. 2. Use the Up/Down arrow keys to increment/decrement numbers. 3. Press <b>BMI</b> key to move to the left. 4. Use the Up/Down arrow keys to increment/decrement numbers. 5. When done, press <b>ENTER</b> key to move to next parameter (ASTART).

Table 4-1. Configuration Mode Menu

Parameter	Description	Choices	Steps
ASTART	Weight process start limit — Maximum (full capacity)/10; Determine when the weight algorithm starts (when the “----” is displayed), below this value the scale will show live weight	Value (2.0)	The display toggles between a numeric value and <b>ASTART</b> ; If you do not want to change this value, press the <b>BMI</b> key to move to the next setting; Example: from ASTART to ARW; If you want to change the value, use the following steps; 1. Press <b>ENTER</b> key to change value starting with the right most digit. 2. Use the Up/Down arrow keys to increment/decrement numbers. 3. Press <b>BMI</b> key to move to the left. 4. Use the Up/Down arrow keys to increment/decrement numbers. 5. When done, press <b>ENTER</b> key to move to the next parameter (ARW).
ARW	Auto Reweigh — Restarts the weight algorithm if the weight changed by more than this value.	Value (4.0 lb)	The display toggles between a numeric value and <b>ARW</b> ; If you do not want to change this value, press the <b>BMI</b> key to move to the next setting; Example: from ARW to SAL; If you want to change the value, use the following steps; 1. Press <b>ENTER</b> key to change value starting with the right most digit. 2. Use the Up/Down arrow keys to increment/decrement numbers. 3. Press <b>BMI</b> key to move to the left. 4. Use the Up/Down arrow keys to increment/decrement numbers. 5. When done, press <b>ENTER</b> key to move to the next parameter (SAL).
SAL	Semi Auto Live — This value is the interval between weight displays during the algorithm process	Value (0.5)	The display toggles between a numeric value and <b>SAL</b> ; If you do not want to change this value, press the <b>BMI</b> key to move to the next setting; Example: from SAL to ROUND; If you want to change the value, use the following steps; 1. Press <b>ENTER</b> key to change value starting with the right most digit. 2. Use the Up/Down arrow keys to increment/decrement numbers. 3. When done, press <b>ENTER</b> key to move to the next parameter (ROUND).
ROUND	Scale Resolution — Values in kg: 1, 2, 5, 10, 20, 50, 100 Values in lb: 1, 2, 5, 10, 20, 50, 100, 200	0.2 0.5 1.0 2.0 5.0 10.0 20.0 0.1	The display toggles between a numeric value and <b>ROUND</b> ; The decimal point location is set to the DISP parameter display decimal point location; If you do not want to change this value, press the <b>BMI</b> key to move to the next setting; Example: from ROUND to DISP; If you want to change the value, use the following steps; 1. Press <b>ENTER</b> key to change value. 2. Press the Up/Down arrow keys to change the available parameters. 3. When done, press <b>ENTER</b> key to move to the next parameter (DISP).
DISP		0.0 0 0.0000 0.000 0.00	The display toggles between a numeric value and <b>DISP</b> ; If you do not want to change this value, press the <b>BMI</b> key to move to the next setting; Example: from DISP to BAUD; If you want to change the value, use the following steps; 1. Press <b>ENTER</b> key to change value. 2. Use the Up/Down arrow keys to change the available parameters. 3. When done, press <b>ENTER</b> key to move to the next parameter (BAUD).
BAUD	Baud rate	96 48 1152 576 384 288 192 144	Indicator display illustrates first two digits of baud rate only; The display toggles between a numeric value and baud; If you do not want to change this value, press the <b>BMI</b> key to move to the next setting; Example: from BAUD to ATOL; If you want to change the value, use the following steps 1. Press <b>ENTER</b> key to change value. 2. Use the Up/Down arrow keys to change the available parameters. 3. When done, press <b>ENTER</b> key to move to the next parameter (ATOL).
ATOL	Algorithm initial tolerance — Maximum value is 255. Values above 255 will not let you proceed and will return to the previous value.	Value (10)	The display toggles between a numeric value and <b>ATOL</b> ; If you do not want to change this value, press the <b>BMI</b> key to move to the next setting; Example: from ATOL to ALEN; If you want to change the value, use the following steps; 1. Press <b>ENTER</b> key to change value starting with the right most digit. 2. Use the Up/Down arrow keys to increment/decrement numbers. 3. Press the <b>BMI</b> key to move to the left. 4. When done, press <b>ENTER</b> key to move to the next parameter (ALEN).

Table 4-1. Configuration Mode Menu (Continued)

Parameter	Description	Choices	Steps
ALEN	Algorithm initial exponent — Maximum value 10. Values above 10, will not let you proceed and will return to the previous value.	Value (8)	The display toggles between a numeric value and <b>ALEN</b> ; If you do not want to change this value, press the <b>BMI</b> key to move to the next setting; Example: from ALEN to ATOUT; If you want to change the value, use the following steps; 1. Press <b>ENTER</b> key to change value starting with the right most digit. 2. Use the Up/Down arrow keys to increment/decrement numbers. 3. When done, press <b>ENTER</b> key to move to the next parameter (ATOUT).
ATOUT	Algorithm maximal exponent — Maximum value is 15. Values above 15, will not let you proceed and will return to the previous value.	Value (10)	The display toggles between a numeric value and <b>ATOUT</b> ; If you do not want to change this value, press the <b>BMI</b> key to move to the next setting; Example: from ATOUT to TOFF; If you want to change the value, use the following steps; 1. Press <b>ENTER</b> key to change value starting with the right most digit. 2. Use the Up/Down arrow keys to increment/decrement numbers. 3. Press <b>BMI</b> key to move to the left. 4. Use the Up/Down arrow keys to increment/decrement numbers. 5. When done, press <b>ENTER</b> key to move to the next parameter (TOFF).
TOFF	Auto off timer — Measured in minutes; 0 = always on; Maximum is 9 minutes; When using an external power supply, this parameter is irrelevant	5 4 3 2 1 0 9 8 7 6	The display toggles between a numeric value and <b>TOFF</b> ; If you do not want to change this value, press the <b>BMI</b> key to move to the next setting; Example: from TOFF to UNITS; Press the <b>ENTER</b> key to move to the next parameter; (UNITS); If you want to change the value, use the following steps; 1. Press the <b>ENTER</b> key to change values. 2. Use the Up/Down arrow keys to change the available parameters. 3. When done, press <b>ENTER</b> key to move to the next parameter (UNITS).
UNITS	Units — Selects the unit of measure; It can be either Kg/Lb, Kg only or Lb only	KG/LB KG LB	The display toggles between unit of measurements and <b>UNIT</b> ; If you do not want to change this value, press the <b>BMI</b> key to move to the next setting; Example: from UNITS to OP; If you want to change the value, use the following steps; 1. Press the <b>ENTER</b> key to change values. 2. Press the Up/Down arrow keys to change the value. 3. When done, press the <b>ENTER</b> key to move to the next parameter (OP).
OP	Binary options: OP0 — Live weighing options (0=disable, 1=enable) OP1 — Communication protocol (0=ESC, 1=maintenance) OP2 — BMI menu (0=disable, 1=enable) OP3 — RTC power (0=disable, 1=enable) OP4 - Semi-Auto-Live — (0=disable, 1=enable) OP5 - Full calculation — (0=spatial, 1=multiply by (0=disable, 1=enable) OP6 - Tare - (0=disable, 1=enable) OP7 - Bat type — (0=dry batteries, 1=rechargeable batteries) OP8 — OIML mode - (0=disable, 1=enable	OP0 OP1 OP2 OP3	The display toggles between a binary option and <b>POO-0</b> ; If you do not want to change this value, press the <b>BMI</b> key to move to the next settings If you want to change the value, use the following step 1. Press <b>ENTER</b> to change parameters. 2. Use the Up/Down arrow keys to select the display value you want to change. 3. Press <b>BMI</b> key to move the flashing cursor a. Use the Up/Down arrows to change the value. b. Press the <b>BMI</b> key to move the flashing cursor. 4. Press <b>ENTER</b> key to save all of the display parameters. <b>SAVE</b> appears on the display. 5. Press <b>ENTER</b> key again and <b>DONE</b> appears indicating that you are now done entering all of the parameters of the scale.
Press the <b>BMI</b> key to cycle back to the top level menu choices, ie: PROG/CALIB/DEF/DONE			

Table 4-1. Configuration Mode Menu (Continued)

## 4.5 Default Menu

The default menu is used to return the scale back to its factory settings and is shown below.

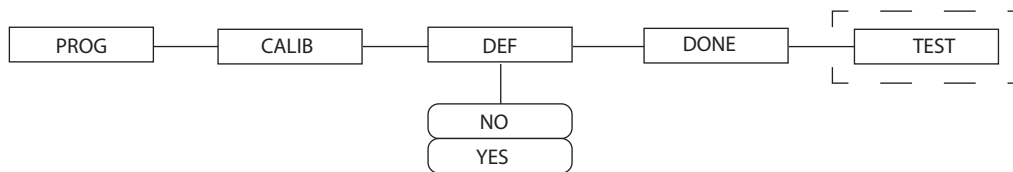

Figure 4-4. Default Menu

Use the following steps to return the settings back to their factory default.

1. Press . The display shows a default value of **NO**.
2. To change to **YES**, use and to adjust the value.
3. Press and the display shows **DONE**.
4. Press to return to top level level menu.







**NOTE:** Selecting **YES** and pressing will reset to factory defaults settings without changing the calibration and will return you to Weigh mode.

## 4.6 Scale Calibration







Use the following steps to calibrate the scale.

1. Press and simultaneously to power on the scale.
2. The unit cycles through its startup function and continues to display the software version. Continue to hold both keys until **ld** appears.
3. Access the setup switch located in the back of the scale to enter the setup parameters for the scale. Use a small paper clip, small screwdriver or other similar object to press the setup switch on the back of the indicator (under the cover).
4. **Prog** displays. Press to toggle along the parameter menu.
5. **Calib** displays and enter the calibration parameters.
6. Press and a numeric value is displayed which represents the amount of weight that is used for calibration.  
Lb will be flashing. To switch between lb and kg, press or . Once a unit is selected, press and the right most digit will be flashing.
7. To change the calibration load value, press or to increment/decrement the flashing digit.
8. Use to move the flashing digit to the left or right.
9. Once all the digits have been entered, press and **Clear** displays.
10. Make sure the scale platform is clear of weight and press again then **=====** displays.
11. A request to put the chosen load on the platform is displayed by **Put xxx.xx**.
12. Put the chosen weight on the platform and press . **=====** displays then **Save** displays.

13. Press  again and the display indicates **Done**.
14. Press  three times to exit back out to the top level **Done** parameter.
15. Press  to return to **Weigh** mode.
16. To exit calibration without changing zero or span existing calibration, press , then press .

## 4.7 Test Menu

To access the **TEST** menu, use the following steps.

1. Press  and  simultaneously to power on the scale until **ID** flashes.
2. Press  again.
3. Continue to press  to scroll through the various menu items.
4. Once complete, press  again then **Done** displays.
5. Press  to start the weighing process.

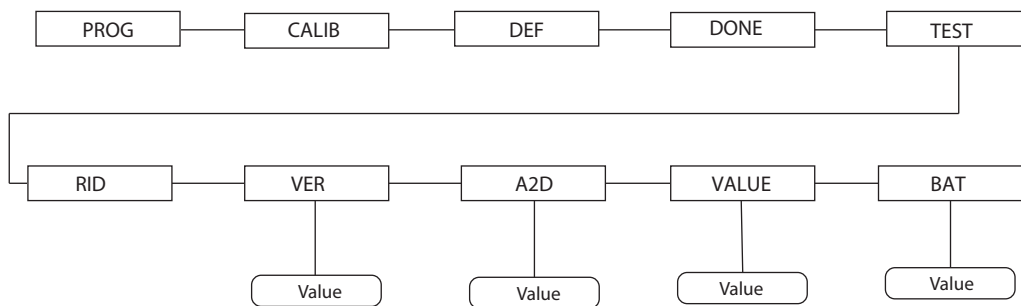

Figure 4-5. Test Menu

Parameter	Choice	Description
RID	Value	Displays internal ID number
VER	Value	Displays the current software version
BAT	Value	Displays the current battery level
VALUE	Value	Displays the actual value
A2D	Value	Displays the actual raw counts of the scale

Table 4-2. Test Menu

## 5.0 Communication

The unit comes with an RS-232 port that enables weight data to be transmitted to other equipment, such as a computer or printer. The RS-232 cable with DB-9 connector (PN 100719) is available from Rice Lake Weighing Systems. That connection is shown in USB Connection section.

The RS-232 parameters are:

- 9600 baud (selectable in the programming mode)
- 8 data bits
- 1 stop bit
- no parity
- no handshaking

There are three methods of communication:

- Push-button keypad print
- Standard remote protocol
- Escape protocol

### 5.1 Push-button Keypad Print

With a stable, in-range weight, press and hold  for at least three seconds, or until the scale emits two quick beeps.



**NOTE:** If the scale does not beep after five seconds, release  as the weight was either in motion or out of range.

If displaying weight and not BMI, the scale will send out the following 21 character string:

```
xxxxxxxx<SP>uu<SP>mmmm<SP><CR><LF>
```

Token	Description
xxxxxxxx	Weight with decimal point and “-” sign
<SP>	Space
uu	Unit - lb or kg
mmmm	Mode - gross or net
<CR>	Carriage return
<LF>	Line feed (moves cursor down to the next line)

Table 5-1. Print Format Tokens

Example:

```
60.1 KG= <PATIENT><SP><WEIGHT><SP>-60.1<SP>KG<SP><CR><LF>
```

In BMI mode (displaying the BMI value), the scale will send out the following data:

```
PATIENT WEIGHT    60.1 KG
PATIENT HEIGHT 170.0 CM
PATIENT BMI       20.8
```

Example in KG:

```
<PATIENT><SP><WEIGHT><SP>-60.1<SP>KG<SP><CR><LF>
<PATIENT><SP><HEIGHT><SP>-170.0<SP>CM<SP><CR><LF>
<PATIENT><SP><B><SP><M><SP><I><SP><SP><SP><20.8<SP><SP><SP><CR><LF>
```

Example in LB:

```
<PATIENT><SP><WEIGHT><SP>132.4<SP>LB<SP><CR><LF>
<PATIENT><SP><HEIGHT><SP>5-07.5<SP>FT<SP><CR><LF>
<PATIENT><SP><B><SP><M><SP><I><SP><SP><SP><20.4<SP><SP><SP><CR><LF>
```

In case of under weight or over weight, the word **Under** or **Over** will be sent correspondingly.

## 5.2 Communication Protocols

The scale has two communication protocols, escape and maintenance protocol.

### 5.2.1 Escape Protocol

An escape protocol is where the escape (0X1B or ASCII 27) is used to indicate that there is a command following. On the PC side there must be a listener created by the vendor that will interpret this protocol. This listener must also take care of all the issues regarding data integrity to make sure that the data that was sent and received is valid.

Two examples include:

- Scale initiated communication
- PC initiated communication

The escape protocol commands table shows (below) what can be sent across communications lines.

PC Initiated	ESC Value
Request current values/settings	R
Diagnostics	A
Send scale control messages	C
PC Initiated	ESC Value
Send single reading	R
Send diagnostic response	

Table 5-2. Escape Protocol Commands

ESC characters that will be used is shown below.

Name	ESC Character	ESC Value with Parameters	Description
Reading	R	R	Tells PC the scale is sending a reading; immediately following this is the value that is sent Example: <ESC><R>ESC><W0200.0<ESC>Nm<ESC>E
Weight	W	Wnnn.n	The patient weight ( <i>Example: W02000 means 200.0</i> ). If scale is overloaded or under loaded, 999.99 is returned
Height	H	Hnnn.n	Patient height
BMI	B	Bnn.n	Patient BMI
Units	N	Nc	Indicates the units the values have been taken ( <i>m=metric, c=constitutional</i> ).
End of Packet (EOP)	E	E	Indicates the end of the command has been reached.
Diagnostics (request)	A	Accc	A request for a diagnostic test on certain parts of the scale (like battery life, load cells).
Diagnostics (response)	Z	Zccc	The response of the diagnostics done on the scale; values include error codes to indicate an issue, or all zeros (Z000) to indicate the scale is performing properly
Control (set a value)	C	Cccc=c	Sets the value of the scale's global settings <i>Example: &lt;ESC&gt;&lt;CUOM=m&gt;&lt;ESC&gt;&lt;E sets the unit of measurement</i>

Table 5-3. ESC Characters

Name of Control	Identifier	Unit
Unit of Measure (metric or constitutional)	UOM	c (m or c)

Table 5-4. Scale Global Values and Identifiers

### Samples of Escape Protocol

Examples of what is sent to the computer from the scale.

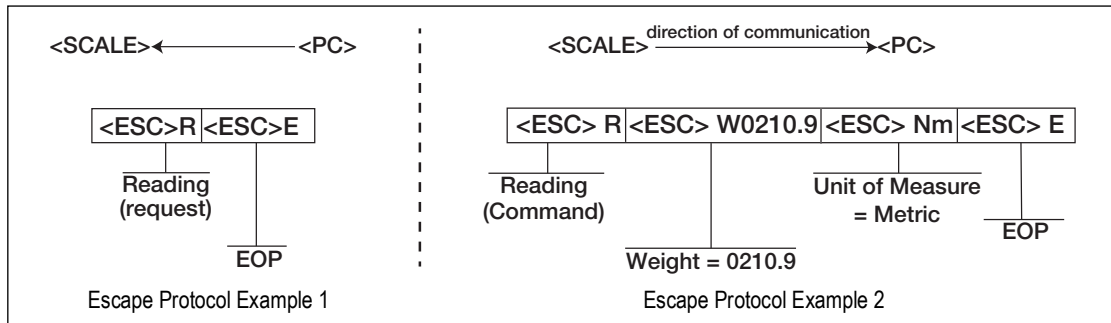

Figure 5-1. Escape Protocol Examples

Examples of diagnosing battery request and responses.

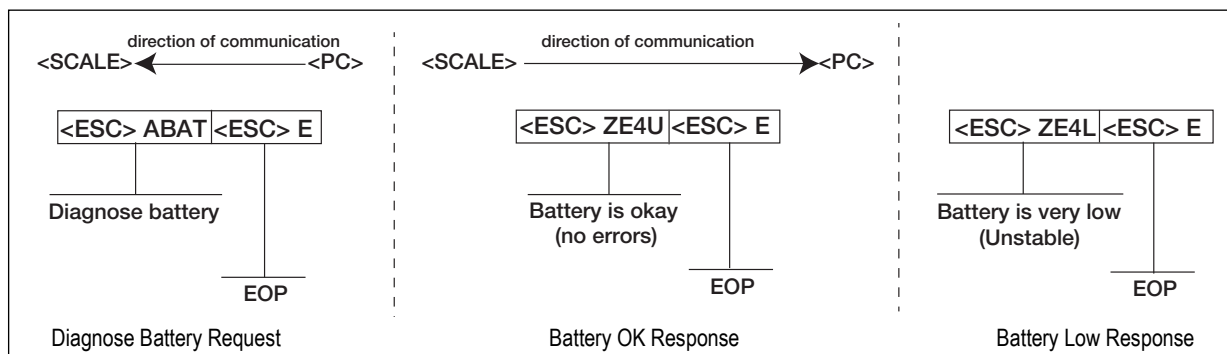

Figure 5-2. Diagnose Battery Examples

### 5.2.2 Maintenance Protocol

Maintenance protocol commands are listed below.

Command	Definition
R	Reboot
V	Firmware ID + development version
W	Current weight
A	Current AD
Z	Zero the scale
F	Show flash values (used for the first flash process)
L	USB On/Off (not available on USB communication)

Table 5-5. Maintenance Protocol Commands

### 5.3 USB Connection

The scale has the capability of connecting to a Windows® computer (PC) using a USB cable (not included) and a terminal emulation program. A terminal emulation program allows the transfer of data between the scale and PC using a serial port.



Figure 5-3. Connection Ports

**NOTE:** Apple® and Macintosh® computers are unable to transfer the necessary data to the scale. Only use a PC for data transfer.

Connecting software and downloads should always be addressed by the IT department for safety reasons and can vary depending on what type of computer platform is being used.

**NOTE:** Consult the IT department if driver protections are preventing the use of the USB driver. Driver protections may need to be temporarily disabled on Windows 10 or later computers to allow for the installation of the USB driver.

1. Connect the scale's indicator to a PC using a USB-Type B to USB-Type A cable (not included).
2. Turn the indicator on.

**NOTE:** In most cases, the PC should find the driver and automatically configure the driver when the scale is plugged into a USB port.

3. Open a terminal emulation program, such as Advanced Serial Port Terminal, pUttY or Hercules (used in this example).
4. Connect to the serial port assigned by the PC (COM5 in example). This can be found in Device Manager. Once selected, press **Open**.

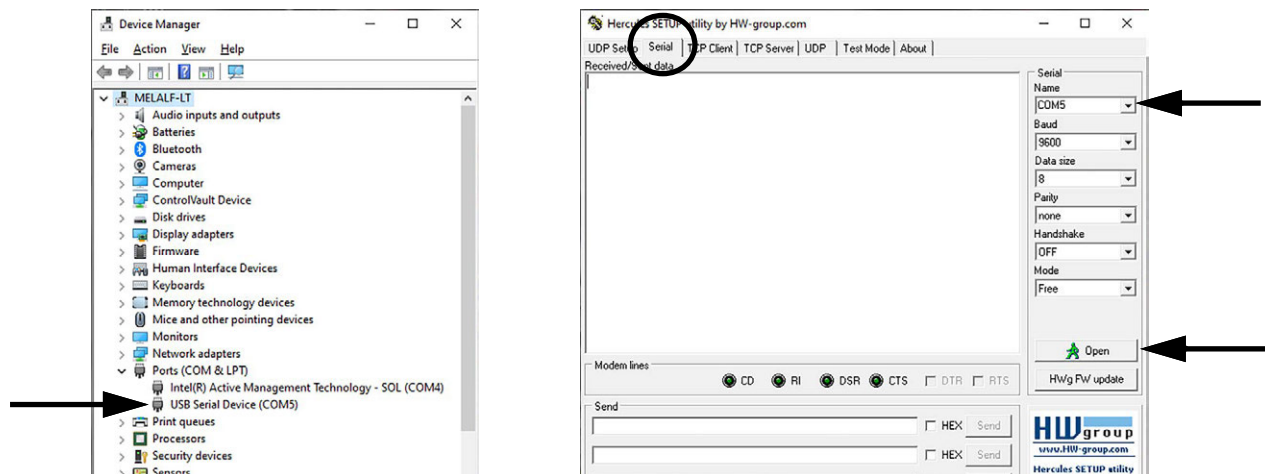

Figure 5-4. Connecting to a Serial Port

5. With weight on the scale, press and hold the **Print** button on the indicator for three seconds. The patient's weight is sent to the PC.

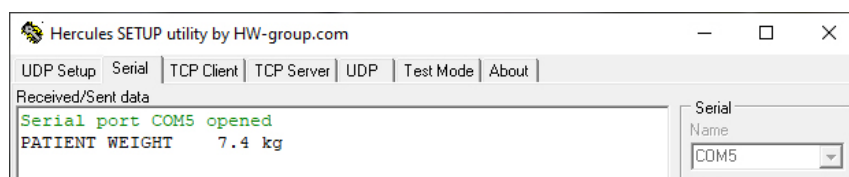

Figure 5-5. Patient Weight Displayed

## 6.0 Maintenance

---

The following section provides instructions for maintaining and cleaning the unit.



**IMPORTANT:** Do not immerse the scale in cleaning or other liquid solutions.

Do not use Isopropyl alcohol or other solutions to clean the indicator display surface.

### 6.1 Basic Maintenance

Before the first use of the scale and after periods of non-use, check the scale for proper operation and function. If the scale does not operate correctly, contact a qualified service personnel.

Go through the following steps for basic maintenance.

- Check the overall appearance of the entire scale for any obvious signs of damage
- Inspect the condition of the AC power adapter cord for cracking, fraying or for broken or bent prongs

### 6.2 Cleaning

Proper care and cleaning is essential to ensure a long life of accurate and effective operation. Before beginning the cleaning process, disconnect the scale from the AC power source.

- Clean all external surfaces with a clean, damp cloth or tissue. Mild soap and water solution may be used. Dry with a clean soft cloth
- Do not immerse the scale into cleaning or other liquid solutions
- Do not use Isopropyl alcohol or other solutions to clean the display surface

## 7.0 Specifications

---

### Power

Optional AC Adapter - 120 VAC-9VDC-60Hz / 230 VAC-9VDC-50Hz

### Battery Type

(6) AA size Alkaline batteries

### Battery Use

25 hours continuous use

Automatic power-off can be configured

### Data Communications

RS-232 with RJ-45 jack

USB Connection

Selectable baud rate, default - 9600

8 bits

No parity

1 stop bit

No handshaking

### Environmental

Operating Temperature      50°F to 95°F (10°C to 35°C)

Storage Temperature        32°F to 122°F (0°C to 50°C)

Humidity                        85% relative humidity

### Capacity

660 lb x 0.2 lb (300 kg x 0.1 kg)

### Seat Dimension

26.2 in W x 33.5 in L x 37 in H (665 mm x 850 mm x 940 mm)