

ARCTIKO

true cooling specialists

OPERATING INSTRUCTIONS

BIOMEDICAL REFRIGERATOR AND FREEZERS

LR 350 / 650 / 1350

PR 650 / 1350

LF 650 / 1350

Contents

Page

Standard and general warnings	4
Table of dimensions	5
Technical data table	5
Testing and intended use	6
Introduction	6
Product description	7
Certification	7
General safety regulations	7
Customers responsibilities	8
Customers service requests	9
Ordering of spare parts	9
Product configuration	9
Materials and refrigerants	9
Warning labels	10
Installation	14
Transportation and handling	14
Positioning	14
Wiring and electrical hoop-up	15
Set up operations	15
Re- installation	16
Stabilizer bracket	16
Scrapping and disposal	18
Remote alarm connection	18
Probe and access port	19
Operation	20
Controller	21
Controller feature split PCB	21
Remote HMI terminal	21
User terminal	22
Navigation and actuator/function direct activation mode	23
Programming mode from the user terminal	25
Alarms and signal	27
Signals	27
Alarms	27
APPLICA APP	29

Contents

Page

Maintenance	34
Routine maintenance	34
Cleaning the interior and exterior of the appliance	34
Condenser cleaning	34
Troubleshooting	35
Service	37
Spare parts	37
After sales	37
Warranty	37

STANDARD AND GENERAL WARNINGS

PRODUCTS APPLICABLE TO THIS MANUAL

The present manual is exclusively valid and applicable to the following products range:

R290 upright refrigerators

Models: PR350, LR650, PR650, LR1350, PR1350

Adjustable temperature control range: lowest T = +1°C (33,8°F), highest T = +12°C (53,6°F)

Operating temperature: +4°C to 6°C (39,2°F to 42,8°F)

Factory pre-set to: +4°C (39,2°F)

R290 upright freezers

Models: LF650, LF1350

Adjustable temperature control range: lowest T = -25 °C (-13°F), highest T = -10 °C (14°F)

Operating temperature: -22 °C to -20 °C (-7,6°F to -4°F)

Factory pre-set to: -20 °C (-4°F)

Environmental Operating Conditions

- Nominal environmental operating condition: **Climatic class 4** (30°C, HR%=55%);
- Ambient temperature operating range: **10°C~40°C;**
- Humidity: **65% maximum, non-condensing;**
- Electrical supply: **110~127V/60Hz;**
- Altitude: **2000 meters MSL** (Mean Sea Level);
- Usage: **This product is intended for use indoors only.**

TABLE OF DIMENSIONS

Models	Capacity	Dimensions (WxDxH)	Packaging dimensions (WxDxH)	Shipping Weight
Refrigerators				
PR350	11,8 cu.ft. 335 lt	23 5/8" x 23 5/8" x 71 21/32" 60 x 60 x 182 cm	26 49/64" x 28" x 79 17/32" 68 x 71x 202 cm	286,6 lbs 130 kg
LR650	21,8 cu.ft. 617 lt	28 11/32" x 31 1/2" x 79 1/8" 72 x 80 x 201 cm	31 1/2" x 35 53/64" x 87" 80 x 91 x 221 cm	330,7 lbs 150 kg
PR650	21,8 cu.ft. 617 lt	28 11/32" x 31 1/2" x 79 1/8" 72 x 80 x 201 cm	31 1/2" x 35 53/64" x 87" 80 x 91 x 221 cm	378 lbs 171 kg
LR1350	47,3 cu.ft. 1340 lt	56 45/64" x 31 1/2" x 79 1/8" 144 x 80 x 201 cm	60 15/64" x 35 53/64" x 87" 153 x 91 x 221 cm	531,3 lbs 241 kg
PR1350	47,3 cu.ft. 1340 lt	56 45/64" x 31 1/2" x 79 1/8" 144 x 80 x 201 cm	60 15/64" x 35 53/64" x 87" 153 x 91 x 221 cm	822,3 lbs 373 kg
Freezers				
LF650	21,8 cu.ft. 617 lt	28 11/32" x 31 1/2" x 79 1/8" 72 x 80 x 201 cm	31 1/2" x 35 53/64" x 87" 80 x 91 x 221 cm	330,7 lbs 150 kg
LF1350	47,3 cu.ft. 1340 lt	56 45/64" x 31 1/2" x 79 1/8" 144 x 80 x 201 cm	60 15/64" x 35 53/64" x 87" 153 x 91 x 221 cm	531,3 lbs 241 kg

TECHNICAL DATA TABLE

Models	T Range	Electrical rate	Absorbed power	Gas	Gas q.ty
Refrigerators					
PR350	+1° / +12°C	115V/1ph/60Hz	260W	R290	0,070 kg
LR650	+1° / +12°C	115V/1ph/60Hz	290W	R290	0,090kg
PR650	+1° / +12°C	115V/1ph/60Hz	290W	R290	0,090kg
LR1350	+1° / +12°C	115V/1ph/60Hz	470W	R290	0,100kg
PR1350	+1° / +12°C	115V/1ph/60Hz	470W	R290	0,100kg
Freezers					
LF650	-25° / -10°C	115V/1ph/60Hz	500W	R290	0,110kg
LF1350	-25° / -10°C	115V/1ph/60Hz	750W	R290	0,120kg

Note: All relevant data referring to these products can be found on the data label visible on the rear part of the cabinet. Here is an example of the label:

TESTING AND INTENDED USE

This equipment is tested in compliance with established regulations and then shipped ready for use.

This equipment is intended for general purpose laboratory cold storage.

“If the equipment is used in a manner not specified by the manufacturer, the protection provided by the equipment may be impaired.”

INTRODUCTION

This manual provides all instructions required for the correct use of the equipment and to keep it in optimal condition. It also contains important user safety information. The following professional roles are explained in order to define individual responsibilities:

Installer: a qualified technician who installs the equipment in accordance with these instructions.

User: the person who, after having read this manual carefully, uses the equipment in accordance with the intended specification of use described in this manual. User's responsibilities: ensure that the product is kept at suitable temperatures in an ambient environment less than +40°C (104°F); be aware of the regulations governing the conservation of products to refrigerate and to observe any whatsoever hygiene indications that may be applicable. The user is obliged to carefully read the manual and refer to its information at all times. Particular attention must be paid to safety warnings (refer to Section 1.5).

Routine maintenance technician: qualified operator able to perform routine maintenance of the equipment by following the instructions in this manual.

Service engineer: qualified technician, authorized by the manufacturer to perform extraordinary maintenance of the equipment.

The symbol  appears at certain points in the manual to draw the reader's attention to important safety information.

The manufacturer declines any responsibility in case of improper use of the equipment deviating from the reasonably construed intended use, and for all operations carried out that are not in compliance with the instructions reported in the manual.

This manual must be stored in an accessible and known place for all operators (installer, user, routine maintenance technician, service engineer).

PRODUCT DESCRIPTION

The equipment comprises a single body with paneling in various materials and insulation with expanded polyurethane foam. The equipment instruments are located on the front panel where the electrical wiring is housed. The motor unit and the evaporator unit are housed on the top of body. The interior parts are fitted with suitable supports for shelves. The doors are fitted with an automatic return device and magnetic seal elements. During the design and construction stage all measures have been adopted to implement total safety including radius interior corners, funnel-shaped base panel to convey condensate to exterior, no rough surfaces, fixed guards protecting moving or potentially dangerous parts.

CERTIFICATION

The appliances listed in this manual are manufactured in accordance with the following regulations:

- **UL/CSA 61010-1 3rd edition and IEC 61010-2-011**
- **Energy Star Certification: High Performance lab grade refrigerators and freezers-**
according following Standards:10CFR Part 431 Subpart C,10 CFR Part 431.64 and 10CFR part 431.66(e)/NRCAN:CAN/CSA C657-15.
- **Packaging certification: ISTA 3E.**

GENERAL SAFETY REGULATIONS

Read this manual carefully and follow the instructions contained herein.

The user assumes full responsibility in case of operations carried out without observing the instructions in the manual.



Do not use this product with flammable gases or flammable solvents.



Do not store flammable gases, flammable liquids or flammable solids in these units.

GENERAL SAFETY REGULATIONS

Primary general safety regulations:

- Do not touch the unit with wet hands and/or feet. Do not use the equipment with bare feet;
- Do not insert screwdrivers or other pointed objects between guards or moving parts of the equipment;
- Do not pull the power cord to disconnect the equipment from the electrical mains. Make sure that the equipment is not used by unsuitably qualified persons;
- Before performing any cleaning or maintenance on the equipment disconnect it from the electrical mains by switching off the main switch and extracting the plug;
- Never use any metallic scouring pads, brushes, abrasive cleaners or strong alkaline solution on any surface.
- The relocation of the unit must be performed by qualified personnel. Do not shift the refrigerator from side to side as this may create leakage point across the cooling unit piping.
- In case of faults or malfunctions, switch off the equipment and do not attempt to repair it by yourself as doing so may void the warranty. All service and repair operations must be performed exclusively by a manufacture's authorized engineer. (Authorized service technician, trained service personnel, authorized service personnel)
- Propane fridge/freezer, like any other appliance, must have access to fresh air/oxygen;



Do not use FLAME to check for gas leak.



Do not under any circumstances try to modify or repair valves, regulator, connectors, controls or any other appliance. Doing so creates the risk of a gas leak.

CUSTOMER'S RESPONSIBILITIES

The customer is required to:

- Execute the electrical connection of the equipment. Prepare the place of installation;
- Provide consumable materials for cleaning. Perform routine maintenance;
- In the case of power failures or malfunctions do not open the doors, in order to maintain the internal temperature for as long as possible. If the problem persists for more than a few hours, move the contents to a more suitable place.

CUSTOMER SERVICE REQUESTS

- For all technical problems and any requests for technical service, refer exclusively to the manufacturer's authorized personnel;

ORDERING OF SPARE PARTS

- Orders of spare parts should be made by consulting the part reference code and the serial number of your unit. Consult your dealer.

PRODUCT CONFIGURATION

- The unit is designed solely for the preservation of laboratory products, which requires various controls and warning in case of sudden alteration of temperature.













PRODUCTS MUST BE STORED IN ORDER TO ENSURE EFFICIENT AIR CIRCULATION INSIDE THE UNIT AND SHALL NOT COME OUT OF THE SHELF PERIMETER.

- All uses outside of manufacturer's intended use in section 1.1 shall be construed as "improper use" for which the manufacturer declines all responsibility.
- It's allowed to accommodate on the shelf a maximum of 30kg per shelf in a 12 cu.ft. (400 liters) model and a maximum of 45 kg per shelf in a 25 cu.ft (700 liters), 30 cu.ft (900 liters), 49 cu.ft.(1400 liters) and 72 cu.ft.(2100 liters) models according to the **UL471** regulation. [The most critical application in terms of weight (glass door/ stainless steel) has been tested following the Base standard UL 61010-1: The static weight was calculated considering a total load of 45 kg on each grid (exception 12cub.ft 30 kg). The dynamic load was considered only the weight in the cabinet without the load on the grids because the unit must be loaded when it is anchored to the wall, as reported in the user manual.]

MATERIALS AND REFRIGERANTS

Materials in contact or potentially in contact with products are in compliance with the relevant directives. The equipment designed and built so that contact parts can be cleaned before each use. The refrigerants utilized comply with established regulations.

WARNING LABELS	
Electrical Shock	LABEL A
	Use of this equipment involves power supplies which convert line voltage to low voltage power. Do not modify or use power supplies other than OEM equipment. Connection of the power supply may require a properly grounded receptacle. Potential for electrical shock or equipment damage exists if precautions are not followed.
Hot Surface	LABEL B
	Avoid contact with the hot surfaces potential for skin's burns.
Cold Surface	LABEL C
	Avoid contact with cold freezer surfaces potential for cold burns or skin sticking to cold surfaces.
Safety Alert	LABEL D
	Important operating instructions. To reduce the risk of injury or poor performance of the unit read the user manual before putting the equipment into operation.
Warning	
	Indicates an immediately hazardous situation, which if not avoided, will result in death or serious injury.
Caution	
	Indicates an immediately hazardous situation, which if not avoided, may result in minor to moderate injury

WARNING LABELS	
Battery	LABEL E
	Indicates the location of the back-up battery
Risk of fire	LABEL F
	Risk of fire or explosion. Flammable refrigerant used. Follow handling instruction carefully. To be repaired only by trained service Personnel. Do not puncture Refrigerant Tubing.
Grounding	LABEL G
	Indicates that the electrical components are electrically grounded.
Finger crashing	
	Important operating instructions. To reduce the risk of injury or poor performance of the unit read the user manual before putting the equipment into operation.

WARNING LABELS

This unit is intended for use in laboratories in commercial, industrial or institutional occupancies as defined in the Safety Standard for Refrigeration System,

Conformément à la Norme de sécurité pour les systèmes de réfrigération (ASHRAE 15), cette unité est destinée à un usage dans les laboratoires d'établissements commerciaux,

Refrigerating equipment

Refrigerating Equipment intended for laboratory use.

CAUTION - Risk Of Fire or Explosion due to Flammable Refrigerant Used. Follow Handling Instructions Carefully in Compliance with U:S: Government Regulations.

AVERTISSEMENT - Risque d'incendie ou d'explosion dû au fluide frigorigène inflammable utilisé. Suivre les instructions de manutention conformément à la réglementation gouvernementale des États-Unis.

Packaging markings

Packaging markings
(Label attached upon the cartoon box)

DANGER - Risk Of Fire or Explosion. Flammable Refrigerant Used. To Be Repaired Only By Trained Service Personnel. Do Not Puncture Refrigerant Tubing.

AVERTISSEMENT - Risque de due ou d'explosion. Fluide frigorigène inflammable utilisé. Doit être réparé uniquement par le personnel de service Formé. Ne pas perforer le tubage de réfrigérant.

Service markings 1

Service markings.
(Label located near the cooling unit compartment)

WARNING LABELS

CAUTION - Risk Of Fire or Explosion. Flammable Refrigerant Used. Consult Repair Manual / Owner's Guide Before Attempting To Install or Service This Product. All Safety Precautions Must be Followed

PRUDENCE - Risque de feu ou d'explosion. Fluide frigorigène inflammable utilisé. Consulter le manuel de réparation/guide du propriétaire avant de tenter d'installer ou de procéder à l'entretien de ce produit. Toutes les

Service marketing 2

Service markings
(Label located near the cooling unit compartment)

CAUTION - Risk Of Fire or Explosion. Dispose Of Properly In Accordance With Federal Or Local Regulations. Flammable Refrigerant Used.

PRUDENCE - Risque de feu ou d'explosion. Éliminer correctement conformément aux règlements fédéraux ou locaux. Fluide frigorigène inflammable utilisé.

Disposal

Disposal
(Marking attached upon the exterior of the cabinet)

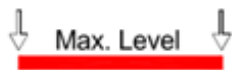

Max high load

INSTALLATION

TRANSPORTATION AND HANDLING

 **The equipment must be transported and handled exclusively in upright position, in observance of the instructions printed on the packing.**

This precaution is necessary to avoid contamination of the refrigerant circuit with compressor lube oil with resulting valve and heat exchanger coil failure and problems starting the electric motor or the risk of a gas leak. The manufacturer is not responsible for any problems due to transport executed in conditions other than those specified herewith.

The equipment is secured to a wooden pallet base, wrapped in a plastic film and packaged into a three waves carton box.

The equipment must be handled using a fork lift truck or a pallet truck with suitable forks (fork length at least equal to 2/3 length of unit).

POSITIONING

Incorrect positioning can cause damage to the equipment and generate hazardous conditions for personnel. The installer must therefore observe the following general regulations:

- Make sure you maintain a minimum of 2" (5 cm). clearance from the walls and 15" (40 cm) from the ceiling. The room must be well ventilated.
- Keep well away from sources of heat. Avoid direct sunlight
- Remove packing material.
- Remove accessories from inside the unit.
- Cartoon box or Wood base removal: using a hammer, tilt the cabinet to one side and loosen the two thread-forming screws, drag the cabinet from the back side holding the base still until the four castors have gone out from the containing holes, slightly tilt the cabinet backward and take the base away pulling it from the front side.

 Use gloves when handling the 3 Waves cartoon box or the wooden base to protect the hands from splinters.

- Position the equipment with the help of a level. Remove the protective PVC film from the external surfaces of the unit.
- Position the shelf runners in the holes in the uprights. Insert the shelves in the runners.

WIRING AND ELECTRICAL HOOK-UP

Receptacle installation and electrical wiring operations must be performed by a qualified electrician. For safety reasons adhere to the following indications:

- Check that the electrical plant is suitably sized for the absorbed power of the unit.
- If the electrical socket and the plug on the equipment power cord are incompatible, call technical service or your local distributor.
- The power cord set included with the appliance meets the requirements for use in the country of purchase. Use the power cord that shipped with the appliance (Nema 5-15). If this appliance is to be used in another country, purchase an AC power cord set that is approved for use in that country

! *The power cord must be rated for the product and for the voltage and current marked on the product's electrical ratings label. The voltage and current rating of the cord should be greater than the voltage and current rating marked on the product.*

- Do not use reductions or multi-way adapters (Fig.1)

! **It is important to connect the equipment correctly to an efficient earth system executed in compliance with the relevant legislation.**



Fig. 1

SET UP OPERATIONS

To avoid errors and accidents, perform a series of checks for possible damage sustained during transport, installation and hook-up operations before starting up the unit.

PRELIMINARY CHECKS

- Check the condition of the power cord (no cut or chaffing). Check that the door hinges and shelf support are stable.
- Check the door seals and shelves are not damaged (broken or scratched) and that the door closes and seals properly.
- Make sure all copper tubing, unions are in perfect condition.

FOR OPTIMAL PERFORMANCE

- Do not block the motor compartment air vents. Do not lay objects on the top of the equipment. Before storing products wait until they are cold.
- Arrange the products on suitable shelves or in containers. Do not place products directly on the base or against the walls, doors or fixed guards of the unit.
- Make sure doors are kept closed.
- Keep the defrost water drain outlet clear.
- Limit the frequency and duration of opening; each time the door is opened the internal temperature will alter.
- Load products at ambient temperature gradually to allow correct refrigeration. Perform routine maintenance regularly.

RE- INSTALLATION

Observe the following procedure:

- Switch off the equipment from the main switch.
- Disconnect the power cord from the electrical outlet.
- Handle the equipment in accordance with the instructions in Section 2.1.
- Follow the instructions in Section 2.2 for positioning and hook-ups in the new location.

STABILIZER BRACKET



Warning: To offset any potential for unit tipping, the unit must not be used or loaded for use without being secured to the wall with the wall bracket included. To mount the unit to the bracket and wall, please procure the proper screw and anchor type suitable for the wall material being mounted to.

INSTALLATION INSTRUCTIONS:

Installation instructions are provided for Wood/Concrete/Masonry walls. Any other type of construction may require special installation techniques as deemed necessary to provide adequate fastening of the Anti-Tip bracket to the walls. For installation on walls other than wood/ Concrete/Masonry walls, please contact technical support.

Step 1:

Each model has a galvanized iron crossbar at the top rear side. The crossbar is showed in the pic.1

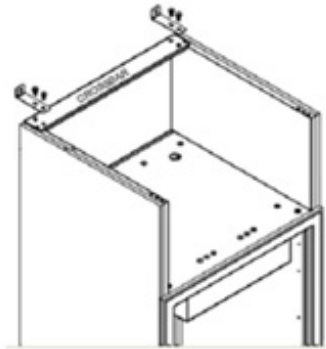

Pic 1 : Crossbar

Step 2:

In pic.2 is shown the galvanized iron bracket that will be used to fix the cabinet at the building.



Pic 2 : Bracket

Step 3:

this bracket must be linked to the crossbar by using two bolts as indicated. Provide 3Nm torque for the bolts.

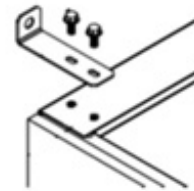

Pic.3 – Lag screw

Step 4:

- A. Mark the location of both holes on the wall.**
- B. Drill a hole in the base material (Masonry/ Concrete wall or wooden wall) using a hammer drill and a carbide-tipped masonry bit of radius 3/8” to a depth equal to 1.5” or more.**
- C. Clear the hole of all debris.**
- D. Place the leadwood screw anchor into both of the holes and, with light hammer blows, tap the anchor until it is flush with the surface of the base material.**

Step 5 :

Insert the lag screw through the bracket and into the anchor and tighten. Please provide appropriate torque for the screws.

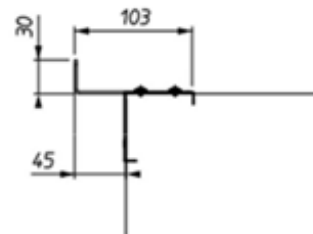

Pic 4 – Installation of bracket to the crossbar

SCRAPPING AND DISPOSAL

These units may contain materials, which at the end of the working life of the apparatus, must be disposed at one of the recycling centers nominated by your Local National Health Department or as specified by the law in force. Scrapping and disposal of the equipment must be carried out in full observance of established legislation in your country.

In particular, the apparatus may contain the following materials:

- Iron
- Copper
- Aluminium
- Non-biodegradable plastics
- Fibre glass for printed circuits
- Ferrite
- Batteries
- CFC-free refrigeration gas
- Electrical and electronic equipment (WEEE)

The manufacturer shall not be chargeable for any disposal of the apparatus at the end of its working life.



In line with EU Directive 2002/96/EC for waste electrical and electronic equipment (WEEE), this electrical product must not be disposed of as unsorted municipal waste. Please dispose of this product by returning it to your local municipal collection point for recycling

REMOTE ALARM CONNECTION

These units are equipped with a remote alarm plug for the connection to a remote alarm network.

The remote alarm plug is installed at the back of the cabinet near the main power plug enclosure and it is wired through a connection cable to the controller board.

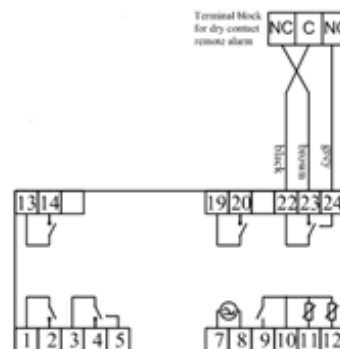

The Remote alarm contact is a Dry contact (low voltage: max 24VAc/VDc, 1A, SELV) and consist of three outputs: C (Common)/N.O. (Normally Opened Circuit) / N.C. (Normally Closed Circuit).

For the external network connection, fasten directly the pins according with the remote alarm network configuration. When an alarm occurs the contact relay switches from the N.C. position to N.O.

PROBE AND ACCESS PORT

As standard, the unit is equipped with a temperature probe inside the chamber. The probe monitors the temperature in the chamber and controls the operation of the compressors. The main probe also controls temperature alarms.

To install more probes, you can use the premade access port on the side of the unit. Un-cap the port plug, remove the insulation material and insert the probe.

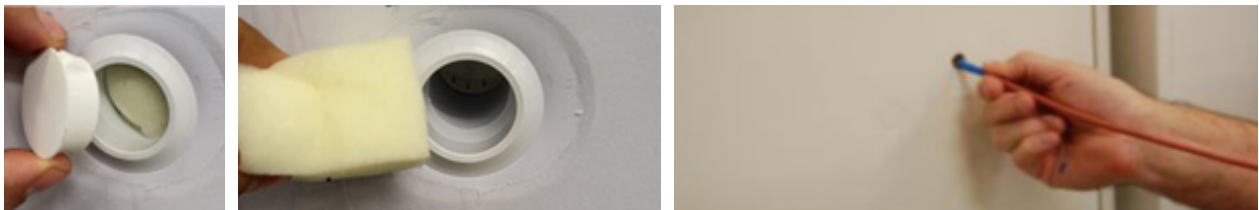

IMPORTANT NOTE: Always seal the port hole using the insulation material previously removed and applying some putty on both side of the port.



Never install probes through the door as this will deteriorate the functionality of the door gasket, increase the ice build-up and affect the temperature inside the unit.

OPERATION

Before switching ON the unit, check that the electrical connections have been made correctly and above all, that the ground connection is available and working properly.

Please read before using this manual

- This manual is part of the product and should be kept near the instrument for easy and quick reference.
- Digital controller with defrost and fans management shall not be used for purpose different from those described hereunder. It cannot be used as a safety device.
- Check the application limits before proceeding.

Safety precautions

- Check the supply voltage is correct before connecting the instrument.
- Do not expose to water or moisture: use the controller only within the operating limits avoiding the temperature changes with high atmospheric humidity to prevent formation of condensation.



Warning

- Disconnect all the electrical connections before any kind of maintenance.
- In case of failure or faulty operation contact technical service or dealer.
- Consider the maximum current which can be applied to each relay.
- Ensure that the wired for probes, loads and the power supply are separated and far enough from each other, without crossing or intertwining.

CONTROLLER

The controller is a microprocessor-based controller suitable for normal and low temperature air- ventilated application. It is made of a split PCB installed in the electrical box and a remote HMI display for user-friendly operations. It also has a BLETOOTH connection for the user to interact in real time with the unit and access the data logs stored on the controller by an App called APPLICA.







Controller feature Split PCB	
	<ul style="list-style-type: none"> - Switching power supply: 115-230Vac with high and low voltage detection; - NFC; - 2 probes inputs, 1 digital input and 1 multifunction input; - 6 relays (30A, 16A, 4 x 8A); - Removable screw or faston terminals; - Bluetooth with RTC function; - JST terminal at front for connection to remote display. - 1 Backup battery port;
Remote HMI terminal	
	<p>Low voltage power supply from the controller;</p> <ul style="list-style-type: none"> - NFC; - Mini JST terminal for connection to the controller; - 6 backlit touch buttons; - Bluetooth;

User terminal



The user terminal can only be used to set the User parameters and display the value of the probes connected to iJS PCB.
At start-up, the user terminal briefly shows the firmware version and then the control probe temperature.

Icon/button	Description	On	Flashing
	Minimum temperature	Direct access to the minimum recorded temperature	--
	Reset minimum and maximum temperature	Reset minimum and maximum recorded temperatures (Require confirmation)	--
	Maximum temperature	Direct access to maximum recorded temperature	--
	Set point/ Up arrow	Increase value Scroll menu	--
	Program	Pressed briefly: •enter menu branch; •save value and return to the parameter code; Pressed and held (3 s): •from standby, unlock keypad and enter programming mode; •when scrolling, go to the previous parameter.	--
	Lights/ Down arrow	•Decrease value or scroll menu •Lights on •Switch lights on/off	--
	Battery test	Battery test in progress	Starting

Icon/button	Description	On	Flashing
	Alarm log	<ul style="list-style-type: none"> •Logged alarms present •Direct access to the alarm log menu 	--
	Compressor	Active	Awaiting
	Battery status	Charging	Needs re- placement
	Anomalous temperature	Anomalous temperature alarms present	--
	°C	Unit of measure °C	--
	°F	Unit of measure °F	--
	Service maintenance	Active alarms	--

Navigation and actuator/function direct activation mode

The below figure shows how to navigate between the screens on the display; specifically, the grey area shows programming mode for setting the parameters.

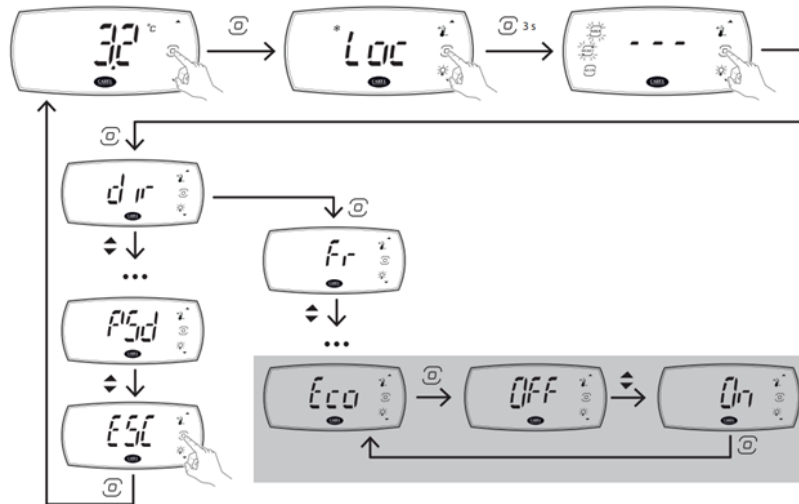









At the startup of the unit the user terminal briefly shows the firmware version and then it displays the control temperature.



When pressing any button, the display shows the message “Loc” meaning that the keyboard is locked and the icons corresponding to the currently-active actuators/functions come on to indicate the status of the unit. By pressing the  (PRG) key for 3 s, the display shows 3 dashes in sequence and enters the actuator/function direct activation mode. In this mode:

- the keys that are steady ON indicate that the corresponding actuator/function is active; press the button to deactivate it or to enter the function;
- the keys that are flashing indicate that the actuator/function is not active and can be activated by pressing the key;

When pressing the key, the display shows information on the status of the selected actuator/function:



-  key gives direct access to the Minimum temperature recorded;
-  key gives direct access to the Maximum temperature recorded;
-  key resets the minimum and maximum temperature recorded;
-  key gives direct access to the set point settings: set the new value by using the upper or down key  then save the new set point value by pressing the  PRG key;
-  key turns ON/OFF the interior light of the cabinet;
-  key starts the battery test;
-  key gives direct access to alarm log.

Programming mode from the user terminal

From the standard display press the  PRG key for 3 seconds in order to enter the actuator/function direct activation mode. Then press the  PRG key again to enter the programming mode where the unit's main operating parameters can be set.



To navigate the menu tree, use the following keys:

- UP and DOWN  /  to navigate the menu and set the values;
- PRG  to enter the menu items and save the changes made;
- Select the menu item or ESC to return to the previous branch.

The menu items available and parameters visible on the user terminal are listed in the below table:

dir <i>Direct function</i>	CtL <i>Control</i>	Pro <i>Display probes</i>	HcP <i>Temp alarms</i>	CnF <i>Configuration</i>	ALM <i>Alarms</i>	PSD	ESC
OnF	St	/5	HAn	Hb	AH		
Fr	Sth	ESC	HEn	ESC	AL		
dEM	HU		rHP		Ad		
Eco	ESC		ESC		Add		
SrG					rSA		
Sm					ESC		
Sd							
Sc							
SPr							
boE							
ESC							

Direct functions (dir label)

- OnF: This function allows to switch ON or OFF the controller;
- Fr shows the firmware version;
- dFM: This function starts a manual defrost;
- Eco: This function activates the Eco mode (the controller will work with an higher set point ($St+r4$) with a differential of regulation defined by the parameter r4d. Opening the door will cause the changeover from ECO mode to normal operation).
- SrG: this label displays the temperature value read by the Control probe;
- Sm: this label displays the temperature value read by the outlet probe (or air probe, being the same of Control probe)
- Sd: this label displays the temperature value read by the Evaporator probe (or Defrost probe);
- Sc: this label displays the temperature value read by the Condenser probe;
- SPr: this label displays the temperature value of the Product probe;
- boF: this function activates the battery backup;

Control functions (Ctl label)

- St: Set point temperature setting;
- Sth: Humidity set point setting;
- HU: Humidity level setting;

Display probes functions (Pro label)

- /5: Temperature unit of measure setting (0=°C, 1=°F);

Temperature alarm functions (HcP label)

- HAn: Number of HA (High temperature) alarm recorded setting;
- HFn: Number of HF (High temperature after blackout) alarm recorded setting;
- rHP: Enable rest of the temperature alarm logs;

Configuration functions (CnF label)

- Hb: Enable the buzzer (0=disabled; 1=enabled);

Alarms functions (ALM label)

- AH: Relative high temperature alarm threshold;
- AL: Relative low temperature alarm threshold;
- Ad: Temperature alarm delay;
- Add: Temperature alarm delay after door opening;
- rSA: Alarm reset activation (0=NO, 1=Yes);

PSD is the service parameters section and it is protected by a service password.

ALARMS AND SIGNAL



Signals

Signals are messages shown on the display to notify the user of the procedures in progress or to confirm keypad input:

Display label	Description
Ble	Bluetooth connection in process
dEE	Running defrost cycle
Loc	Display locked
Off	Switch OFF
On	Switch ON
tSt	Test outputs via BMS serial port active

Alarms

The controller can display two types of malfunctions:

- **warnings:** when this type of error occurs, the alarm code is displayed on the controller screen, alternating with the control temperature, and the “Service” icon  is shown on the display, however the buzzer does not sound and the alarm relay is not activated;
- **alarms:** when this type of error occurs, the alarm code is displayed on the controller screen, alternating with the control temperature, and the “Service” icon  is shown on the display, the buzzer sounds and the alarm relay is activated;

Both warnings and alarms can be reset automatically, manually or semi-automatically:

- automatic, when the cause is no longer present, the alarm also ceases;
- manual, when the cause is no longer present, the alarm remains active until manually reset by parameter;
- semi-automatic, reset is automatic 3 times in an hour, after which manual reset is required.

During an ongoing alarm pressing any button mutes the buzzer.

If more than one error occurs, these are displayed in sequence.

When an alarm is cleared, it is stored in the alarm log containing a maximum of five alarms (then the new one is overwritten over the oldest one).

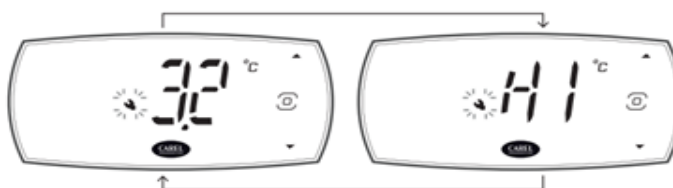

Alarms table

Display code	42Log code38	Description
Afr	29	Frost protection
bAt	39	Battery faulty or not connected
bLC	40	Blackout in progress
btS	41	Battery test in progress
CE	28	Configuration write error
cht	17	High condenser temperature warning
CHt	18	High condenser temperature alarm
COM	34	VCC communication error
da	14	Delayed alarm from external contact
dor	15	Door open
E1	1	Probe 1 faulty or disconnected
E2	2	Probe 2 faulty or disconnected
E3	3	Probe 3 faulty or disconnected
E4	4	Probe 4 faulty or disconnected
E5	5	Probe 5 faulty or disconnected
E6	6	Probe S1H faulty or disconnected
E7	7	Probe S2H faulty or disconnected
Ed1	10	Defrost terminated after maximum time
Ed2	11	Defrost on second evaporator terminated after maximum time
EHI	36	High power supply voltage alarm
ELO	37	Low power supply voltage alarm
Etc	9	Clock error
GHI	19	Generic alarm high threshold
GLO	20	Generic alarm low threshold
HA	21	Type HA anomalous temperature alarm (high temperature during normal operation)
HF	22	Type HF anomalous temperature alarm (high temperature after blackout)

Display code	Log code	Description
HI	24	High temperature
IA	13	Immediate alarm from external contact
LO	23	Low temperature
LP	32	Low pressure
Ltc	42	Low temperature line compressor failed to start
MAAn	38	Output status overridden in manual mode
rE	12	Control probe faulty or disconnected
rSE	31	Refrigerant leak alarm
SF	27	Configuration not completed correctly
SrC	35	Maintenance request
UCF	33	VCC operation error

APPLICA APP

The *APPLICA* app from CAREL can be used to monitor and configure the controller from a mobile device via BLE (Bluetooth Low Energy). The app is compatible for devices Android 5.1, iOS 10, Bluetooth® 4.0 and higher. You might notice that CAREL provides two different apps for their devices *APPLICA* and *CONTROLLA*. For this unit the *APPLICA* app must be used.

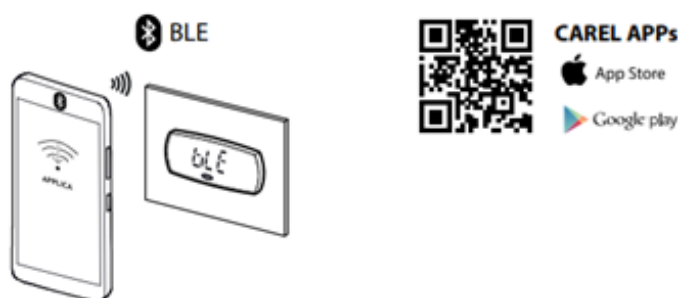

Once downloaded the *APPLICA* app from the Apple store or Google Play, activate the BLE on your device and start the App.

Select Bluetooth as the type of connection in the bottom bar of the screen. A list of devices available within a range of 10m appears and select the one of your interests:

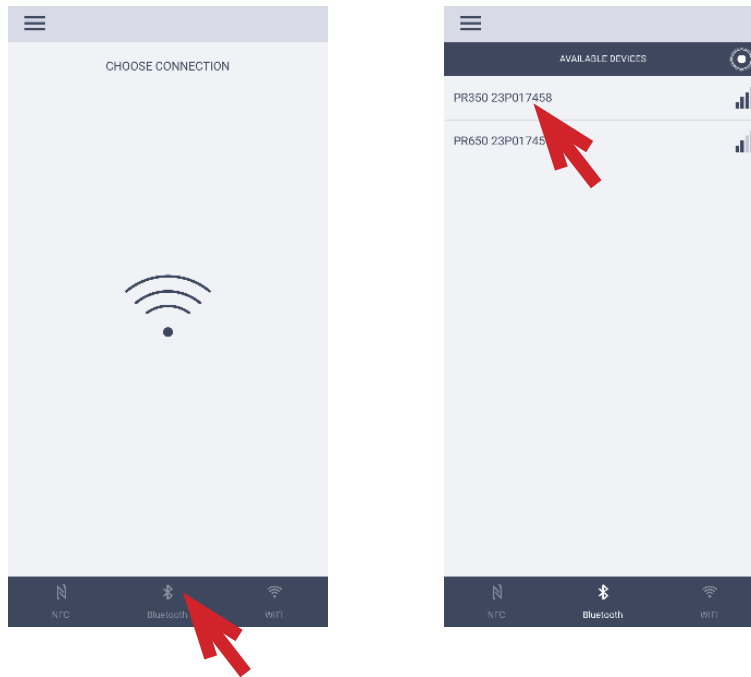

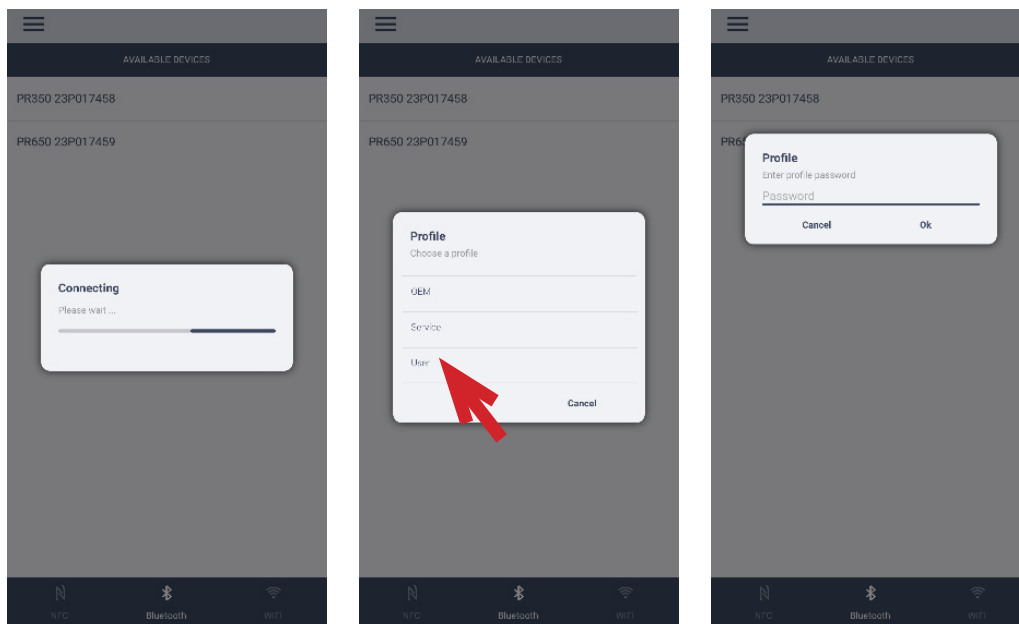

The App starts to link the device and once the connection is established it ask you to choose a profile. Choose User and enter the password 000.



The Home page will be displayed showing the control probe reading temperature.

Across the Home page the following action are possible:

- Switching ON and OFF the controller by the ON/ OFF button  ;
- Switching ON/OFF the interior light by the light button  ;
- Switching ON/OFF ECO-mode by the ECO-mode button  ;

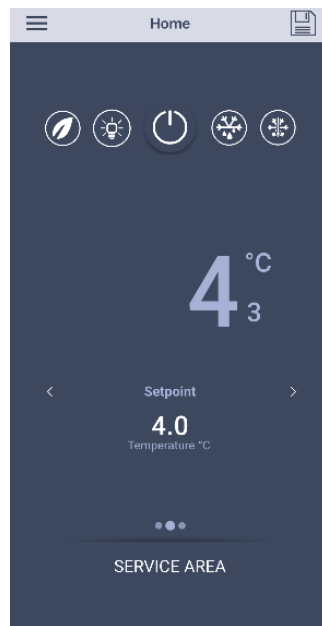

- Change the Set point temperature: select the SETPOINT, change the value using the keyboard and press OK to apply the new temperature value.

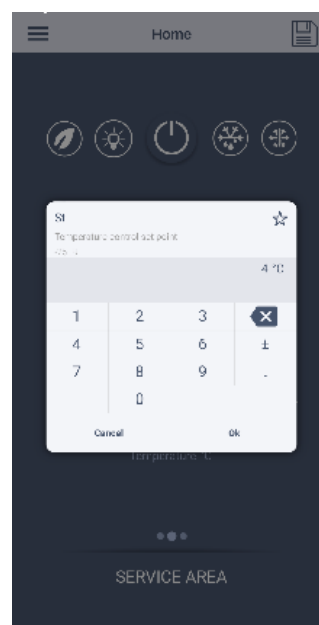
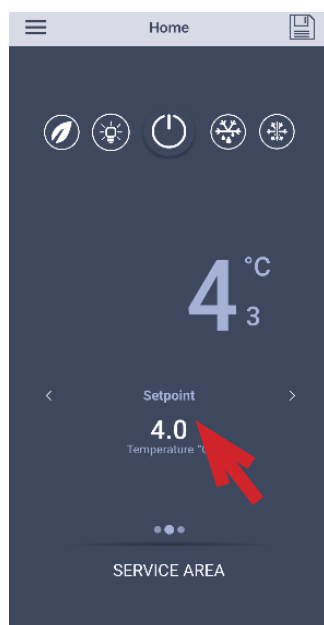

- Press the < and > symbol on the screen and more information about Status and Probes & Digital inputs will appear on the screen.

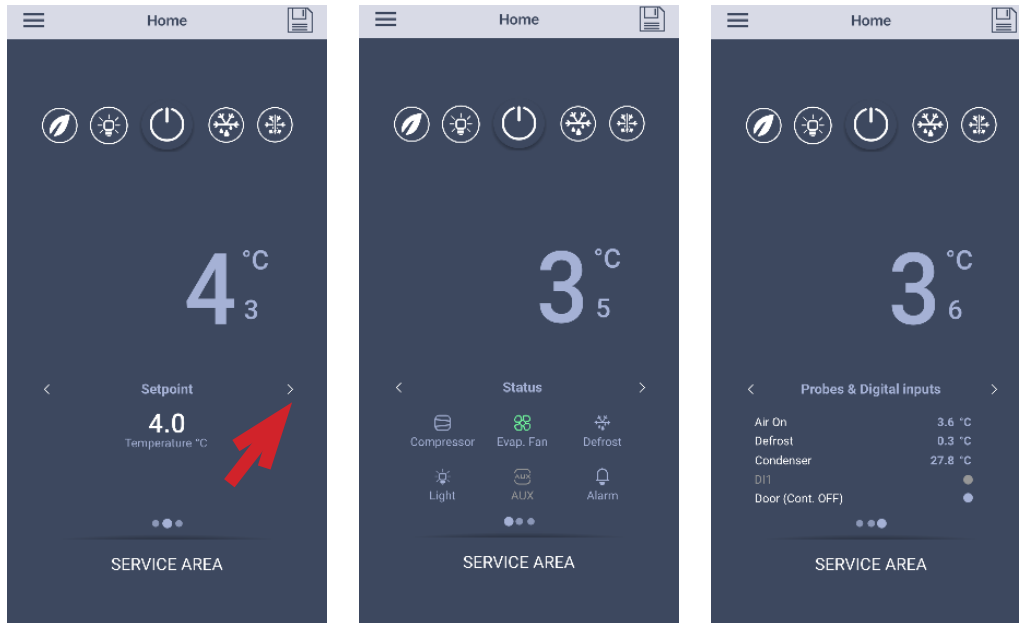

- Display the ongoing alarm and the alarm history:

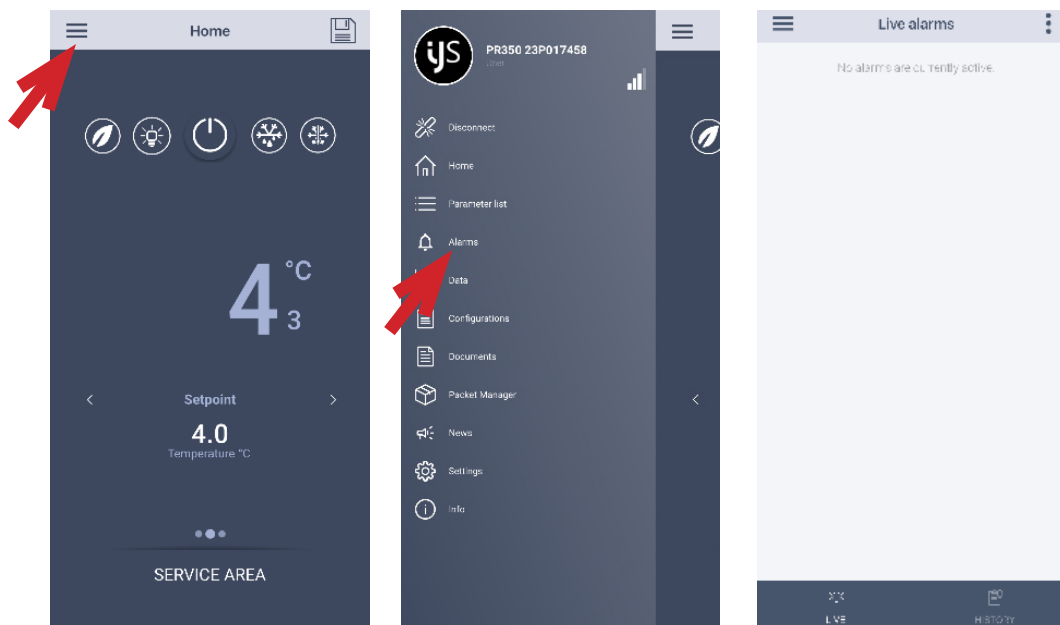

• Display live data graph:

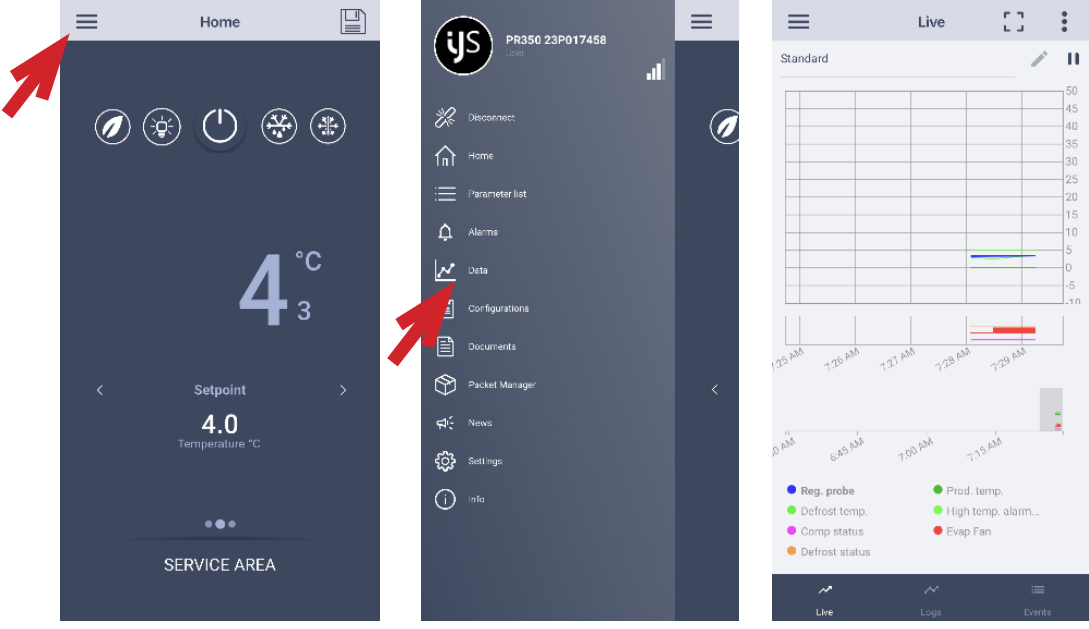

• Display and export the temperature logs:

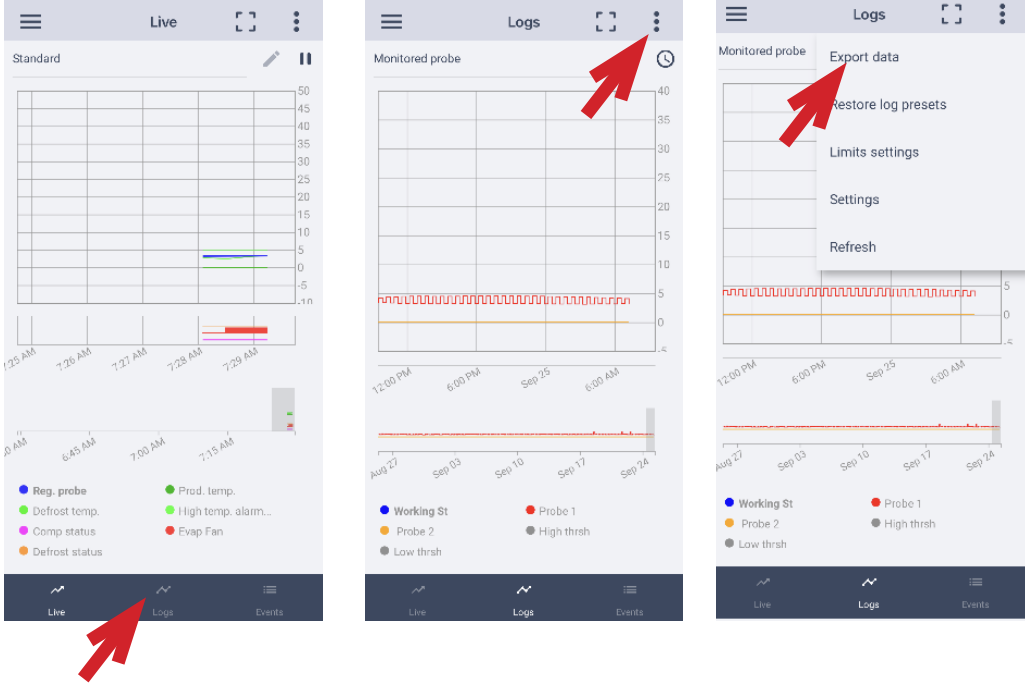

MAINTENANCE AND REPAIR

Maintenance and repair must be carried out by qualified personnel authorized by the manufacturer.



The manufacturer declines any responsibility for jobs carried out by unauthorized personnel or the use of non-original spare parts.

RUTINE MAINTENANCE



Prohibited to remove the guards and safety devices: It's strictly forbidden to remove guards or safety devices when performing routine maintenance operation. The manufacturer disclaims all liability that may arise this regulation is not observed.

In case of FIRE:

- Disconnect the unit from the electrical power socket.
- Do not use water to extinguish the fire.
- Use powder or foam extinguishers.

Cleaning the interior and exterior of the appliance

The appliance is designed for the laboratory product storage so it is important to keep it clean. The equipment is thoroughly cleaned at the factory before being shipped. We recommend, however, to clean the interior cabinet before the first start up of the appliance.

Before attempt any cleaning operation make sure the power cord is disconnected.

- Cleaning product: use soft clean cloth wet with water and neutral detergent only. Do not use solvent or bleach.
- Rinsing: use a cloth or sponge soaked with fresh clean water. Do not use water jet.
- Frequency: once a week or at different intervals in accordance with the type of product.

Condenser cleaning

The condenser is a heat exchanger. If it is dirty or clogged the air cannot circulate freely through the same, it cannot discharge heat properly so reducing proportionally the performance and the efficiency of the refrigeration system.

FOR THOSE REASONS IT IS IMPORTANT TO KEEP CLEAN THE CONDENSER COIL, TYPICALLY MONTHLY.



Always switch off the unit and disconnect power cord before cleaning, it is dangerous to do it with power ON: fan may start suddenly at any time.

Use a convenient ladder to reach the condenser. Use an air jet or vacuum with a soft dry brush if necessary and remove any dust or fluff from the heat exchanger fins.

After cleaning, start the equipment.



During the cleaning operation wear gloves and safety glasses to protect yourself from any injury

TROUBLESHOOTING

The table shows the most frequent break downs, possible causes and relative remedies:

PROBLEM DESCRIPTION	POSSIBLE CAUSE	SOLUTION
The appliance does not come on	The main switch is "off"	Main switch "on"
	There is no tension	Check plug, socket, electric connection
	Other	Contact technical assistance
The refrigerator unit does not start	Set temperature is reached	Set new temperature
	Defrosting is in operation	Wait for end of cycle, switch off and switch back on
	Control Panel is broken	Contact technical assistance
	Other	Contact technical assistance
The refrigerator is continuously working but does not reach the set temperature	Room is too hot	Air better
	Condenser is dirty	Clean condenser
	Refrigerant fluid is insufficient	Contact technical assistance
	Condenser fan has stopped	Contact technical assistance
	Door not properly closed	Check door seals
	Evaporator is frosted up	Manual defrosting
	Defrost valve is open	Contact technical assistance
Refrigerator does not stop at set temperature	Control Panel is broken	Contact technical assistance
	Temperature probe is broken	Contact technical assistance
	Door is not airtight	Close door

PROBLEM DESCRIPTION	POSSIBLE CAUSE	SOLUTION
Ice blocks on evaporator	Improper use	Contact technical assistance
	Control Panel is broken	Contact technical assistance
Appliance is noisy	Appliance not levelled	Check that appliance is level.
	Contact with external bodies	Check that no tube or ventilator fan is in contact with external bodies.
	Screws or nuts loose	Tighten
	Other	Contact technical assistance
Safety DC fan does not work	Fan disconnected	Re-wire the fan to the electrical strip contact
	Stuck fan	Replace the fan
	Fan motor damaged	Replace the fan

IN ORDER TO GUARANTEE THE EFFICIENCY OF THE APPLIANCE AND ITS CORRECT FUNCTIONING THE MANUFACTURER'S INSTRUCTIONS MUST BE FOLLOWED AND PERIODIC SERVICING MUST BE CARRIED OUT BY PROFESSIONALLY QUALIFIED PERSONNEL.

(LEGAL REQUIREMENT FOR THE PREVENTION OF ACCIDENTS AT WORK AND THE INSTALLATION OF ELECTRICAL APPLIANCES) IT IS OBLIGATORY TO BE IN ACCORDANCE WITH POWER SUPPLY REGULATIONS

SPARE PARTS

SUPPLY OF ORIGINAL SPARE PARTS

For the substitution of any parts, spares can be obtained at Arckito distributors, on giving

- Serial number and year of manufacture (look at the name plate placed on the product);
- Component identification number.



Any malfunctioning due to non-original spare parts will not be recognised by our technicians.

Arctiko strive for day-to-day delivery of spare parts. However, some special parts may take longer due to production time. Arctiko guarantees availability of spare parts for all units for at least 10 years after the delivery.

AFTER SALES

If you would like more information about your device or you would like to purchase spare parts or additional equipment, please contact your local Arctiko service team. Always have serial number of the unit and model ready before contacting the service.

WARRANTY

For warranty information, Arctiko refers to our terms and conditions.