



**SONARIS**  
**Sonar**  
**Stadiometer**  
**Owner's Manual**



## INTRODUCTION

Thank you for purchasing our Detecto SONARIS Sonar Stadiometer. It has been manufactured with quality and reliability and has been tested before leaving our factory to ensure accuracy and dependability for years to come.

This manual is provided to guide you through installation and operation of your SONARIS Stadiometer. Please read it thoroughly before attempting to install or operate your Stadiometer and keep it handy for future reference.

## COPYRIGHT

All rights reserved. Reproduction or use, without expressed written permission, of editorial or pictorial content, in any manner, is prohibited. No patent liability is assumed with respect to the use of the information contained herein.

## DISCLAIMER



While every precaution has been taken in the preparation of this manual, the Seller assumes no responsibility for errors or omissions. Neither is any liability assumed for damages resulting from use of the information contained herein. All instructions and diagrams have been checked for accuracy and ease of application; however, success and safety in working with tools depend largely upon the individual accuracy, skill, and caution. For this reason, the Seller is not able to guarantee the result of any procedure contained herein. Nor can they assume responsibility for any damage to property or injury to persons occasioned from the procedures. Persons engaging in the procedures do so entirely at their own risk.

## FCC COMPLIANCE STATEMENT

This equipment generates, uses and can radiate radio frequency, and if not installed and used in accordance with the instruction manual, may cause interference to radio communications. It has been designed within the limits for a Class A computing device pursuant to Subpart J of Part 15 of FCC rules to provide reasonable protection against such interference when operated in a commercial environment. Operation of this equipment in a residential area may cause interference in which case the user will be responsible to take whatever measures necessary to correct the interference.

You may find the booklet "How to Identify and Resolve Radio TV Interference Problems" prepared by the Federal Communications Commission helpful. It is available from the U.S. Government Printing Office, Washington, D.C. 20402. Request stock No. 001-000-00315-4.

<b>Serial Number</b> _____
<b>Date of Purchase</b> _____
<b>Purchased From</b> _____
_____
_____
_____
RETAIN THIS INFORMATION FOR FUTURE USE

<b>PRECAUTIONS</b>	
Before using this product, read this manual and pay special attention to all "NOTIFICATION" symbols:	
	IMPORTANT
	ELECTRICAL WARNING

## PROPER DISPOSAL

When this device reaches the end of its useful life, it must be properly disposed of. It must not be disposed of as unsorted municipal waste. Within the European Union, this device should be returned to the distributor from where it was purchased for proper disposal. This is in accordance with EU Directive 2002/96/EC. Within North America, the device should be disposed of in accordance with the local laws regarding the disposal of waste electrical and electronic equipment.

It is everyone's responsibility to help maintain the environment and to reduce the effects of hazardous substances contained in electrical and electronic equipment on human health. Please do your part by making certain that this device is properly disposed of. The symbol shown to the right indicates that this device must not be disposed of in unsorted municipal waste programs.



## CAUTION



**CAUTION:** RISK OF EXPLOSION IF BATTERY IS REPLACED BY AN INCORRECT TYPE. DISPOSE OF USED BATTERIES ACCORDING TO THE INSTRUCTIONS.

**ATTENTION:** RISQUE D'EXPLOSION SI LA BATTERIES EST REMPLAC'E PAR UN TYPE INCORRECT. REJETEZ LES BATTERIES UTILISE'ES SELON LES INSTRUCTIONS.

# SPECIFICATIONS

Height Rod Type:	Sonar (for truly touchless digital accuracy)
Height Rod Measures:	1 to 9 ft (30 to 275 cm)
Height Units:	feet/inches, inches, centimeters, and millimeters
Display Type:	0.75 in (19 mm) high, seven segment LCD with backlight
Keys:	Mechanical switch type, Power, Units
Power Requirements:	Included 100 to 240 VAC, 50/60Hz, 12 VDC 1A wall plug-in UL/CSA listed AC power adapter (Cardinal part number 6800-1045) or 6 "AA" cell Alkaline, Ni-Cad, or NiMH batteries ( <i>not included</i> )
Operating Environment:	Operated temperature range: 14 to 104 °F (-10 to +40 °C) Humidity: 0 to 90% non-condensing

## Standard Features:

- Instant digital height readouts without pressing a single key
- Auto calibrate (or manual calibration) to current position allowing it to be completely portable
- Toggle between the four unit readings by simply pressing the Units key
- Can used stand-alone on a desk or tabletop without mounting for true mobility
- May be wall mounted

## Operating Environmental Conditions

The Detecto SONARIS Sonar Stadiometer has been designed to operate under the following environmental conditions:

- For indoor use only.
- Never allow unit to get wet.
- Ambient temperature range of 14 to 104 °F (-10 to +40 °C)
- The unit should be placed out of direct sunlight.
- Keep the area around the unit clear. Movable objects that might interfere with the sound waves of the sensor should be removed from a 6-foot radius.
- Do not place the unit directly in front of a heating or cooling vent. Such a location will subject it to sudden temperature changes, which may result in unstable height readings.
- Insure that the unit has good, clean AC power, and is properly grounded. In areas subject to lightning strikes, additional protection to minimize lightning damage, such as surge suppressors, should be installed.
- Make certain the AC Power Adapter cord is out of the way of normal traffic to avoid a trip hazard.

# UNPACKING

Carefully remove the SONARIS Sonar Stadiometer from the shipping carton and inspect it for any damage that may have taken place during shipment. *Keep and use the original carton and packing material for return shipment if it should become necessary.* The purchaser is responsible for filing all claims for any damages or loss incurred during transit.

# INSTALLATION

## Placing the SONARIS

The SONARIS should be placed on a stable, vibration-free, level surface such as a table or desktop. It can also be mounted on a wall. The location chosen should be in a safe area where it will not be in the way of normal traffic. It should be free of temperature extremes and water and not subjected to direct sunlight. The SONARIS should be placed (or mounted) where the display is easily viewed and within easy reach of the operator.

Regardless of where you place or mount the SONARIS, keep the area around it clear. Movable objects that might interfere with the sound waves of the sensor should be removed from a 6-foot radius.



**IMPORTANT: The SONARIS cannot be set directly on the floor.**

## Wall Mounting

The SONARIS may be mounted on a wall using the two holes in the back of the enclosure and two #10 screws placed 2.00 inches (51 mm) apart in the wall.

1. Choose the location to mount the SONARIS on the wall. Make certain the structure and mounting screws are of sufficient strength to support the SONARIS.
2. Install two #10 screws placed 2.00 inches (51 mm) apart in the wall.
3. Turn the SONARIS around to locate the slotted holes in the back of the enclosure.
4. Place the large end of the slotted holes on the back of the enclosure over the screw heads in the wall.
5. Gently pull down to secure the SONARIS to the wall.

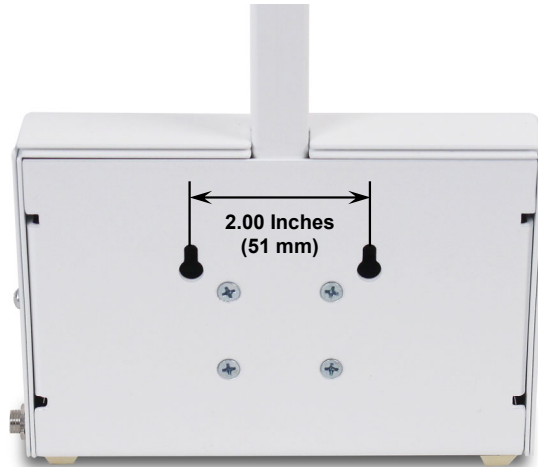

## Choosing a Height

The SONARIS will measure heights of a wide range but there are some limits. Two major factors should be considered:

- **Maximum Height** – The SONARIS cannot measure heights that are closer than 7 inches to the sensor. For example, if the height of the sensor were 94 inches from the floor, then the tallest measurement it could make would be 87 inches. To measure a person that is taller, the sensor will have to be mounted higher.

**NOTE:** When mounting the SONARIS, the height of the sensor cannot exceed 115 inches from the floor.

- **Minimum Height** – The minimum height the SONARIS can measure is 12 inches.

# POWERING THE SONARIS

## AC Power Adapter

To power the SONARIS using the included 12VDC wall plug-in UL/CSA listed AC power adapter, connect the plug from the adapter into the power jack on the side of the unit and then plug the power adapter into the proper electrical outlet. On models requiring 230 VAC, it is the customer's responsibility to obtain the correct power adapter plug.



AC Power Adapter

## Batteries

The SONARIS can use six "AA" size Alkaline, Ni-Cad, or NiMH batteries (*not included*). You must first obtain, and install batteries before operations can begin. Batteries are contained in a battery holder inside the unit base. Turn the SONARIS on its side to access the battery holder in the bottom of the unit base.



**CAUTION!** The SONARIS can be operated from Alkaline, Ni-Cad or NiMH batteries. All six batteries must be of the same type. They must all be Alkaline, all Ni-Cad, or all NiMH. **DO NOT** mix Alkaline and Ni-Cad or NiMH batteries.



**NOTE:** The SONARIS *does not* have a battery charging circuit. Should you wish to use Ni-Cad or NiMH batteries, they must be *fully* charged before installing. When discharged, Ni-Cad or NiMH batteries must be removed and placed in an external charger to recharge.

## Battery Status

The battery status will be displayed when batteries are installed. The battery bar graph on the display indicates the battery capacity in five steps:

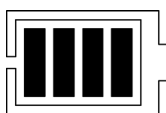

- 4 segments - The full battery capacity is available.
- 3 segments - The battery is at 80% of capacity
- 2 segments - The battery is at 60% of capacity.
- 1 segment - The battery is at 40% capacity.
- 0 segments - The battery is at less than 20% capacity.

When the batteries are near the point they need to be replaced (Alkaline) or recharged (NiCad or NiMH), the battery status symbol will not show any bars. If the battery voltage drops too low for accurate height measurement, the SONARIS will automatically shut off and you will be unable to turn it back on.

### Using Alkaline Batteries

When no bars are shown on the battery status symbol, press the  key to turn the SONARIS off, remove the old batteries and replace with new ones.

### Using NiCad or NiMH Batteries

When no bars are shown on the battery status symbol, press the  key to turn the SONARIS off, remove the discharged batteries and replace with fully charged ones. Place the discharged batteries in an external charger to recharge.

## Battery Installation/Replacement

To install or remove the batteries, the following steps should be followed:

1. Make sure the AC power adapter is unplugged.
2. Turn the unit on its side.
3. Locate the rectangular panel on the unit base.
4. To install or replace the batteries, first remove the battery holder cover by pushing in on the tab and lifting up. Refer to Figure No. 1.
5. If installing new batteries, proceed to step 6. If replacing the batteries, remove all six batteries from the battery holder and then proceed to step 6.
6. Install the six new "AA" size batteries in the holder, noting the polarity markings located in the battery holder. Refer to Figure No. 2.
7. After placing all six batteries in the holder, replace the battery holder cover on the unit base and turn the unit upright.



Figure No. 1



Figure No. 2

8. Press the  key.
9. If the unit turns on, batteries have been installed correctly. If not, remove the battery holder cover and check for one or more improperly positioned batteries.
10. The SONARIS is now ready for operation.

## BATTERY SAVER FEATURE

This SONARIS is equipped with a battery saver feature that helps prolong battery life by turning off the backlight while measuring a height and turning the unit off when not in use.

If the SONARIS is battery powered, the following power saving features will be implemented:

- The backlight will turn itself off until a height is measured and locked. After the height is locked, the backlight will stay on for eight seconds.
- The SONARIS will shut-off five minutes after the last locked height measurement.

## KEYPAD FUNCTIONS



**DO NOT** operate the keys with pointed objects (pencils, pens, etc.). Damage to keys resulting from this practice is **NOT** covered under warranty.



This is the **POWER** key. With the SONARIS off, pressing this key will apply power to the SONARIS and turn on the display. If the SONARIS is already on, pressing the key will turn it off.



This is the **UNITS** key. The SONARIS can display the measured height in feet/inches, inches, centimeters, and millimeters. To change displayed units, you simply press the **UNITS** key to toggle between unit readings.

## ANNUNCIATORS

The annunciators are displayed to show that the unit is in the mode corresponding to the annunciator label or that the status indicated by the label is active.

' "

The ( ' ) feet and ( " ) inches annunciators are turned on when the displayed height measurement is in feet and inches.

"

This annunciators is turned on when the displayed height measurement is in inches.

cm

This annunciator is turned on when the displayed height measurement is in centimeters.

mm

This annunciator is turned on when the displayed height measurement is in millimeters.



The low battery annunciator is located in the upper left corner of the display. It is used to indicate the battery status. Refer to Battery section of this manual for more details.



# OPERATION

1. Press  key to turn the SONARIS on.
2. Have the patient step under the sensor, stand still, look straight-ahead, and not down at the SONARIS display.
3. The displayed height will update until it locks onto the patient's height.
4. Once the height is locked onto, a beep will sound. **NOTE:** The height will remain locked while the patient is under the sensor.
5. Read and record the height displayed.
6. Have patient step away from the sensor.
7. Once the patient steps away, the display will automatically return to a zero height display

## NOTES:

- It is recommended that a height station mark the floor in some way to show the patient where to stand (the location where the crown of the head is directly under the sensor). Standing too far away from the sensor will make heights appear short.
- There is a natural tendency for the patient to look down at the height display during measurement. In order to obtain an accurate height measurement, instruct the patient to look straight ahead and not down at the display. Looking down can reduce the measured height by up to an inch.

## Selecting Units

The SONARIS can display the measured height in feet/inches, inches, centimeters, and millimeters. To change the displayed measurement, press the **UNITS** key to toggle between the four available units.

- Feet and Inches • Inches • Centimeters • Millimeters

# CALIBRATION

Movable objects that might interfere with the sound waves of the sensor should be removed from a 6-foot radius. Objects that are not easily movable (walls, a desk, large heavy objects that stay in one-spot) can be left in place. These larger objects will be masked away in the calibration process.



**NOTE: The keys are not to be operated with pointed objects (pencils, pens, fingernails, etc.). Damage to the keys resulting from this practice will NOT be covered under warranty.**

## To Begin

1. Press the  key to turn the SONARIS on.
2. The SONARIS will perform a display test (turn on all segments) and then change to the show the firmware version.
3. Press the **POWER** and **UNITS** keys at the same time to begin the calibration.
4. The display will flash *Stand* and *Err* (twice) indicating you should step away from the sensor at a distance of at least 6 feet.
5. After approximately four seconds, *Err* will begin flashing on the display.
6. At this time, the sensor is recording data on its surroundings and auto-detecting the distance to the floor.
7. Calibration will take approximately ten seconds.
8. When calibration is complete, the display will change to *done* and a beep will be heard.
9. The SONARIS will return to a zero height display and is now ready for normal operation.



**IMPORTANT! Any time the SONARIS is moved to a different location or remounted, it must be recalibrated.**

## BEFORE YOU CALL FOR SERVICE

Problem	Possible Solutions
Unit does not turn on	<p>AC Operation:</p> <ul style="list-style-type: none"> <li>• Is AC power supply fully inserted into wall receptacle?</li> <li>• Check wall receptacle for proper AC power. Try another electrical appliance in same receptacle. Does it work?</li> <li>• Check circuit breaker.</li> <li>• Has there been power failure?</li> </ul> <p>Battery operation:</p> <ul style="list-style-type: none"> <li>• Check if batteries are installed and correctly.</li> <li>• If Alkaline, remove old batteries, and replace with new ones.</li> <li>• If NI-CAD or NiMH, remove discharged batteries and replace with fully charged ones. Place discharged batteries in an external charger to recharge.</li> </ul>
Incorrect height is displayed	<p>Instruct patient to look straight ahead and not down at unit display. Looking down can reduce the measured height by up to an inch.</p> <p>Insure that movable objects that might interfere with the sound waves of the sensor are removed from a 6-foot radius of the unit.</p> <p>Has the SONARIS been moved to a different location or remounted? If so, it <u>must</u> be re-calibrated.</p>

## CARE AND CLEANING



**NOTE:** The SONARIS contains no user-serviceable parts and maintenance should be limited to an occasional cleaning and battery replacement as required.

- Do not submerge the unit in water. Do not pour or spray water directly on it to clean. The unit is not waterproof and covering it with water will damage it and void the warranty.
- Always remove power before cleaning.
- When cleaning, use only damp soft cloths or plastic scouring pads for cleaning cloth and a mild non-abrasive detergent.
- Do not use wire brushes, abrasives, or cleaning tools such as steel pads and scrapers, which will scratch the painted surface.
- When possible use treated water. Hard water can leave behind deposits. Soft water is much gentler on the painted steel's surface.
- Avoid the use of acetone, thinner, or other volatile solvents and abrasive type cleaners for cleaning. If required, a mild solvent such as mineral spirits can be used to remove oil, grease, tars, wax, and similar substances. Uses a cloth dampened with mineral spirits, and apply only to contaminated areas. Follow up the use of this mild solvent with detergent cleaning and rinsing.

# PARTS IDENTIFICATION

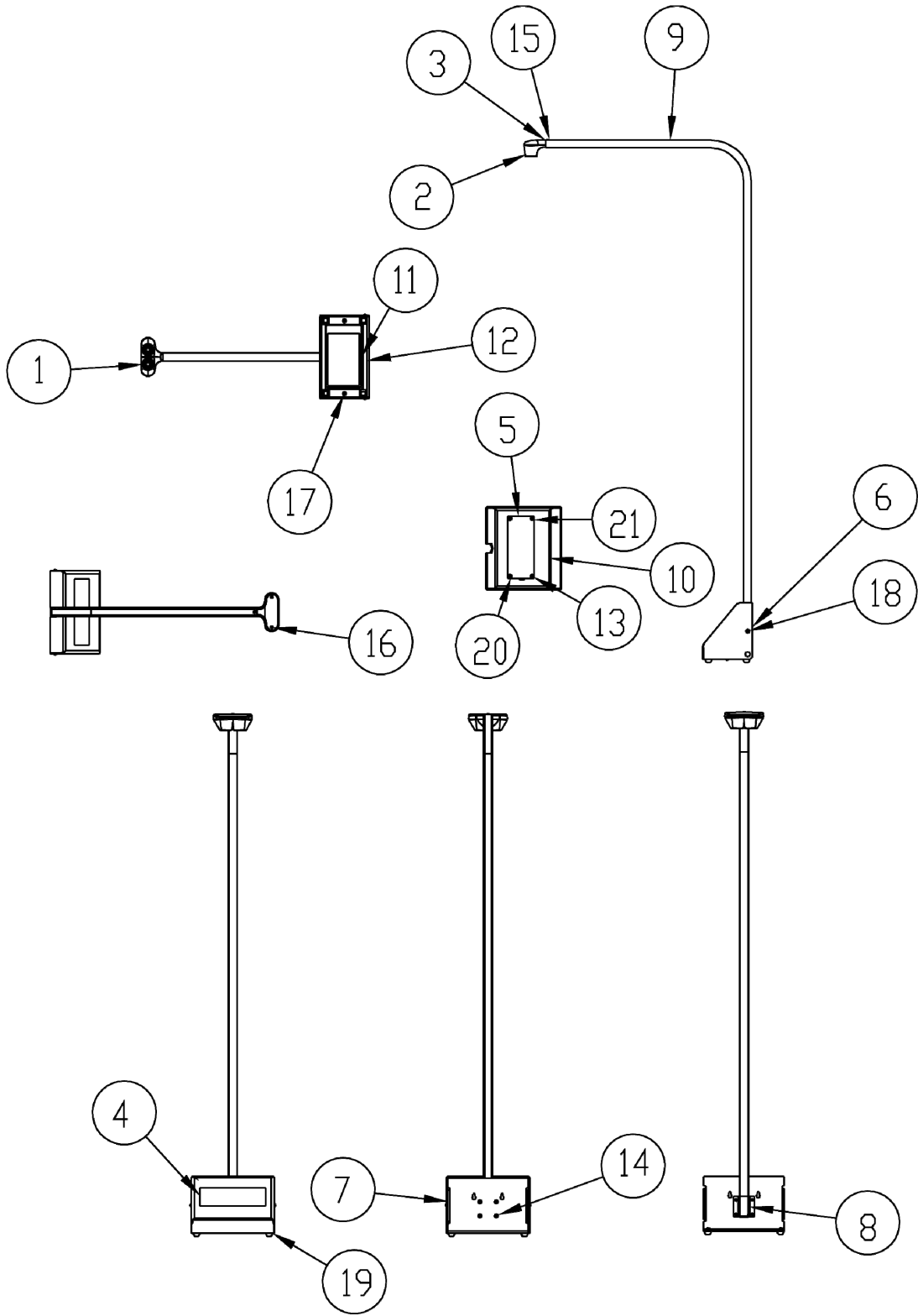

## PARTS IDENTIFICATION, CONT.

Item	Qty.	Part Number	Description
1	1	3300-0039-2A	PCB ASS'Y SONARIS ULTRASONIC HEIGHT SENSOR
2	1	3300-0060-08	SONAR FRONT ENCLOSURE
3	1	3300-0061-08	SONAR REAR ENCLOSURE
4	1	3300-0252-08	KEYPAD, SONARIS
5	1	3300-0253-0A	PCB ASS'Y SONARIS
6	1	3300-0273-08	SONARIS OUTSIDE COVER
7	1	3300-0275-08	SONARIS BACK COVER
8	1	3300-0309-08	SONARIS CLAMP
9	1	3300-0310-08	SONARIS HEIGHT SENSOR TUBE
10	1	3300-0311-0A	SONARIS INSIDE COVER ASSEMBLY
11	1	3300-0314-0A	SONARIS CABLE ASSEMBLY
12	1	3300-0315-08	SONARIS BATTERY PLATE
13	4	6013-0315	NUT #6-32 HEX SMALL PATTERN Z/P
14	4	6021-0697	SCW FLAT-HEAD, SHEET METAL #6X.375 PHIL DRIVE
15	1	6021-1293	SCW FLAT-HEAD THREAD CUTTING TYPE 25, #4-24 X 1/4, PHIL. DR. Z-PLATE
16	2	6021-2078	SCW PAN HEAD PHILIPS #1-32X3/8" THREAD FORMING, 18-8 SS
17	2	6021-6017	SCW ROUND-HEAD BLUNT SS. SHEET METAL #6X.25
18	2	6021-6501	SCW ROUND-HEAD SHEET METAL-SWC #6X.375, Z/P
19	4	6540-0001	RUBBER FOOT .50 SQ X .23 HIGH
20	4	6680-0004	WASHER LOCK INT TOOTH #6 TYPE A Z-PL
21	4	6680-0045	SPACER, #6 X 0.052
*	1	6800-1045	AC ADAPTER 100-240VAC/12VDC @ 1 AMP

\* NOT SHOWN

## STATEMENT OF LIMITED WARRANTY

Detecto Scale warrants its equipment to be free from defects in material and workmanship as follows: Detecto warrants to the original purchaser only that it will repair or replace any part of equipment, which is defective in material or workmanship for a period of two **(2) years from date of shipment**. Detecto shall be the sole judge of what constitutes a defect.

During the **first ninety (90) days**, Detecto may choose to replace the product at no charge to the buyer upon inspection of the returned item.

**After the first ninety (90) days**, upon inspection of the returned item, Detecto will repair or replace it with a remanufactured product. The customer is responsible for paying for the freight both ways.

This warranty does not apply to peripheral equipment not manufactured by Detecto; this equipment will be covered by certain manufacturer's warranty only.

This warranty does not include replacement of expendable or consumable parts. This does not apply to any item, which has deteriorated or damaged due to wear, accident, misuse, abuse, improper line voltage, overloading, theft, lightning, fire, water, or acts of God, or due to extended storage or exposure while in purchaser's possession. This warranty does not apply to maintenance service. Purchased parts will have a ninety (90) day repair or replacement warranty only.

Detecto may require the suspect product to be returned to the factory; item(s) must be properly packed and shipping charges prepaid. A return authorization number must be obtained for all returns and marked on the outside of all returned packages. Detecto accepts no responsibility for loss or damage in transit.

# STATEMENT OF LIMITED WARRANTY

## Conditions Which Void Limited Warranty

This warranty shall not apply to equipment which:

- A.) Has been tampered with, defaced, mishandled or has had repairs and modifications not authorized by Detecto.
- B.) Has had serial number altered, defaced, or removed.
- C.) Has not been grounded according to Detecto's recommended procedure.

## Freight Carrier Damage

Claims for equipment damaged in transit must be referred to the freight carrier in accordance with freight carrier regulations.

This warranty sets forth the extent of our liability for breach of any warranty or deficiency in connection with the sale or use of the product. Detecto will not be liable for consequential damages of any nature, including but not limited to, loss of profit, delays, or expenses, whether based on tort or contract. Detecto reserves the right to incorporate improvements in material and design without notice and is not obligated to incorporate improvements in equipment previously manufactured.

The foregoing is in lieu of all other warranties, express or implied including any warranty that extends beyond the description of the product including any warranty of merchantability or fitness for a particular purpose. This warranty covers only those Detecto products installed in the forty-eight (48) contiguous continental United States.



08/27/2014  
Printed in USA  
D268-WARRANTY-DET-A



Printed in USA

3300-0317-0M Rev B 04/18