

**NOTES:**

**MATERIAL:**  
STEEL WITH 2.0mm LEAD EQUIVALENCE

**PAD PRINT COLOR:**  
2.0mm LEAD EQUIVALENCE GLASS

**FRAME COLOR:**  
TAN

NOT TO SCALE

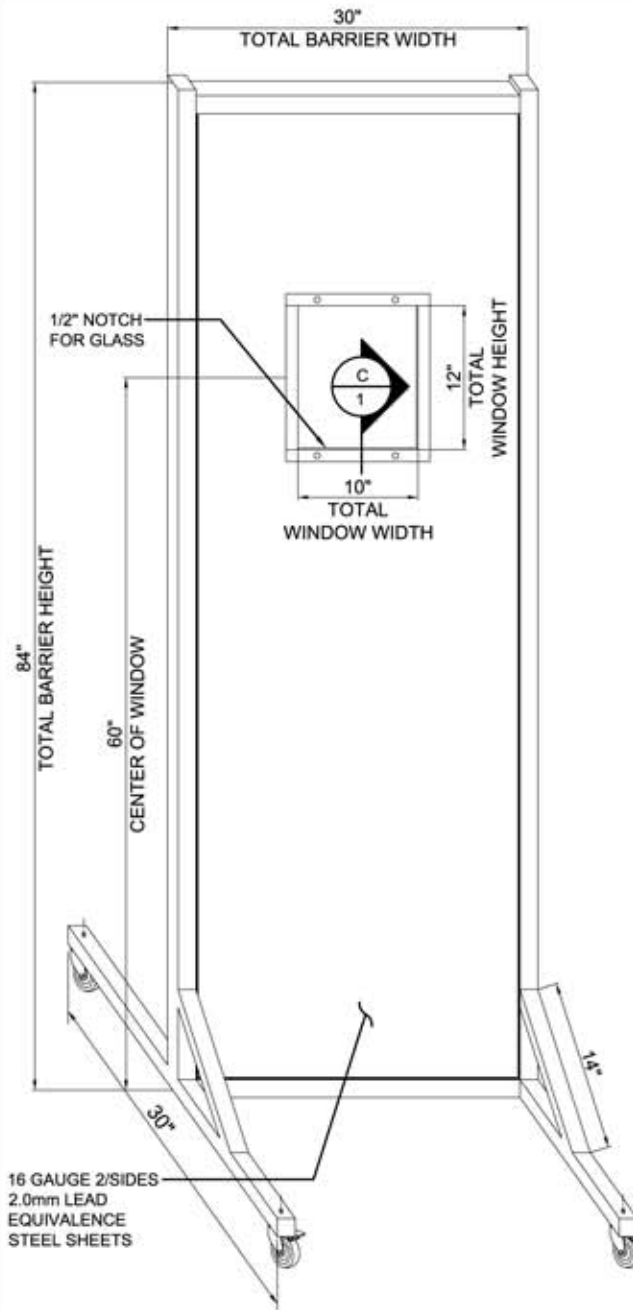

**(A) BARRIER ELEVATION**

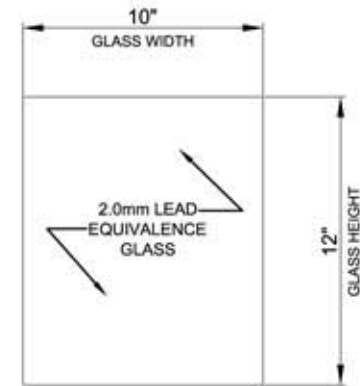

**(B) GLASS ELEVATION**

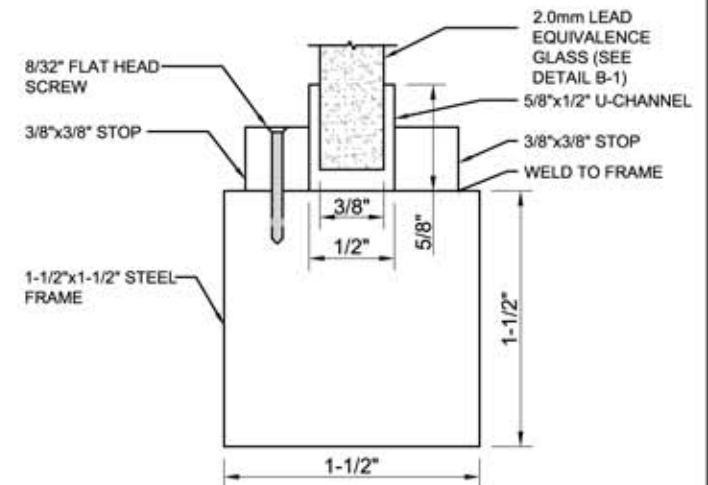

**(C) SECTION AT FRAME**

	DWG No.	Rev.
	LB-3084	
	P/N:	
	LB-3084	
	DESC.	
	Opaque Mobile Leaded Barrier 30 in. x 84 in	