

NOTES:

MATERIAL:  
STEEL WITH 2.0mm LEAD  
EQUIVALENCE

PAD PRINT COLOR:  
2.0mm LEAD  
EQUIVALENCE GLASS

FRAME COLOR:  
TAN

NOT TO SCALE

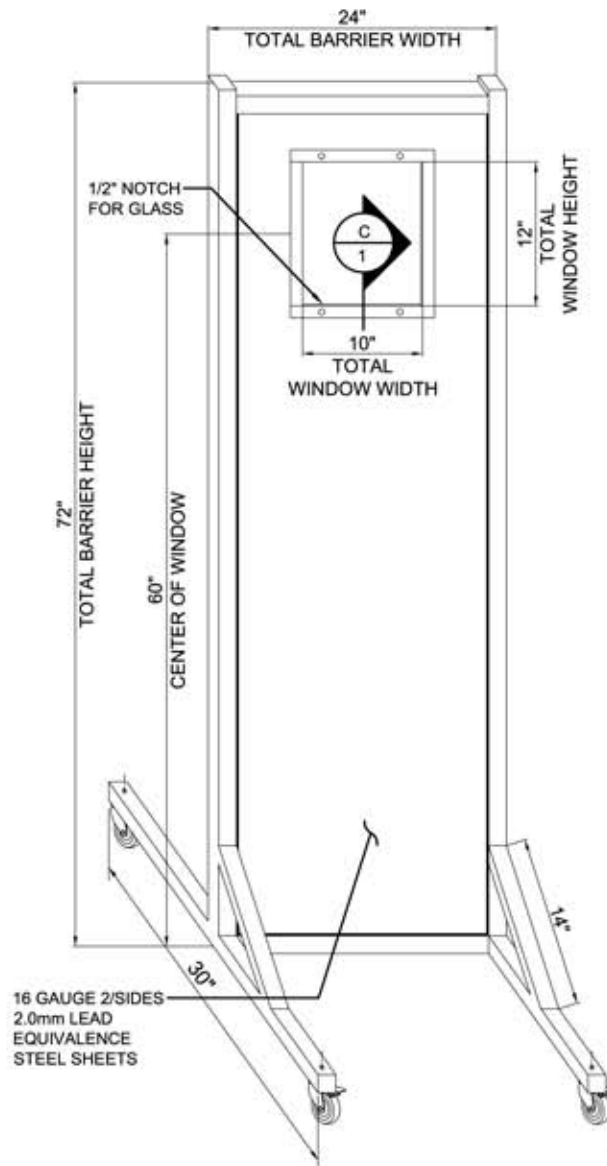

(A) BARRIER ELEVATION  
1

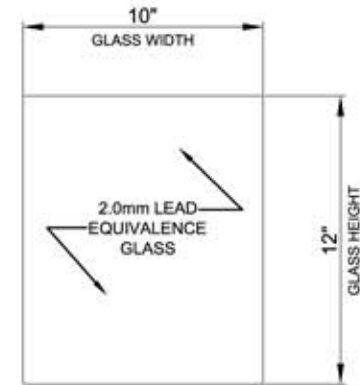

(B) GLASS ELEVATION  
1

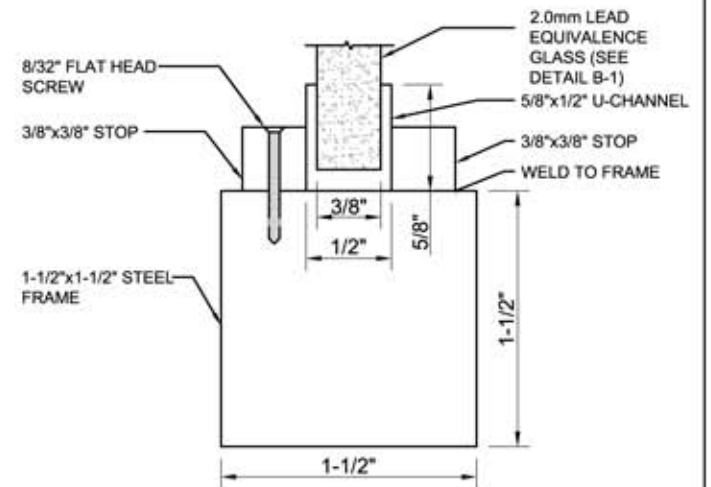

(C) SECTION AT FRAME  
1

	DWG No.	LB-2472	Rev.
	P/N:	LB-2472	
	DESC.	Opaque Mobile Leaded Barrier 24 in. x 72 in	